

METAL FABRICATION, INDUSTRIAL & CONSTRUCTION
PRODUCT CATALOG



Where Quality, Performance & Value - Come Together!



PRECISION & ROUGH GRINDING • CUTTING • FINISHING • BLENDING



Where Quality, Performance & Value – Come Together!

WHO IS CGW ABRASIVES – OUR STORY

History: Founded in Israel in 1956. Established U.S. operations in 1990. We are oSa certified and proud to maintain the highest quality in our manufacturing standards. Leading manufacturer of premium grinding wheels, cutting wheels, flap discs, coated abrasives, and vitrified products. We also do private label programs for many of our North American customers. We offer both price point and premium products in most specifications.

MARKETS

CGW Abrasives has more than 60 years of experience and sells products in more than 50 countries. Active in various industries, including:

- Metal Fabrication
- Automotive
- Aerospace
- Construction
- MRO
- Bearing
- Industrial
- Cutting Tools
- General Metal Working

CGW WORLDWIDE



OUR COMPANY

Established in 1956 in Sarid, Israel.

- 5 manufacturing plants in **Chicago, California and Israel;** approximately 400,000 sq. ft. total
- Training facilities in Chicago & California



OUR PEOPLE

- Over 300 employees
- Extensive field sales and technical application support



OUR PROMISE

- **Quality** products
- Superior **performance**
- **Value** you can trust



OUR RESEARCH & SERVICE

- R&D: large technical staff; **world-class testing facilities**
- 3,000+ stock items that ship **same day/next day**

SAFETY & MANUFACTURING

All products are recognized by the highest safety and manufacturing standards:



The Standards Institution of Israel (SII)

TABLE OF CONTENTS

FLAP DISCS	4
eXtreme™ C3 Ceramic Flap Discs BEST	5
eXtra™ Z3® Zirconia Flap Discs BETTER	6
<i>Fast Cut</i> Z-PC Zirconia Flap Discs GOOD	9
SPECIALTY FLAP DISCS	10
SEMI-FLEX DISCS	18
FIBER DISCS	19
QUICK CHANGE DISCS	22
CUTTING WHEELS	24
eXtreme Cut™ .045" Ceramic BEST	25
Quickie Cut™ .045" Zirconia AO BETTER	26
<i>Fast Cut</i> .045" Aluminum Oxide GOOD	27
GRINDING WHEELS	36
eXtreme Grind™ 1/4" Grinding Wheels BEST	36
Ultra 1/4" Depressed Center Grinding Wheels BETTER	37
<i>Fast Cut</i> 1/4" Depressed Center Grinding Wheels GOOD	38
SANDING DISCS	42
SHOP ROLLS	46
SHEETS, SPONGES & HAND PADS	48
BELTS	50
CGW EXPRESS Made-to-Order & Stock Belts	
SURFACE CONDITIONING	54
FLAP WHEELS	56
COATED SPECIALTIES	60
Spiral Bands, Rubber Expanding Drums, Cross Pads, Cartridge Rolls, Mandrels	
WIRE BRUSHES	62
CARBIDE BURS	68
RESIN CONES, PLUGS & CUP WHEELS	72
DIAMOND WHEELS	73
PRECISION GRINDING / VITRIFIED WHEELS	74
CONVOLUTE, DEBURRING, UNITIZED WHEELS	88

ALPHABETICAL INDEX

Belts	50
Bench & Pedestal Wheels	81
Blanchard Grinding Segments	80
Carbide Burs	68
Cartridge Rolls	61
Centerless, Cylindrical Wheels	83
Chop & Gas Saw	33
Circular & Stationary Saw	32
Convolute, Deburring, Unitized Wheels	88
Cross Pads	60
Cutting Wheels (.045")	25
Diamond Wheels, Demolition Blade	73
Die Grinder Wheels	30
Discs - Paper, Cloth, Film	42
Dressing Wheels, Sticks, Bushings	82
EZ Strip Wheels	55
Feed Regulating Wheels	85
Fiber Discs	19
Flap Discs	4
Flap Wheels	56
Grinding Wheels	36
Hand Pads	49
ID (Internal Dimension) Wheels	87
Mandrels	61
Mounted Points	87
Precision Grinding (Vitrified)	74
Quick Change Discs	22
Resin Cones, Plugs & Cup Wheels	72
Semi-Flex Discs	18
Sheets, Sponges	48
Shop Rolls	46
Specialty Flap Discs	10
Spiral Bands, Rubber Expanding Drums	60
Surface Conditioning Belts	54
Surface Grinding Wheels	76
Tool & Cutter Wheels	86
Wire Brushes	62

FLAP DISCS



Tier	Trade Name	Spec	Grain	Performance	Application
BEST	<i>eXtreme</i>	C3	Ceramic	High Productivity	Metal/Welds, Stainless Steel, Titanium
BETTER	<i>eXtra</i>	Z3	Zirconia	All Purpose #1 Seller	Metal/Welds, Carbon Steel, Stainless Steel
GOOD	<i>Fast Cut</i>	Z-PC	Zirconia Blend	Good Value	Metal/Welds, Carbon Steel, Stainless Steel
SPECIALTY	Plastic Hub	C3	Ceramic	High Productivity	Metal, Stainless Steel, Titanium
		Z3	Zirconia	All Purpose #1 Seller	Metal, Carbon Steel, Stainless Steel
	Z-Stainless	ZS	Zirconia w/Grind Aid	Application Specific	Stainless Steel
	Silicon Carbide	SC	Silicon Carbide	Application Specific	Granite, Marble, Titanium, Plastics
	Aluminum	A3	Aluminum Oxide	Application Specific	Non Ferrous, Soft Metals, Brass, Copper, Zinc, Alum
		ALU	AO w/Grinding Aid		Aluminum, Soft Metals
	Mini	Z3	Zirconia	Tight Areas	Steel/Stainless
Corner	Z3	Zirconia	Corners	Steel/Stainless	

Flap Disc Material Comparison

Type 27

Type 27 (flat) choice for smooth finishing

Type 29

Type 29 (conical angle) choice for stock removal

Compact (hybrid angle) for rough edge work

Flap Disc Type



Regular – Fast removal rate for aggressive use and heavy duty applications.

Edge Grinding



Compact – Hybrid compact disc design – Flaps are compressed and compacted at a 4 degree angle. **20% more material** than regular flap discs.

Production Grinding



XL – Approximately **35% more material** than regular flap discs.

FLAP DISCS



eXtreme C3 Ceramic Flap Discs

BEST

- Self-sharpening high performance ceramic grain with a grinding aid for fast, aggressive cutting action.
- Ceramic flap discs are designed to last longer than zirconia flap discs.
- Polyester backing material for extra long life.
- Ceramic grain provides Contaminant-Free results; stainless steel will not rust.
- Hybrid Compact design (4-1/2" and 5") – Flaps are compressed and compacted at a 4 degree for edge strength.
- For steel and stainless and other heat sensitive materials.



7/8 arbor 5/8-11 hub

CERAMIC

UPC	Size	Type	RPM	Grit	Box / Master
Compact Regular					
4-1/2 x 7/8					
42401	4-1/2 x 7/8	Compact	13,300	36	10 / 100
42402	4-1/2 x 7/8	Compact	13,300	40	10 / 100
42404	4-1/2 x 7/8	Compact	13,300	60	10 / 100
42405	4-1/2 x 7/8	Compact	13,300	80	10 / 100
4-1/2 x 5/8-11					
42411	4-1/2 x 5/8-11	Compact	13,300	36	10 / 100
42412	4-1/2 x 5/8-11	Compact	13,300	40	10 / 100
42414	4-1/2 x 5/8-11	Compact	13,300	60	10 / 100
42415	4-1/2 x 5/8-11	Compact	13,300	80	10 / 100
5 x 7/8					
42601	5 x 7/8	Compact	12,200	36	10 / 100
42602	5 x 7/8	Compact	12,200	40	10 / 100
42604	5 x 7/8	Compact	12,200	60	10 / 100
42605	5 x 7/8	Compact	12,200	80	10 / 100
Compact XL					
4-1/2 x 7/8					
42441	4-1/2 x 7/8	XL Compact	13,300	36	10 / 100
42442	4-1/2 x 7/8	XL Compact	13,300	40	10 / 100
42444	4-1/2 x 7/8	XL Compact	13,300	60	10 / 100
42445	4-1/2 x 7/8	XL Compact	13,300	80	10 / 100
4-1/2 x 5/8-11					
42451	4-1/2 x 5/8-11	XL Compact	13,300	36	10 / 100
42452	4-1/2 x 5/8-11	XL Compact	13,300	40	10 / 100
42454	4-1/2 x 5/8-11	XL Compact	13,300	60	10 / 100
42455	4-1/2 x 5/8-11	XL Compact	13,300	80	10 / 100
5 x 7/8					
42641	5 x 7/8	XL Compact	12,200	36	10 / 100
42642	5 x 7/8	XL Compact	12,200	40	10 / 100
42644	5 x 7/8	XL Compact	12,200	60	10 / 100

UPC	Size	Type	RPM	Grit	Box / Master
Regular, Type 27					
7 x 7/8					
42801	7 x 7/8	T27	8,600	36	10 / 120
42802	7 x 7/8	T27	8,600	40	10 / 120
42804	7 x 7/8	T27	8,600	60	10 / 120
42805	7 x 7/8	T27	8,600	80	10 / 120
7 x 5/8-11					
42811	7 x 5/8-11	T27	8,600	36	10 / 60
42812	7 x 5/8-11	T27	8,600	40	10 / 60

UPC	Size	Type	RPM	Grit	Box / Master
Regular, Type 29					
7 x 7/8					
42821	7 x 7/8	T29	8,600	36	10 / 120
42822	7 x 7/8	T29	8,600	40	10 / 120
7 x 5/8-11					
42831	7 x 5/8-11	T29	8,600	36	10 / 60
42832	7 x 5/8-11	T29	8,600	40	10 / 60

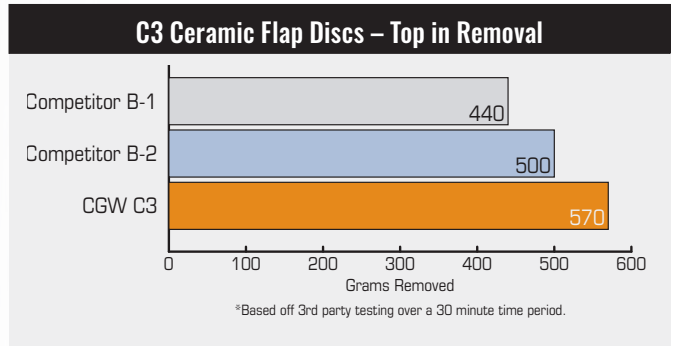

Other sizes available as made-to-order. Contact customer service.

eXtra Z3[®] Zirconia Flap Discs

BETTER

USA
MADE

CFE
CONTAMINANT-FREE
Iron, Sulfur, and
Chlorine ≤ 0.1%



- Premium Zirconia Alumina grain on a poly/cotton backing. The poly/cotton combination provides both durability and finish while the Zirconia concentration provides high stock removal.
- Fastest stock removal in the marketplace for steel applications.
- Recommended for aggressive use and heavy duty applications.
- Active grinding aid provides cool cutting with light pressure.
- **XL** 35% more material than regular flap disc.

#1 PERFORMER ON STEEL

#1 Selling
Flap Disc



XL flap disc, T27



Regular flap disc, T29

42332

Z3[®] Zirconia Flap Discs – Type 27

Regular UPC	XL UPC	Size	Type	Grit	RPM	Box / Master
Z3[®] Type 27						
4 x 5/8						
42101		4 x 5/8	T27	24	15,300	10 / 200
42102		4 x 5/8	T27	36	15,300	10 / 200
42103	42142 XL	4 x 5/8	T27	40	15,300	10 / 200
42104	42144 XL	4 x 5/8	T27	60	15,300	10 / 200
42105	42145 XL	4 x 5/8	T27	80	15,300	10 / 200
42106	42146 XL	4 x 5/8	T27	120	15,300	10 / 200
4 x 3/8-24						
42111		4 x 3/8-24	T27	36	15,300	10 / 200
42112		4 x 3/8-24	T27	40	15,300	10 / 200
42114		4 x 3/8-24	T27	60	15,300	10 / 200
4-1/2 x 7/8						
42300		4-1/2 x 7/8	T27	24	13,300	10 / 100
42301	42341 XL	4-1/2 x 7/8	T27	36	13,300	10 / 100
42302	42342 XL	4-1/2 x 7/8	T27	40	13,300	10 / 100
42304	42344 XL	4-1/2 x 7/8	T27	60	13,300	10 / 100
42305	42345 XL	4-1/2 x 7/8	T27	80	13,300	10 / 100
42306	42346 XL	4-1/2 x 7/8	T27	120	13,300	10 / 100
4-1/2 x 5/8-11						
42310		4-1/2 x 5/8-11	T27	24	13,300	10 / 100
42311	42351 XL	4-1/2 x 5/8-11	T27	36	13,300	10 / 100
42312	42352 XL	4-1/2 x 5/8-11	T27	40	13,300	10 / 100
42314	42354 XL	4-1/2 x 5/8-11	T27	60	13,300	10 / 100
42315	42355 XL	4-1/2 x 5/8-11	T27	80	13,300	10 / 100
42316	42356 XL	4-1/2 x 5/8-11	T27	120	13,300	10 / 100
5 x 7/8						
42500		5 x 7/8	T27	24	12,200	10 / 100
42501	42541 XL	5 x 7/8	T27	36	12,200	10 / 100
42502	42542 XL	5 x 7/8	T27	40	12,200	10 / 100
42504	42544 XL	5 x 7/8	T27	60	12,200	10 / 100
42505	42545 XL	5 x 7/8	T27	80	12,200	10 / 100



ZIRCONIA

Regular UPC	XL UPC	Size	Type	Grit	RPM	Box / Master
5 x 5/8-11						
42510		5 x 5/8-11	T27	24	12,200	10 / 100
42511	42551 XL	5 x 5/8-11	T27	36	12,200	10 / 100
42512	42552 XL	5 x 5/8-11	T27	40	12,200	10 / 100
42514	42554 XL	5 x 5/8-11	T27	60	12,200	10 / 100
42515		5 x 5/8-11	T27	80	12,200	10 / 100
42516		5 x 5/8-11	T27	120	12,200	10 / 100
6 x 7/8						
53001	53041 XL	6 x 7/8	T27	36	10,200	10 / 120
53002	53042 XL	6 x 7/8	T27	40	10,200	10 / 120
53004	53044 XL	6 x 7/8	T27	60	10,200	10 / 120
53005	53045 XL	6 x 7/8	T27	80	10,200	10 / 120
53006		6 x 7/8	T27	120	10,200	10 / 120
6 x 5/8-11						
53011	53051 XL	6 x 5/8-11	T27	36	10,200	10 / 60
53012	53052 XL	6 x 5/8-11	T27	40	10,200	10 / 60
53014	53054 XL	6 x 5/8-11	T27	60	10,200	10 / 60
53015	53055 XL	6 x 5/8-11	T27	80	10,200	10 / 60
	53056 XL	6 x 5/8-11	T27	120	10,200	10 / 60
7 x 7/8						
42700		7 x 7/8	T27	24	8,600	10 / 120
42701		7 x 7/8	T27	36	8,600	10 / 120
42702	42742 XL	7 x 7/8	T27	40	8,600	10 / 120
42704	42744 XL	7 x 7/8	T27	60	8,600	10 / 120
42705	42745 XL	7 x 7/8	T27	80	8,600	10 / 120
42706		7 x 7/8	T27	120	8,600	10 / 120
7 x 5/8-11						
42710		7 x 5/8-11	T27	24	8,600	10 / 60
42711		7 x 5/8-11	T27	36	8,600	10 / 60
42712	42752 XL	7 x 5/8-11	T27	40	8,600	10 / 60
42714	42754 XL	7 x 5/8-11	T27	60	8,600	10 / 60
42715	42755 XL	7 x 5/8-11	T27	80	8,600	10 / 60
42716		7 x 5/8-11	T27	120	8,600	10 / 60

Other sizes available as made-to-order.
Contact customer service.

Z3® Zirconia Flap Discs – Type 29



ZIRCONIA



Regular UPC	XL UPC	Size	Type	Grit	RPM	Box / Master
Z3® Type 29						
4 x 5/8						
42120		4 x 5/8	T29	24	15,300	10 / 200
42121	42161 XL	4 x 5/8	T29	36	15,300	10 / 200
42122	42162 XL	4 x 5/8	T29	40	15,300	10 / 200
42124	42164 XL	4 x 5/8	T29	60	15,300	10 / 200
42125	42165 XL	4 x 5/8	T29	80	15,300	10 / 200
4 x 3/8-24						
42131		4 x 3/8-24	T29	36	15,300	10 / 200
42132		4 x 3/8-24	T29	40	15,300	10 / 200
42134		4 x 3/8-24	T29	60	15,300	10 / 200
42135		4 x 3/8-24	T29	80	15,300	10 / 200
4-1/2 x 7/8						
42320		4-1/2 x 7/8	T29	24	13,300	10 / 100
42321	42361 XL	4-1/2 x 7/8	T29	36	13,300	10 / 100
42322	42362 XL	4-1/2 x 7/8	T29	40	13,300	10 / 100
42324	42364 XL	4-1/2 x 7/8	T29	60	13,300	10 / 100
42325	42365 XL	4-1/2 x 7/8	T29	80	13,300	10 / 100
42326	42366 XL	4-1/2 x 7/8	T29	120	13,300	10 / 100
4-1/2 x 5/8-11 w/Hub						
42330		4-1/2 x 5/8-11	T29	24	13,300	10 / 100
42331	42371 XL	4-1/2 x 5/8-11	T29	36	13,300	10 / 100
42332	42372 XL	4-1/2 x 5/8-11	T29	40	13,300	10 / 100
42334	42374 XL	4-1/2 x 5/8-11	T29	60	13,300	10 / 100
42335	42375 XL	4-1/2 x 5/8-11	T29	80	13,300	10 / 100
42336	42376 XL	4-1/2 x 5/8-11	T29	120	13,300	10 / 100
5 x 7/8						
42520		5 x 7/8	T29	24	12,200	10 / 100
42521	42561 XL	5 x 7/8	T29	36	12,200	10 / 100
42522	42562 XL	5 x 7/8	T29	40	12,200	10 / 100
42524	42564 XL	5 x 7/8	T29	60	12,200	10 / 100
42525	42565 XL	5 x 7/8	T29	80	12,200	10 / 100
42526	42566 XL	5 x 7/8	T29	120	12,200	10 / 100

Regular UPC	XL UPC	Size	Type	Grit	RPM	Box / Master
5 x 5/8-11 w/Hub						
42531	42571 XL	5 x 5/8-11	T29	36	12,200	10 / 100
42532	42572 XL	5 x 5/8-11	T29	40	12,200	10 / 100
42534	42574 XL	5 x 5/8-11	T29	60	12,200	10 / 100
	42575 XL	5 x 5/8-11	T29	80	12,200	10 / 100
6 x 7/8						
53021	53061 XL	6 x 7/8	T29	36	10,200	10 / 120
53022	53062 XL	6 x 7/8	T29	40	10,200	10 / 120
53024	53064 XL	6 x 7/8	T29	60	10,200	10 / 120
53025	53065 XL	6 x 7/8	T29	80	10,200	10 / 120
53026	53066 XL	6 x 7/8	T29	120	10,200	10 / 120
6 x 5/8-11 w/Hub						
53031	53071 XL	6 x 5/8-11	T29	36	10,200	10 / 60
53032	53072 XL	6 x 5/8-11	T29	40	10,200	10 / 60
53034	53074 XL	6 x 5/8-11	T29	60	10,200	10 / 60
53035	53075 XL	6 x 5/8-11	T29	80	10,200	10 / 60
	53076 XL	6 x 5/8-11	T29	120	10,200	10 / 60
7 x 7/8						
42720		7 x 7/8	T29	24	8,600	10 / 120
42721		7 x 7/8	T29	36	8,600	10 / 120
42722	42762 XL	7 x 7/8	T29	40	8,600	10 / 120
42724	42764 XL	7 x 7/8	T29	60	8,600	10 / 120
42725	42765 XL	7 x 7/8	T29	80	8,600	10 / 120
7 x 5/8-11 w/Hub						
42730		7 x 5/8-11	T29	24	8,600	10 / 60
42731		7 x 5/8-11	T29	36	8,600	10 / 60
42732	42772 XL	7 x 5/8-11	T29	40	8,600	10 / 60
42734	42774 XL	7 x 5/8-11	T29	60	8,600	10 / 60
42735	42775 XL	7 x 5/8-11	T29	80	8,600	10 / 60

Other sizes available as made-to-order.
Contact customer service.

More Material – Longer Life



Regular



XL

- XL Approximately 35% more material than Regular.

Z3® Ultimate WIDER & XTRA Material

BETTER

WIDER

- Z3® Ultimate flap discs allow the material to further spread out reducing heat generation for easier break down compared to XL discs.
- Z3® Ultimate Flap Discs - extra wide material width – 25% more material than regular flap discs.
- Unique flap design structure – cushion-like impact for more controlled stock removal and more consistent finishing results.



54031

Side View

Type 27

Type 29

UPC	Size	Type	Grit	RPM	Box / Master
Type 27					
54001	4-1/2 x 7/8	T27	36	13,300	10 / 100
54002	4-1/2 x 7/8	T27	40	13,300	10 / 100
54004	4-1/2 x 7/8	T27	60	13,300	10 / 100
54005	4-1/2 x 7/8	T27	80	13,300	10 / 100
54011	4-1/2 x 5/8-11	T27	36	13,300	10 / 100
54012	4-1/2 x 5/8-11	T27	40	13,300	10 / 100
54014	4-1/2 x 5/8-11	T27	60	13,300	10 / 100
54015	4-1/2 x 5/8-11	T27	80	13,300	10 / 100

UPC	Size	Type	Grit	RPM	Box / Master
Type 29					
54021	4-1/2 x 7/8	T29	36	13,300	10 / 100
54022	4-1/2 x 7/8	T29	40	13,300	10 / 100
54024	4-1/2 x 7/8	T29	60	13,300	10 / 100
54025	4-1/2 x 7/8	T29	80	13,300	10 / 100
54031	4-1/2 x 5/8-11	T29	36	13,300	10 / 100
54032	4-1/2 x 5/8-11	T29	40	13,300	10 / 100
54034	4-1/2 x 5/8-11	T29	60	13,300	10 / 100
54035	4-1/2 x 5/8-11	T29	80	13,300	10 / 100

36, 40 grits use extra material only.

Z3® Double/XXL Flap Discs

- 45% more material than regular flap discs.
- Designed for easy working on angled surfaces.
- **Extra wide flaps** for longer working life.
- **XXL** (15% more material than XL) requires high output angle grinders for best results.



Side View

Type 27

Type 29

UPC	Size	Density	Type	Grit	RPM	Box / Master
Type 27						
4-1/2 x 7/8						
36316	4-1/2 x 7/8	XXL	T27	40	13,300	10 / 100
36317	4-1/2 x 7/8	XXL	T27	60	13,300	10 / 100
36318	4-1/2 x 7/8	XXL	T27	80	13,300	10 / 100
4-1/2 x 5/8-11						
36319	4-1/2 x 5/8-11	XXL	T27	40	13,300	10 / 100
36320	4-1/2 x 5/8-11	XXL	T27	60	13,300	10 / 100
36321	4-1/2 x 5/8-11	XXL	T27	80	13,300	10 / 100

UPC	Size	Density	Type	Grit	RPM	Box / Master
Type 29						
4-1/2 x 7/8						
36322	4-1/2 x 7/8	XXL	T29	40	13,300	10 / 100
36323	4-1/2 x 7/8	XXL	T29	60	13,300	10 / 100
36324	4-1/2 x 7/8	XXL	T29	80	13,300	10 / 100
4-1/2 x 5/8-11						
36325	4-1/2 x 5/8-11	XXL	T29	40	13,300	10 / 100
36326	4-1/2 x 5/8-11	XXL	T29	60	13,300	10 / 100
36327	4-1/2 x 5/8-11	XXL	T29	80	13,300	10 / 100

Other sizes available as made-to-order.
Contact customer service.

Fast Cut Z-PC Flap Discs

GOOD

- Zirconia grain with a poly/cotton backing. The poly/cotton backing provides both durability and finish strength.
- For steel applications.
- **XL** Requires high output angle grinders for best results.

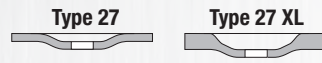

Regular UPC	XL UPC	Size	Type	Grit	RPM	Box / Master
Type 27						
4-1/2 x 7/8						
41701	41741 XL	4-1/2 x 7/8	T27	36	13,300	10 / 100
41702	41742 XL	4-1/2 x 7/8	T27	40	13,300	10 / 100
41704	41744 XL	4-1/2 x 7/8	T27	60	13,300	10 / 100
41705	41745 XL	4-1/2 x 7/8	T27	80	13,300	10 / 100
41706	41746 XL	4-1/2 x 7/8	T27	120	13,300	10 / 100



Regular UPC	XL UPC	Size	Type	Grit	RPM	Box / Master
Type 29						
4-1/2 x 7/8						
41721	41761 XL	4-1/2 x 7/8	T29	36	13,300	10 / 100
41722	41762 XL	4-1/2 x 7/8	T29	40	13,300	10 / 100
41724	41764 XL	4-1/2 x 7/8	T29	60	13,300	10 / 100
41725	41765 XL	4-1/2 x 7/8	T29	80	13,300	10 / 100
41726	41766 XL	4-1/2 x 7/8	T29	120	13,300	10 / 100
4-1/2 x 5/8-11						
41731	41771 XL	4-1/2 x 5/8-11	T29	36	13,300	10 / 100
41732	41772 XL	4-1/2 x 5/8-11	T29	40	13,300	10 / 100
41734	41774 XL	4-1/2 x 5/8-11	T29	60	13,300	10 / 100
41735		4-1/2 x 5/8-11	T29	80	13,300	10 / 100
41736		4-1/2 x 5/8-11	T29	120	13,300	10 / 100

Other sizes available as made-to-order. Contact customer service.



Regular UPC	XL UPC	Size	Type	Grit	RPM	Box / Master
4-1/2 x 5/8-11						
41711	41751 XL	4-1/2 x 5/8-11	T27	36	13,300	10 / 100
41712	41752 XL	4-1/2 x 5/8-11	T27	40	13,300	10 / 100
41714	41754 XL	4-1/2 x 5/8-11	T27	60	13,300	10 / 100
41715		4-1/2 x 5/8-11	T27	80	13,300	10 / 100
41716		4-1/2 x 5/8-11	T27	120	13,300	10 / 100
7 x 5/8-11						
41952	41992 XL	7 x 5/8-11	T27	40	8,600	10 / 60
41954		7 x 5/8-11	T27	60	8,600	10 / 60
41955		7 x 5/8-11	T27	80	8,600	10 / 60

Regular UPC	XL UPC	Size	Type	Grit	RPM	Box / Master
5 x 7/8						
41802	41842 XL	5 x 7/8	T29	40	12,200	10 / 100
41804	41844 XL	5 x 7/8	T29	60	12,200	10 / 100
41805	41845 XL	5 x 7/8	T29	80	12,200	10 / 100
7 x 7/8						
41962	42002 XL	7 x 7/8	T29	40	8,600	10 / 120
41964		7 x 7/8	T29	60	8,600	10 / 120
41965		7 x 7/8	T29	80	8,600	10 / 120
7 x 5/8-11						
41971		7 x 5/8-11	T29	36	8,600	10 / 60
41972	42012 XL	7 x 5/8-11	T29	40	8,600	10 / 60
41974		7 x 5/8-11	T29	60	8,600	10 / 60

More Material – Longer Life



Regular

XL

- **XL** Approximately **35%** more material than Regular.



SPECIALTY FLAP DISCS

USA
MADE

CFE
CONTAMINANT-FREE
Iron, Sulfur, and
Chlorine ≤ 0.1%



PLASTIC FLAP DISCS

Plastic Backing Flap Discs with Internal 5/8-11 Threads

- C3 (Ceramic) has 20% more material than regular flap discs.
- Z3 (Zirconia) has 20% more material than regular flap disc.
- Hybrid **compact design** (4-1/2", 5" and 6") – Flaps are compressed and compacted at a 4 degree angle for edge strength and longer life.



30146



side view

C3 (Ceramic) for aggressive cutting action. Self-sharpening ceramic grain and cool grinding aid. Ideal for hard-to-grind materials including steel and other heat sensitive materials.

Z3® (Zirconia) for fast, long-lasting grinding. Ideal for heavy-duty applications.

CERAMIC

ZIRCONIA

UPC	Size	RPM	Grit	Box Qty
Ceramic				
4-1/2 x 5/8-11				
30202	4-1/2 x 5/8-11	13,300	40	10
30204	4-1/2 x 5/8-11	13,300	60	10
30205	4-1/2 x 5/8-11	13,300	80	10
5 x 5/8-11				
30212	5 x 5/8-11	12,200	40	10
30214	5 x 5/8-11	12,200	60	10
30215	5 x 5/8-11	12,200	80	10
6 x 5/8-11				
30222	6 x 5/8-11	10,200	40	10
30224	6 x 5/8-11	10,200	60	10
30225	6 x 5/8-11	10,200	80	10

UPC	Size	RPM	Grit	Box Qty
Zirconia				
4-1/2 x 5/8-11				
30142	4-1/2 x 5/8-11	13,300	40	10
30144	4-1/2 x 5/8-11	13,300	60	10
30145	4-1/2 x 5/8-11	13,300	80	10
30146	4-1/2 x 5/8-11	13,300	120	10
5 x 5/8-11				
30152	5 x 5/8-11	12,200	40	10
30154	5 x 5/8-11	12,200	60	10
30155	5 x 5/8-11	12,200	80	10
6 x 5/8-11				
30162	6 x 5/8-11	XL 10,000	40	10
30164	6 x 5/8-11	XL 10,000	60	10

Plastic Backing Flap Discs



- Easy Grinding. Simply angle the backing edge against a hard metal to expose more flap material.
- Easier Heavy Duty Jobs. Stiff backing construction paired with a compacted 4 degree flap angle makes grinding easier, quieter and with less vibration.



39722

C3 (Ceramic) for aggressive cutting action. Self-sharpening ceramic grain and cool grinding aid. Ideal for hard-to-grind materials including steel and other heat sensitive materials.

Z3® (Zirconia) for fast, long-lasting grinding. Ideal for heavy-duty applications.

CERAMIC

ZIRCONIA

UPC	Size	RPM	Grit	Box Qty
Ceramic				
4-1/2 x 7/8				
42942	4-1/2 x 7/8	13,300	40	10
42944	4-1/2 x 7/8	13,300	60	10
42945	4-1/2 x 7/8	13,300	80	10
4-1/2 x 5/8-11				
42962	4-1/2 x 5/8-11	13,300	40	10
42964	4-1/2 x 5/8-11	13,300	60	10
42965	4-1/2 x 5/8-11	13,300	80	10
5 x 7/8				
42952	5 x 7/8	12,200	40	10
42954	5 x 7/8	12,200	60	10
42955	5 x 7/8	12,200	80	10

UPC	Size	RPM	Grit	Box Qty
Zirconia				
4-1/2 x 7/8				
39722	4-1/2 x 7/8	13,300	40	10
39724	4-1/2 x 7/8	13,300	60	10
39725	4-1/2 x 7/8	13,300	80	10
39726	4-1/2 x 7/8	13,300	120	10
4-1/2 x 5/8-11				
39712	4-1/2 x 5/8-11	13,300	40	10
39714	4-1/2 x 5/8-11	13,300	60	10
39715	4-1/2 x 5/8-11	13,300	80	10
39716	4-1/2 x 5/8-11	13,300	120	10
5 x 7/8				
39742	5 x 7/8	12,000	40	10
39744	5 x 7/8	12,000	60	10
39745	5 x 7/8	12,000	80	10

Z-Stainless Flap Discs

- Premium blend of Zirconia and Aluminum Oxide grains with grinding aid on a polyester backing.
- Excels on stainless steel applications.
- Grinding aid lubricates the grains for easier break down.
- Designed for heat sensitive applications.



#1 PERFORMER ON STAINLESS



Type 27

Type 29

Regular UPC	XL UPC	Size	Type	Grit	RPM	Box Qty
Type 27						
4-1/2 x 7/8						
31011	31091 XL	4-1/2 x 7/8	T27	36	13,300	10
31012	31092 XL	4-1/2 x 7/8	T27	40	13,300	10
31014	31094 XL	4-1/2 x 7/8	T27	60	13,300	10
31015	31095 XL	4-1/2 x 7/8	T27	80	13,300	10
4-1/2 x 5/8-11						
31171	31231 XL	4-1/2 x 5/8-11	T27	36	13,300	10
31172	31232 XL	4-1/2 x 5/8-11	T27	40	13,300	10
31174	31234 XL	4-1/2 x 5/8-11	T27	60	13,300	10
31175	31235 XL	4-1/2 x 5/8-11	T27	80	13,300	10

Regular UPC	XL UPC	Size	Type	Grit	RPM	Box Qty
Type 29						
4-1/2 x 7/8						
31051	31131 XL	4-1/2 x 7/8	T29	36	13,300	10
31052	31132 XL	4-1/2 x 7/8	T29	40	13,300	10
31054	31134 XL	4-1/2 x 7/8	T29	60	13,300	10
31055	31135 XL	4-1/2 x 7/8	T29	80	13,300	10
4-1/2 x 5/8-11						
31201	31261 XL	4-1/2 x 5/8-11	T29	36	13,300	10
31202	31262 XL	4-1/2 x 5/8-11	T29	40	13,300	10
31204	31264 XL	4-1/2 x 5/8-11	T29	60	13,300	10
31205	31265 XL	4-1/2 x 5/8-11	T29	80	13,300	10

SC Silicon Carbide Flap Discs

- Polyester (40-120), cotton (240-600) backed product has sharp aggressive cutting action for a clean, smooth finish.
- Specialty grinding on granite, marble, stone, plastics, fiberglass, titanium and titanium alloys.



Type 27



UPC	Size	Type	Grit	RPM	Box Qty
4-1/2 x 7/8					
56012	4-1/2 x 7/8	T27	40	13,300	10
56014	4-1/2 x 7/8	T27	60	13,300	10
56015	4-1/2 x 7/8	T27	80	13,300	10
56016	4-1/2 x 7/8	T27	120	13,300	10
56017	4-1/2 x 7/8	T27	240	13,300	10
56018	4-1/2 x 7/8	T27	320	13,300	10
56019	4-1/2 x 7/8	T27	400	13,300	10
56013	4-1/2 x 7/8	T27	600	13,300	10

UPC	Size	Type	Grit	RPM	Box Qty
4-1/2 x 5/8-11					
56022	4-1/2 x 5/8-11	T27	40	13,300	10
56024	4-1/2 x 5/8-11	T27	60	13,300	10
56025	4-1/2 x 5/8-11	T27	80	13,300	10
56026	4-1/2 x 5/8-11	T27	120	13,300	10
56027	4-1/2 x 5/8-11	T27	240	13,300	10
56028	4-1/2 x 5/8-11	T27	320	13,300	10
56029	4-1/2 x 5/8-11	T27	400	13,300	10

A3 Flap Discs

- Premium Aluminum Oxide grain on a polyester backing.
- A3 can be used on ferrous and non ferrous metals as well as plastics and wood.

ALUMINUM OXIDE

USA
MADE

CFE
CONTAMINANT-FREE
Iron, Sulfur, and
Chlorine ≤ 0.1%



39412



Regular UPC	XL UPC	Size	Type	Grit	RPM	Box Qty
Type 27						
4 x 5/8						
39202		4 x 5/8	T27	40	15,300	10
39204		4 x 5/8	T27	60	15,300	10
39205		4 x 5/8	T27	80	15,300	10
4 x 3/8-24						
39212		4 x 3/8-24	T27	40	13,300	10
39214		4 x 3/8-24	T27	60	13,300	10
4-1/2 x 7/8						
39401		4-1/2 x 7/8	T27	36	13,300	10
39402	39442 XL	4-1/2 x 7/8	T27	40	13,300	10
39404	39444 XL	4-1/2 x 7/8	T27	60	13,300	10
39405	39445 XL	4-1/2 x 7/8	T27	80	13,300	10
39407		4-1/2 x 7/8	T27	100	13,300	10
39406	39446 XL	4-1/2 x 7/8	T27	120	13,300	10

Other sizes available as made-to-order.
Contact customer service.

Aluminum

- Unique design for aluminum applications.
- Aluminum Oxide with special treatment of calcium stearate to keep the material cooler and prevent loading with soft materials.

ALUMINUM OXIDE

USA
MADE

CFE
CONTAMINANT-FREE
Iron, Sulfur, and
Chlorine ≤ 0.1%



UPC	Size	Type	Grit	RPM	Box Qty
Type 27					
4-1/2"					
43081	4-1/2 x 7/8	T27	36	13,300	10
43084	4-1/2 x 7/8	T27	60	13,300	10
43091	4-1/2 x 5/8-11	T27	36	13,300	10
43094	4-1/2 x 5/8-11	T27	60	13,300	10
7"					
43241	7 x 7/8	T27	36	8,600	10
43251	7 x 5/8-11	T27	36	8,600	10

UPC	Size	Type	Grit	RPM	Box Qty
Type 29					
4-1/2"					
43101	4-1/2 x 7/8	T29	36	13,300	10
43104	4-1/2 x 7/8	T29	60	13,300	10
43111	4-1/2 x 5/8-11	T29	36	13,300	10
43114	4-1/2 x 5/8-11	T29	60	13,300	10
5"					
43181	5 x 7/8	T29	36	12,200	10
43184	5 x 7/8	T29	60	12,200	10



43081

Z3® 2 – 3" Mini Flap Discs

- Z3® Premium Zirconia alumina grain with a poly/cotton backing.
- Active grinding agent provides cool cutting with only light pressure.
- Mini flap discs are designed to access tight areas and reduce heat build-up.
- Roll-On and Turn-On attachment styles for quick disc changes.
- Type 27 shape for smooth finishes.



Roll-On

ZIRCONIA



Type 27



Turn-On

Roll-On UPC	Use Holder	Size	Type	Grit	RPM	Box Qty
2"						
30001	59732	2"	T27	36	24,000	10
30002	59732	2"	T27	40	24,000	10
30004	59732	2"	T27	60	24,000	10
30005	59732	2"	T27	80	24,000	10
30006	59732	2"	T27	120	24,000	10
3"						
30011	59734	3"	T27	36	24,000	10
30012	59734	3"	T27	40	24,000	10
30014	59734	3"	T27	60	24,000	10
30015	59734	3"	T27	80	24,000	10
30016	59734	3"	T27	120	24,000	10

Turn-On UPC	Use Holder	Size	Type	Grit	RPM	Box Qty
2"						
30022	59738	2"	T27	36	24,000	10
30024	59738	2"	T27	40	24,000	10
30025	59738	2"	T27	60	24,000	10
30026	59738	2"	T27	80	24,000	10
3"						
30032	59735	3"	T27	40	24,000	10
30034	59735	3"	T27	60	24,000	10
30035	59735	3"	T27	80	24,000	10
30036	59735	3"	T27	120	24,000	10

Rubber Holder Pads – 1-1/2 – 4" Roll On / Turn On



Roll-On

Roll On – External Thread

UPC	Specs	Box Qty
59728	1" Dia. x 1/4" / Roll On	1
59730	1-1/2" Dia. x 1/4" / Roll On	1
59732	2" Dia. x 1/4" / Roll On	1
59734	3" Dia. x 1/4" / Roll On	1
59736	4" Dia. x 1/4" / Roll On	1



Turn-On

Turn On – Internal Thread

UPC	Specs	Box Qty
59729	1" Dia. x 1/4" / Turn On	1
59731	1-1/2" Dia. x 1/4" / Turn On	1
59733	2" Dia. x 1/4" / M6	1
59738	2" Dia. x 1/4" / M10	1
59735	3" Dia. x 1/4" / Turn On	1

Z3® Corner Flap Discs

- Premium Zirconia grain with poly-cotton backing provides durability and finish.
- Active grinding aid provides cool cutting with light pressure.
- Specially designed angle for Fillet Welding application.



UPC	Size	Type	Grit	RPM	Box Qty
4-1/2 x 7/8					
42020	4-1/2 x 7/8	T27	36	13,300	10
42021	4-1/2 x 7/8	T27	40	13,300	10
42022	4-1/2 x 7/8	T27	60	13,300	10
42023	4-1/2 x 7/8	T27	80	13,300	10

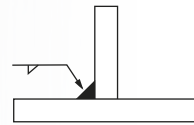

42026



side view

ZIRCONIA

UPC	Size	Type	Grit	RPM	Box Qty
4-1/2 x 5/8-11					
42025	4-1/2 x 5/8-11	T27	36	13,300	10
42026	4-1/2 x 5/8-11	T27	40	13,300	10
42027	4-1/2 x 5/8-11	T27	60	13,300	10
42028	4-1/2 x 5/8-11	T27	80	13,300	10

Z3® Mini Corner Flap Discs

- Premium Zirconia grain with poly-cotton backing provides durability and finish.
- Mini flap discs are designed to access tight areas and reduce heat build-up.
- Active grinding aid provides cool cutting with light pressure.
- Specially designed angle for Fillet Welding application.



UPC	Use Holder*	Size	Type	Grit	RPM	Box Qty
2"						
30060	30089	2"	T27	36	24,000	10
30062	30089	2"	T27	60	24,000	10
30063	30089	2"	T27	80	24,000	10

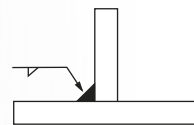

30069



side view

ZIRCONIA

UPC	Use Holder*	Size	Type	Grit	RPM	Box Qty
3"						
30066	30090	3"	T27	36	24,000	10
30068	30090	3"	T27	60	24,000	10
30069	30090	3"	T27	80	24,000	10

* Specially designed back up holders #30089 or #30090 are required to use with Corner Mini Flap Discs as noted above.



Corner Flap Disc

Surface Conditioning Flap Discs

- Premium surface conditioning material for surface preparation.
- Three different grits for blending, deburring, and cleaning.
- For steel and stainless steel.
- **Coarse** discs (brown) are 120 grit,
Medium discs (maroon) are 180 grit,
Very Fine discs (blue) are 320 grit.

Size	RPM		Box Qty	COARSE	MEDIUM	VERY FINE
	Optimal			BROWN	MAROON	BLUE
4-1/2 x 7/8	13,300	2,700 - 5,000	10	70120	70122	70124
4-1/2 x 5/8-11	13,300	2,700 - 5,000	10	70121	70123	70125
5 x 7/8	12,200	2,500 - 4,500	10	70185	70187	70189
5 x 5/8-11	12,200	2,500 - 4,500	10	70186	70188	70190



Medium/Maroon
180 grit

Very Fine/Blue
320 grit

Coarse/Brown
120 grit



Type 29

Interleaf Flap Discs



TOP SIZE ALUMINUM OXIDE

- Stainless steel finishing, light grinding, deburring.
- Alternating flaps of non-woven and coated abrasive materials provide uniform, consistent finishes with very little heat.
- Top size aluminum oxide poly cotton material for cool, yet fast cutting action for long life.
- Three grit levels of discs for a variety of work including stainless steel, aluminum, brass, steel sheet metal.



Size	RPM		Box Qty	COARSE	MEDIUM	VERY FINE
	Optimal			BROWN	MAROON	BLUE
4-1/2 x 7/8	13,300	2,700 - 5,000	10	49686	49687	49688
4-1/2 x 5/8-11	13,300	2,700 - 5,000	10	49689	49690	46691
5 x 7/8	12,200	2,500 - 4,500	10	49692	49693	49694

Grind and finish with one disc – save time and money



COARSE
Brown – 120 grit

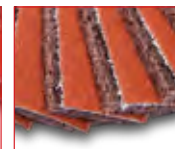

MEDIUM
Maroon – 180 grit
Perfect satin finish,
achieves #4 finish

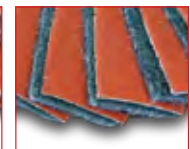

VERY FINE
Blue – 320 grit
High mirror
polish

Felt/Wool Discs – Buffing

For fast mirror finishes

- Stainless steel, aluminum, sheet metal mild steel and brass.
- Flexible felt/wool disc easily works with contoured surfaces for consistent polishing action.
- Cool working action without burning.
- Designed for smooth polishing action, 100% virgin wool.



Type 27

UPC	Size	RPM	Box Qty
49698	4-1/2 x 7/8	13,300	10
49700	4-1/2 x 5/8-11	13,300	10

UPC	Size	RPM	Box Qty
49699	5 x 7/8	12,200	10
49701	5 x 5/8-11	12,200	10



49698

MUST USE WITH BUFFING COMPOUND

Buffing Compound



- Compounds will not discolor metals.
- White SS51 (1,200 grit) compound helps buff aluminum, steel, stainless and natural stone to the desired finish without adding scratches. High gloss finish.
- Green C-3 (2,000 grit) premium buffing compound works on aluminum, steel and stainless steels and eliminates drag lines while still achieving the desired finish and maximum luster.



UPC	Specs	Grit	Color	Box
49652	White SS51	1,200	White	1
49653	Green C-3	2,000	Green	1

Unitized Fiberglass Backed Wheels

- **Very Fine:** Light pressure for fine finishing and polishing; run at slower speeds for fine finish. Very conformable.
- **Medium Fine:** Light pressure for fine finishing and polishing. Conformable with strong edge durability.
- **Hard Medium:** High cut rate with long life for deburring. Very strong edge durability; effective on stainless steel.

ALUMINIUM OXIDE

SILICON CARBIDE

Type 27

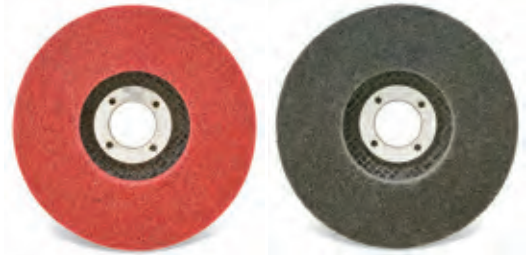
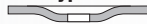

72070

UPC	Size	Density/ Grade	RPM	Box Qty
Aluminium Oxide				
72070	4-1/2 x 7/8	Soft / Very Fine	11,000	10
72071	4-1/2 x 5/8-11	Soft / Very Fine	11,000	10
72072	4-1/2 x 7/8	Medium / Fine	11,000	10
72073	4-1/2 x 5/8-11	Medium / Fine	11,000	10
72074	4-1/2 x 7/8	Hard / Medium	11,000	10
72075	4-1/2 x 5/8-11	Hard / Medium	11,000	10

UPC	Size	Density/ Grade	RPM	Box Qty
Silicon Carbide				
72080	4-1/2 x 7/8	Soft / Very Fine	11,000	10
72082	4-1/2 x 7/8	Medium / Fine	11,000	10
72083	4-1/2 x 5/8-11	Medium / Fine	11,000	10
72084	4-1/2 x 7/8	Hard / Medium	11,000	10
72085	4-1/2 x 5/8-11	Hard / Medium	11,000	10

Premium Unitized Right Angle Grinder Wheels

- Unitized material on a firm, long lasting backing for use on right angle grinders.
- Easily works on large and small areas to clean, blend, surface finish, and polish.
- For metal, plastic and composite materials.

ALUMINIUM OXIDE

SILICON CARBIDE

Type 27



72051

UPC	Size	RPM	Box Qty
2S FINE		Silicon Carbide	
72050	4-1/2 x 7/8	11,000	10
72055	4-1/2 x 5/8-11	11,000	10
72053	5 x 7/8	10,000	10
72058	5 x 5/8-11	10,000	10

UPC	Size	RPM	Box Qty
3S FINE		Silicon Carbide	
72051	4-1/2 x 7/8	11,000	10
72056	4-1/2 x 5/8-11	11,000	10

UPC	Size	RPM	Box Qty
6A MEDIUM		Aluminum Oxide	
72052	4-1/2 x 7/8	11,000	10
72057	4-1/2 x 5/8-11	11,000	10
72054	5 x 7/8	10,000	10
72059	5 x 5/8-11	10,000	10

Surface Preparation Wheels

- Non-woven material impregnated with abrasive grains for blending, finishing and removal of paint and rust.
- Blends and smoothes coated abrasive scratch patterns.



- Easily removes welding or cutting discoloration on stainless steel.
- Compact backing minimizes work piece scratches, allows for full use of disc material and softer/buffing-like finishing.
- Use on steel, aluminum, stainless and nonferrous metals.
- Extremely conformable.

ALUMINIUM OXIDE

SILICON CARBIDE

UPC	Size	Grade	RPM	Box Qty
Aluminum Oxide - Maroon		Type 27		
53241	4 x 5/8	Fine	13,700	10
53242	4-1/2 x 7/8	Fine	13,300	10
53243	4-1/2 x 5/8-11	Fine	13,300	10
53244	7 x 7/8	Fine	8,500	10
53245	7 x 5/8-11	Fine	8,500	10
Aluminum Oxide - Maroon		Roll On		
53251	2" Medium	Medium	25,000	25
53252	3" Medium	Medium	20,000	10

UPC	Size	Grade	RPM	Box Qty
Silicon Carbide - Gray		Type 27		
53246	4 x 5/8	Fine	13,700	10
53247	4-1/2 x 7/8	Fine	13,300	10
53248	4-1/2 x 5/8-11	Fine	13,300	10

UPC	Size	Grade	RPM	Box Qty
Silicon Carbide - Gray		Roll On		
53253	2" Super Fine	Super Fine	25,000	25
53254	3" Super Fine	Super Fine	20,000	10

Type 27



Roll-On





SEMI-FLEX DISCS



Semi-Flex Discs – Red Fiber Backing



- **Silicon Carbide (C)** for aggressive grinding on non-ferrous materials such as: Removing Epoxy, Glue or Urethane, Coatings, Mastiks, Fiberglass (ex: boat hulls), Quartz / Terrazzo / Concrete, Marble, Enamels / Porcelain / Clay.
- **Aluminum Oxide (A)** for metal working and grinding down rough castings. Excellent on materials such as: Cold rolled, Stainless steel, Bronze, Aluminum, Iron.

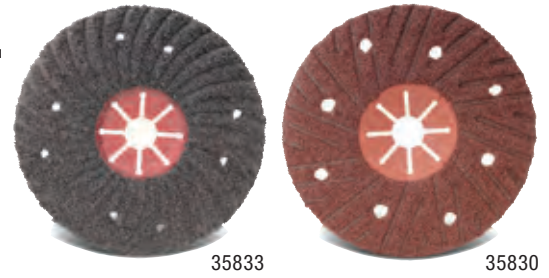

UPC	Size	Type	Grit	RPM	Specs	Box Qty
Aluminum Oxide						
4-1/2 x 7/8 - Domed						
35830	4-1/2 x 7/8	T29	16-B	13,300	A-16-B	25
35831	4-1/2 x 7/8	T29	24-B	13,300	A-24-B	25
35832	4-1/2 x 7/8	T29	36-B	13,300	A-36-B	25
49626	4-1/2 x 7/8	T29	60-B	13,300	A-60-B	25
5 x 7/8 - Domed						
49627	5 x 7/8	T29	16-B	12,250	A-16-B	25
49628	5 x 7/8	T29	24-B	12,250	A-24-B	25
49629	5 x 7/8	T29	36-B	12,250	A-36-B	25
49630	5 x 7/8	T29	50-B	12,250	A-50-B	25
49631	5 x 7/8	T29	60-B	12,250	A-60-B	25
7 x 7/8 - Domed						
35839	7 x 7/8	T29	16-B	8,600	A-16-B	25
35840	7 x 7/8	T29	24-B	8,600	A-24-B	25
35841	7 x 7/8	T29	36-B	8,600	A-36-B	25

UPC	Size	Type	Grit	RPM	Specs	Box Qty
Silicon Carbide						
4-1/2 x 7/8 - Domed						
35833	4-1/2 x 7/8	T29	16-B	13,300	C-16-B	25
35834	4-1/2 x 7/8	T29	24-B	13,300	C-24-B	25
35835	4-1/2 x 7/8	T29	36-B	13,300	C-36-B	25
35836	4-1/2 x 7/8	T29	60-B	13,300	C-60-B	25
35837	4-1/2 x 7/8	T29	80-B	13,300	C-80-B	25
35838	4-1/2 x 7/8	T29	120-B	13,300	C-120-B	25
7 x 7/8 - Domed						
35842	7 x 7/8	T29	16-B	8,600	C-16-B	25
35843	7 x 7/8	T29	24-B	8,600	C-24-B	25
35844	7 x 7/8	T29	36-B	8,600	C-36-B	25
35845	7 x 7/8	T29	60-B	8,600	C-60-B	25

SILICON CARBIDE

ALUMINUM OXIDE

Back-Up Pad Required

Fast Cut Semi-Flex Discs – Red Fiber Backing



SILICON CARBIDE

UPC	Size	Type	Grit	RPM	Specs	Box Qty
4-1/2 x 7/8 - Depressed Center						
36292	4-1/2 x 7/8	T29	16-B	13,300	C-16-B	25
36293	4-1/2 x 7/8	T29	24-B	13,300	C-24-B	25
36294	4-1/2 x 7/8	T29	36-B	13,300	C-36-B	25

UPC	Size	Type	Grit	RPM	Specs	Box Qty
7 x 7/8 - Depressed Center						
36235	7 x 7/8	T29	16-B	8,600	C-16-B	25
36236	7 x 7/8	T29	24-B	8,600	C-24-B	25
36237	7 x 7/8	T29	36-B	8,600	C-36-B	25

Semi-Flex Discs – Rigid Strong, Phenolic Backing

SILICON CARBIDE

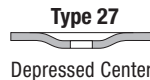

- Rigid phenolic (fiberglass) backing for aggressive grinding applications, stronger than plastic and vulcanized fiber backings.
- Rigid disc design allows for more control when grinding corners and edges.
- No deformation due to use, heat or humidity. Use wet or dry.
No back-up pad needed.



UPC	Size	Type	Grit	RPM	Specs	Box Qty
4-1/2" Diameter - Depressed Center						
49606	4-1/2 x 7/8	T27	16	13,300	C-16-B	25
49608	4-1/2 x 7/8	T27	24	13,300	C-24-B	25
49610	4-1/2 x 7/8	T27	36	13,300	C-36-B	25
49607	4-1/2 x 5/8-11	T27	16	13,300	C-16-B	10
49609	4-1/2 x 5/8-11	T27	24	13,300	C-24-B	10
49611	4-1/2 x 5/8-11	T27	36	13,300	C-36-B	10

UPC	Size	Type	Grit	RPM	Specs	Box Qty
7" Diameter - Depressed Center						
49618	7 x 7/8	T27	16	8,600	C-16-B	25
49620	7 x 7/8	T27	24	8,600	C-24-B	25
49622	7 x 7/8	T27	36	8,600	C-36-B	25



Fiber Discs – Premium Ceramic 2 with Grinding Aid

BEST

- Premium Ceramic grain is extremely hard and self-sharpens during operation. Ceramic grain breaks down with less pressure than Zirconia discs without heat damage.
- Improved grain technology allows for higher stock removal rates and longer product life.
- Advanced grinding aid for cool cutting technology that reduces heat and increases performance.
- Suitable for high pressure grinding applications.



CERAMIC

UPC	Size	RPM	Grit	Box Qty
Premium Ceramic 2				
<i>4-1/2 x 7/8</i>				
59801	4-1/2 x 7/8	13,300	24	25
59802	4-1/2 x 7/8	13,300	36	25
59803	4-1/2 x 7/8	13,300	60	25
59804	4-1/2 x 7/8	13,300	80	25
<i>5 x 7/8</i>				
59805	5 x 7/8	12,200	24	25
59806	5 x 7/8	12,200	36	25
59807	5 x 7/8	12,200	60	25
59808	5 x 7/8	12,200	80	25

UPC	Size	RPM	Grit	Box Qty
<i>7 x 7/8</i>				
59809	7 x 7/8	8,600	24	25
59810	7 x 7/8	8,600	36	25
59811	7 x 7/8	8,600	60	25
59812	7 x 7/8	8,600	80	25

Fiber Discs – Ceramic Blend with Grinding Aid

BEST

- Premium Ceramic grain is extremely hard and self-sharpens during operation.
- Grinding aid keeps the disc cool while grinding hard materials and aluminum.



CERAMIC

UPC	Quick Lock UPC	Size	RPM	Grit	Box Qty
<i>4-1/2 x 7/8</i>					
48181	48881	4-1/2 x 7/8	13,300	24	25
48182	48882	4-1/2 x 7/8	13,300	36	25
48184	48884	4-1/2 x 7/8	13,300	50	25
48185	48885	4-1/2 x 7/8	13,300	60	25
48186	48886	4-1/2 x 7/8	13,300	80	25
<i>5 x 7/8</i>					
48191	48891	5 x 7/8	12,200	24	25
48192	48892	5 x 7/8	12,200	36	25
48194	48894	5 x 7/8	12,200	50	25
48195	48895	5 x 7/8	12,200	60	25
48196	48896	5 x 7/8	12,200	80	25

UPC	Quick Lock UPC	Size	RPM	Grit	Box Qty
<i>7 x 7/8</i>					
48201	48901	7 x 7/8	8,600	24	25
48202	48902	7 x 7/8	8,600	36	25
48204	48904	7 x 7/8	8,600	50	25
48205	48905	7 x 7/8	8,600	60	25
48206	48906	7 x 7/8	8,600	80	25

Fiber Discs, Zirconia – High Performance

BETTER

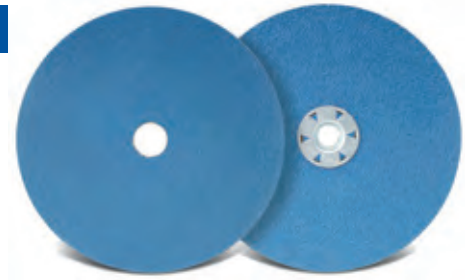

ZIRCONIA

- High concentration of Zirconia and heat-treated Aluminum Oxide grain provides twice the cutting action of premium AO discs and is extremely heat resistant.
- The special fracturing characteristics of the Zirconia grain provide a consistent action throughout the disc's life.
- High performance on blending welds, steel and stainless steel.

UPC	Quick Lock UPC	Size	RPM	Grit	Box Qty
4 x 5/8					
48232		4 x 5/8	15,300	36	25
48234		4 x 5/8	15,300	50	25
4-1/2 x 7/8					
48101	48801	4-1/2 x 7/8	13,300	24	25
48102	48802	4-1/2 x 7/8	13,300	36	25
48104	48804	4-1/2 x 7/8	13,300	50	25
48105	48805	4-1/2 x 7/8	13,300	60	25
48106	48806	4-1/2 x 7/8	13,300	80	25
5 x 7/8					
48111	48811	5 x 7/8	12,200	24	25
48112	48812	5 x 7/8	12,200	36	25
48114	48814	5 x 7/8	12,200	50	25
48115	48815	5 x 7/8	12,200	60	25
48116	48816	5 x 7/8	12,200	80	25

UPC	Quick Lock UPC	Size	RPM	Grit	Box Qty
7 x 7/8					
48121	48821	7 x 7/8	8,600	24	25
48122	48822	7 x 7/8	8,600	36	25
48124	48824	7 x 7/8	8,600	50	25
48125	48825	7 x 7/8	8,600	60	25
48126	48826	7 x 7/8	8,600	80	25
9 x 7/8					
48141	48831	9 x 7/8	6,600	24	25
48142	48832	9 x 7/8	6,600	36	25
48145	48835	9 x 7/8	6,600	60	25
48146	48836	9 x 7/8	6,600	80	25

Fiber Discs – Aluminum Oxide

GOOD



ALUMINUM OXIDE

- Premium quality Aluminum Oxide designed for long life, high stock removal and cool cutting action on steel.
- Sharp, heat-treated Aluminum Oxide grain electrostatically coated to a heavy duty vulcanized Fiber backing.

UPC	Quick Lock UPC#	Size	RPM	Grit	Box Qty
4 x 5/8					
48001		4 x 5/8	15,300	24	25
48002		4 x 5/8	15,300	36	25
48004		4 x 5/8	15,300	50	25
48005		4 x 5/8	15,300	60	25
48006		4 x 5/8	15,300	80	25
48007		4 x 5/8	15,300	100	25
48008		4 x 5/8	15,300	120	25
4-1/2 x 7/8					
48010		4-1/2 x 7/8	13,300	16	25
48011	48711	4-1/2 x 7/8	13,300	24	25
48012	48712	4-1/2 x 7/8	13,300	36	25
48014	48714	4-1/2 x 7/8	13,300	50	25
48015	48715	4-1/2 x 7/8	13,300	60	25
48016	48716	4-1/2 x 7/8	13,300	80	25
48017		4-1/2 x 7/8	13,300	100	25
48018		4-1/2 x 7/8	13,300	120	25
5 x 7/8					
48020		5 x 7/8	12,200	16	25
48021	48721	5 x 7/8	12,200	24	25
48022	48722	5 x 7/8	12,200	36	25
48024	48724	5 x 7/8	12,200	50	25

UPC	Quick Lock UPC#	Size	RPM	Grit	Box Qty
48025	48725	5 x 7/8	12,200	60	25
48026	48726	5 x 7/8	12,200	80	25
48027		5 x 7/8	12,200	100	25
48028		5 x 7/8	12,200	120	25
7 x 7/8					
48030		7 x 7/8	8,600	16	25
48031	48731	7 x 7/8	8,600	24	25
48032	48732	7 x 7/8	8,600	36	25
48034	48734	7 x 7/8	8,600	50	25
48035	48735	7 x 7/8	8,600	60	25
48036	48736	7 x 7/8	8,600	80	25
48037		7 x 7/8	8,600	100	25
48038		7 x 7/8	8,600	120	25
48033		7 x 7/8	8,600	150	25
48039		7 x 7/8	8,600	180	25
9 x 7/8					
48041	48741	9 x 7/8	6,600	24	25
48042	48742	9 x 7/8	6,600	36	25
48044	48744	9 x 7/8	6,600	50	25
48045	48745	9 x 7/8	6,600	60	25
48046	48746	9 x 7/8	6,600	80	25

Fiber Discs Spindles

Zirconia UPC	Aluminum Oxide UPC	Size	Spec	RPM	Spindle Qty
48528	48501	4-1/2 x 7/8	24 Grit	13,300	50
48529	48502	4-1/2 x 7/8	36 Grit	13,300	100
48530	48503	4-1/2 x 7/8	50 Grit	13,300	100
48531	48504	4-1/2 x 7/8	60 Grit	13,300	100
48532	48505	4-1/2 x 7/8	80 Grit	13,300	100
48533	48508	5 x 7/8	24 Grit	12,200	50
48534	48509	5 x 7/8	36 Grit	12,200	100
48535	48510	5 x 7/8	50 Grit	12,200	100
48536	48511	5 x 7/8	60 Grit	12,200	100
48537	48512	5 x 7/8	80 Grit	12,200	100
48538	48515	7 x 7/8	24 Grit	8,600	50

ZIRCONIA

ALUMINUM OXIDE



- Spindle-spool design provides convenient storage and keeps discs flat.

Zirconia UPC	Aluminum Oxide UPC	Size	Spec	RPM	Spindle Qty
48539	48516	7 x 7/8	36 Grit	8,600	100
48540	48517	7 x 7/8	50 Grit	8,600	100
48541	48518	7 x 7/8	60 Grit	8,600	100
48542	48519	7 x 7/8	80 Grit	8,600	100
48251	4-1/2 and 5" Spindle only (for replacement)				

Rubber Fiber Discs Back-up Pads

- Rubber Back-up Pads – Use with coarse grits.
- Spiral ribs provide contact points and form channels for air flow, extending disc life 30% to 50%.
- Larger air holes provide cooler operating area and longer abrasive disc life.
- Flexible Rubber Pads are recommended for contours and Rigid Pads will last longer on aggressive grinding applications.

USA
MADE



UPC	Size	Spec	Box Qty
Rubber with Standard Threaded Spiral Pattern – with Nut			
48220	4-1/2" x 5/8-11	Medium	1
48221	5" x 5/8-11	Medium	1
48222	7" x 5/8-11	Medium	1
48239	9" x 5/8-11	Medium	1
49510	7" x 5/8-11	Flexible	1
49511	7" x 5/8-11	Rigid	1
49527	9" x 5/8-11	Rigid	1
Rubber with Smooth Bore & Spiral Pattern – with Nut			
49515	4"	Medium	1
49521	4-1/2"	Medium	1
49519	5"	Medium	1

UPC	Size	Spec	Box Qty
Rubber with Smooth Face for Low Profile Grinders			
48261	4-1/2"	Medium	1
48262	5"	Medium	1
Rubber with Smooth Face for Fiber Discs with Quick Lock			
48264	5"	Medium	1
48266	7"	Medium	1
Rubber with Smooth Face – with Nut			
49501	4" x 5/8-11	Medium	1
49508	4-1/2" x 5/8-11	Medium	1
49503	5" x 5/8-11	Medium	1
49504	7" x 5/8-11	Flexible	1
49505	7" x 5/8-11	Rigid	1

Polypropylene Fiber Discs Back-up Pads

- Polypropylene Back-up Pads – Use with medium to fine grits.

USA
MADE



UPC	Size	Spec	Box Qty
Standard Spiral Pattern – with Nut			
36204	4-1/2"	Medium	1
36205	5"	Medium	1
36206	7"	Medium	1

UPC	Size	Spec	Box Qty
Smooth Face & Smooth Bore – with Nut			
48218	5" x 5/8-11	Medium	1
48224	7" x 5/8-11	Medium	1
48225	9" x 5/8-11	Medium	1
48226	7" x 5/8-11	Flexible	1
48240	9" x 5/8-11	Flexible	1

QUICK CHANGE DISCS

Grit Comparison Chart

	Grain	Color	Standard	Heavy Duty
Coarse	A/O	Brown	60	50-60
Medium	A/O	Maroon	80-120	60-100
Very Fine	A/O	Blue	180-240	-
Super Fine	S/C	Gray	240-320	-

Surface Conditioning material utilizes a substrate base (nylon fiber), a resin bond (phenolic or polyurethane) and abrasive grain. The fiber and resin are fully waterproof so the product can be used wet or dry. The structure is extremely open so that the product resists loading and runs cool compared to coated abrasives.

2 – 4" Quick Change Discs – Surface Conditioning

- For stainless steel, and ferrous & non-ferrous metals.
- **Premium** – Blending and rust/burr removal.
- **Finish Pro** – Economy choice, high performance design for demanding cleaning, deburring and finishing.
- **Heavy Duty** – Aggressive surface conditioning discs for tough cleaning, deburring and finishing. **2X longer working life than standard discs.**



Size	RPM	Density / Grain / Grade	Roll On PREMIUM UPC	Roll On FINISH PRO UPC	Roll On HEAVY DUTY UPC	Turn On PREMIUM UPC	Turn On FINISH PRO UPC	Box Qty
2"	25,000	Coarse – Brown	59503	59743	59739	59610	59749	50
		Medium – Maroon	59504	59744	59740	59611	59750	
		A Very Fine – Blue	59505	59745		59612	59751	
		S Ultra Fine – Grey	59608					
3"	20,000	Coarse – Brown	59506	59746	59741	59614	59752	25
		Medium – Maroon	59507	59747	59742	59615	59753	
		A Very Fine – Blue	59508	59748		59616	59754	
		S Ultra Fine – Grey	59609					
4"	12,000	Coarse – Brown	59509					25
		Medium – Maroon	59510					
		A Very Fine – Blue	59511					

Rubber Holder Pads – 1-1/2 – 4" Roll On / Turn On



Roll On – External Thread

UPC	Specs	Box Qty
59728	1" Dia. x 1/4" / Roll On	1
59730	1-1/2" Dia. x 1/4" / Roll On	1
59732	2" Dia. x 1/4" / Roll On	1
59734	3" Dia. x 1/4" / Roll On	1
59736	4" Dia. x 1/4" / Roll On	1

Turn On – Internal Thread

UPC	Specs	Box Qty
59729	1" Dia. x 1/4" / Turn On	1
59731	1-1/2" Dia. x 1/4" / Turn On	1
59733	2" Dia. x 1/4" / M6	1
59738	2" Dia. x 1/4" / M10	1
59735	3" Dia. x 1/4" / Turn On	1

Quick Change Discs

1.5" Box Qty: 100

2" Box Qty: 50

3" Box Qty: 25



Roll-On



Turn-On



Die Grinder

BEST

Ceramic Discs

CERAMIC

Grit	RPM 25,000		RPM 25,000		RPM 20,000	
	1.5" Roll On	1.5" Turn On	2" Roll On	2" Turn On	3" Roll On	3" Turn On
24	59900	59940	59910	59950	59920	59960
36	59901	59941	59911	59951	59921	59961
40	59902	59942	59912	59952	59922	59962
50	59903	59943	59913	59953	59923	59963
60	59904	59944	59914	59954	59924	59964
80	59905	59945	59915	59955	59925	59965
100	59906	59946	59916	59956	59926	59966
120	59907	59947	59917	59957	59927	59967

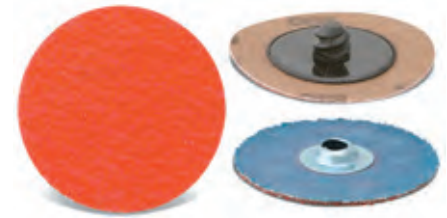

- Self-sharpening Ceramic grain and cool grinding aid for fast, aggressive cutting action on hard-to-grind materials.
- Polyester backing material for long working life.
- Use on steel, stainless and heat sensitive materials.

BETTER

Zirconia w/ Grinding Aid

ZIRCONIA
w/GRINDING AID

Grit	RPM 25,000		RPM 20,000	
	2" Roll On	2" Turn On	3" Roll On	3" Turn On
24	59587	59696	59594	59703
36	59588	59697	59595	59704
40	59589	59698	59596	59705
50	59590	59699	59597	59706
60	59591	59700	59598	59707
80	59592	59701	59599	59708
120	59593	59702	59600	59709

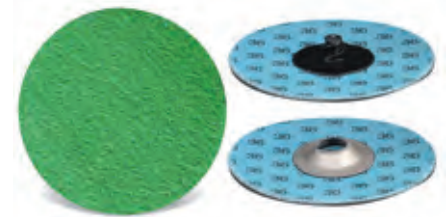

- Zirconia for faster cutting and long working life.
- Strong 2-ply design for flat or contoured work. Grinding aid for cooler cutting.

BETTER

Zirconia

ZIRCONIA

Grit	RPM 25,000		RPM 25,000		RPM 20,000	
	1.5" Roll On	1.5" Turn On	2" Roll On	2" Turn On	3" Roll On	3" Turn On
24	59717	59668	59718	59722	59719	59723
36	59560	59669	59565	59674	59570	59679
40	59561	59670	59566	59675	59571	59680
50	59562	59671	59567	59676	59572	59681
60	59563	59672	59568	59677	59573	59682
80	59564	59673	59569	59678	59574	59683

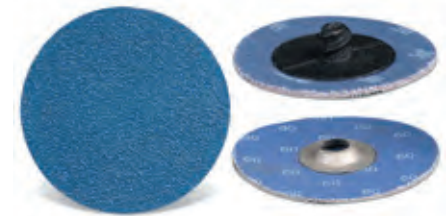

- Zirconia for faster cutting and long working life.
- Strong 2-ply design for flat or contoured work.

GOOD

Aluminum Oxide

ALUMINUM OXIDE

Grit	RPM 25,000		RPM 25,000		RPM 20,000	
	1.5" Roll On	1.5" Turn On	2" Roll On	2" Turn On	3" Roll On	3" Turn On
24	59512	59621	59524	59633	59536	59645
36	59513	59622	59525	59634	59537	59646
40	59514	59623	59526	59635	59538	59647
50	59515	59624	59527	59636	59539	59648
60	59516	59625	59528	59637	59540	59649
80	59517	59626	59529	59638	59541	59650
100	59518	59627	59530	59639	59542	59651
120	59519	59628	59531	59640	59543	59652

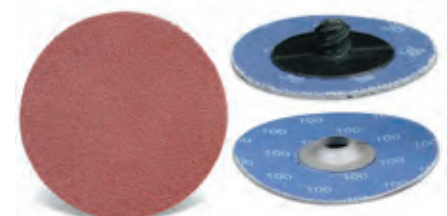

- Aluminum Oxide for long working life.
- Strong 2-ply design for flat or contoured work.

CUTTING WHEELS



Tier	Trade Name	Spec	Grain	Performance	Application
BEST	eXtreme Cut™	CER36-TBF	Ceramic	High Productivity	Metal/Steel
	eXtreme Cut™<i>ss</i>	CER46-TBF			Stainless Steel, Contaminant Free
BETTER	Quickie Cut™	ZA60-TBF, ZA36TBF	Zirconia AO Blend	All Purpose #1 Seller	Metal/Stainless Steel
	SUPER Quickie Cut™	A60-TBF	Premium Treated Aluminum Oxide	Fast Cutting	Metal/Stainless Steel
GOOD	Fast Cut	WA46-RBF	Aluminum Oxide	Good Value	Metal/Stainless Steel
SPECIALTY	Contaminant-Free Cut-Off Wheels	WA60-TBF	White Aluminum Oxide	Application Specific	Stainless Steel, CF Applications
	Aluminum	A46-NBF	Aluminum Oxide	Application Specific	Aluminum, copper, non-ferrous metals
	3-in-1 Cut/Grind/Finish	A36-SBF	Aluminum Oxide	Multi-Purpose, Cost Effective	Metal/Stainless Steel

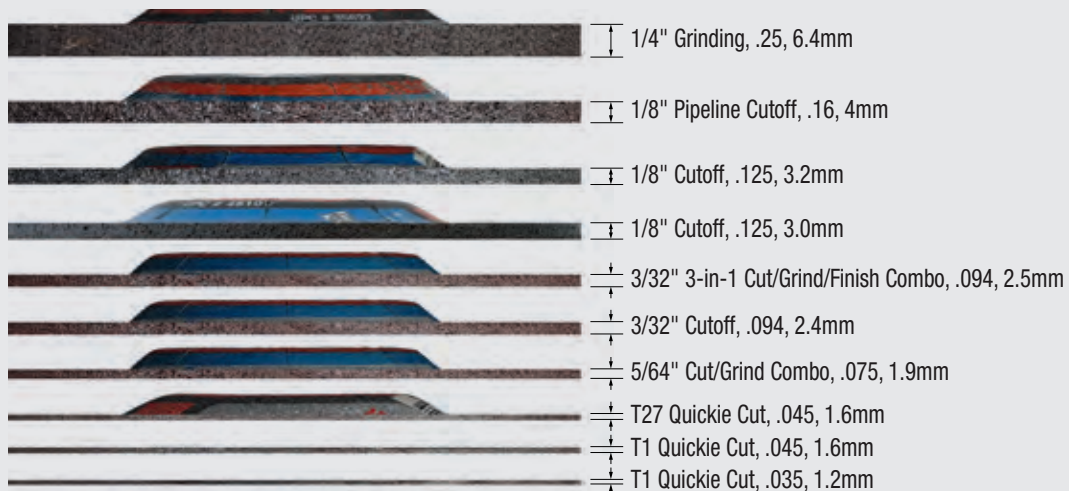

eXtreme Cut™ Ceramic Cutting Wheels

BEST

- Extremely Fast Cutting - high performance sharp CERAMIC grain.
- Advanced bonding system - specially engineered to provide long life and fast cut.
- Labor cost savings – much faster cutting rate compared to conventional cut-off wheels.
- Time cost saving - fewer tool changes due to very long wheel life.
- Can be used on steel and stainless steel.
- Maximum performance on high power machines.



54282

NEW

CERAMIC



Type 1

UPC	Size	Grit	Grain	RPM	Box Qty
Type 1					
4-1/2 x .045					
54280	4-1/2 x .045 x 7/8	36	CER36-TBF	13,300	25
5 x .045					
54281	5 x .045 x 7/8	36	CER36-TBF	12,250	25
6 x .045					
54282	6 x .045 x 7/8	36	CER36-TBF	10,200	25

Type 27

UPC	Size	Grit	Grain	RPM	Box Qty
Type 27					
4-1/2 x .045					
54283	4-1/2 x .045 x 7/8	36	CER36-TBF	13,300	25
54284	4-1/2 x .045 x 5/8-11	36	CER36-TBF	13,300	10
5 x .045					
54285	5 x .045 x 7/8	36	CER36-TBF	12,250	25
54286	5 x .045 x 5/8-11	36	CER36-TBF	12,250	10
6 x .045					
54287	6 x .045 x 7/8	36	CER36-TBF	10,200	25
54288	6 x .045 x 5/8-11	36	CER36-TBF	10,200	10

eXtreme Cut™_{SS} Ceramic Cutting Wheels, Stainless Steel

BEST

- Extremely Fast Cutting - high performance sharp CERAMIC grain excels on Stainless..
- Advanced bonding system - specially engineered to provide long life and fast cut.
- Labor cost savings – much faster cutting rate compared to conventional cut-off wheels.
- Time cost saving - fewer tool changes due to very long wheel life.
- Can be used on stainless steel and steel.
- Maximum performance on high power machines.



54292

NEW

CERAMIC



Type 1

UPC	Size	Grit	Grain	RPM	Box Qty
Type 1					
4-1/2 x .045					
54290	4-1/2 x .045 x 7/8	46	CER46-TBF	13,300	25
5 x .045					
54291	5 x .045 x 7/8	46	CER46-TBF	12,250	25
6 x .045					
54292	6 x .045 x 7/8	46	CER46-TBF	10,200	25

Type 27

UPC	Size	Grit	Grain	RPM	Box Qty
Type 27					
4-1/2 x .045					
54293	4-1/2 x .045 x 7/8	46	CER46-TBF	13,300	25
54294	4-1/2 x .045 x 5/8-11	46	CER46-TBF	13,300	10
5 x .045					
54295	5 x .045 x 7/8	46	CER46-TBF	12,250	25
54296	5 x .045 x 5/8-11	46	CER46-TBF	12,250	10
6 x .045					
54297	6 x .045 x 7/8	46	CER46-TBF	10,200	25
54298	6 x .045 x 5/8-11	46	CER46-TBF	10,200	10

Quickie Cut™ Reinforced Cut-Off Wheels, Type 1

BETTER

- **ZA:** Zirconia and Aluminum Oxide mixture. All purpose wheel. Zirconia grain allows for faster cutting and longer life. Excellent on Steel/Stainless.
- **ZA60-TB-Flex:** Flexible wheel design for fast cutting and easy work penetration.
- **ZA-36-T-Rigid:** Thicker (.045), rigid wheel design for fast cutting and longer life.



STEEL/STAINLESS

ZIRCONIA

Type 1



UPC	Size	Spec	RPM	Box Qty
ZA60-TB-FLEX				
4 x .040				
45014	4 x .040 x 5/8	ZA60-TB-FLEX	15,300	25
4-1/2 x .035				
45010	4-1/2 x .035 x 7/8	ZA60-TB-FLEX	13,300	25
5 x .040				
45011	5 x .040 x 7/8	ZA60-TB-FLEX	12,250	25
6 x .040				
45012	6 x .040 x 7/8	ZA60-TB-FLEX	10,200	25
7 x .045				
45013	7 x .045 x 7/8	ZA60-TB-FLEX	8,500	25

UPC	Size	Spec	RPM	Box Qty
ZA36-T-RIGID				
4-1/2 x .045				
35514	4-1/2 x .045 x 7/8	ZA36-T-BF	13,300	25
5 x .045				
35516	5 x .045 x 7/8	ZA36-T-BF	12,250	25
6 x .045				
35517	6 x .045 x 7/8	ZA36-T-BF	10,200	25
7 x .045				
35518	7 x .045 x 7/8	ZA36-T-BF	8,500	25
9 x .045				
45100	9 x .045 x 7/8	ZA36-T-BF	6,600	25

All 4-1/2" to 6" Quickie Cut wheels are available in Master Packs of 200.

Quickie Cut™ Reinforced Cut-Off Wheels, Type 27

BETTER

- **ZA:** Zirconia and Aluminum Oxide mixture. All purpose wheel. Zirconia grain allows for faster cutting and longer life. Excellent on Steel/Stainless.

ZIRCONIA

Type 27



UPC	Size	Spec	RPM	Box Qty
4 x .045				
45001	4 x .045 x 5/8	ZA60-S	15,300	25
4-1/2 x .045				
45002	4-1/2 x .045 x 7/8	ZA60-S	13,300	25
45141	4-1/2 x .045 x 5/8-11	ZA60-S	13,300	10
5 x .045				
45005	5 x .045 x 7/8	ZA60-S	12,250	25
45142	5 x .045 x 5/8-11	ZA60-S	12,250	10

UPC	Size	Spec	RPM	Box Qty
6 x .045				
45007	6 x .045 x 7/8	ZA60-S	10,200	25
45143	6 x .045 x 5/8-11	ZA60-S	10,200	10
7 x .045				
45008	7 x .045 x 7/8	ZA60-S	8,500	25
45144	7 x .045 x 5/8-11	ZA60-S	8,500	10
9 x .045				
45047	9 x .045 x 7/8	ZA60-S	6,600	25
45145	9 x .045 x 5/8-11	ZA60-S	6,600	10

SUPER *Quickie Cut*™ Reinforced Cut-Off Wheels, Type 1 & 27

BETTER



- Improved bonding technology and innovative grain formula to achieve **40%** more cuts, reduced Burning and Burrs.
- Fast cutting and extended long life (Highest G-Ratio).
- **A60-T**: Maximum cutting speeds with minimal burrs. Provides excellent finish with reduced vibration.
- High performance wheels, maximum cuts with one wheel.
- Maximum cutting speeds with minimal burr and smoother finish.



45102

Type 1

ALUMINUM OXIDE

UPC	Size	RPM	Spec	Box Qty
Type 1 A60-T				
4-1/2 x .045				
45102	4-1/2 x .045 x 7/8	13,300	A60-T	25
5 x .045				
45105	5 x .045 x 7/8	12,250	A60-T	25
6 x .045				
45106	6 x .045 x 7/8	10,200	A60-T	25

Type 27

UPC	Size	RPM	Spec	Box Qty
Type 27 A60-T				
4-1/2 x .045				
45103	4-1/2 x .045 x 7/8	13,300	A60-T	25
45152	4-1/2 x .045 x 5/8-11	13,300	A60-T	10
6 x .045				
45098	6 x .045 x 7/8	10,200	A60-T	25
45153	6 x .045 x 5/8-11	10,200	A60-T	10

Fast Cut Wheels – Metal/Stainless Steel

GOOD

- Quality Aluminum Oxide designed for long life, high stock removal and cool cutting action on steel.
- Fast, smooth cutting action with minimal burr.
- Excellent performance & price! Use on metal and stainless steel.



35131

Type 1

ALUMINUM OXIDE



UPC	Size	Spec	RPM	Box Qty	Master
Type 1 WA46-R					
4-1/2 x .045					
35130	4-1/2 x .045 x 7/8	WA46-R	13,300	25	200
6 x .045					
35131	6 x .045 x 7/8	WA46-R	10,200	25	200

Type 27

UPC	Size	Spec	RPM	Box Qty	Master
Type 27 WA46-R					
4-1/2 x .045					
35132	4-1/2 x .045 x 7/8	WA46-R	13,300	25	200
35133	4-1/2 x .045 x 5/8-11	WA46-R	13,300	10	100
6 x .045					
35134	6 x .045 x 7/8	WA46-R	10,200	25	200
35135	6 x .045 x 5/8-11	WA46-R	10,200	10	100



Contaminant-Free Cut-Off Wheels, Type 1 & 27

- **WA:** White Aluminum Oxide grain for stainless steel.
- Contaminant free wheels contains ≤0.1% iron, sulfur, or chlorine for rust-free and corrosion-free results.
- High quality grain mixture is more friable and cuts freely.



Type 1

UPC	Size	Spec	RPM	Box Qty
WA60-TB-FLEX, Type 1				
36303	4-1/2 x .035 x 7/8	WA60-TB-FLEX	13,300	25
36304	5 x .040 x 7/8	WA60-TB-FLEX	12,250	25
WA36-T-RIGID, Type 1				
35515	4-1/2 x .045 x 7/8	WA36-T-RIGID	13,300	25
36301	5 x .045 x 7/8	WA36-T-RIGID	12,250	25
36302	6 x .045 x 7/8	WA36-T-RIGID	10,200	25
53259	7 x .045 x 7/8	WA36-T-RIGID	8,500	25
53260	9 x .045 x 7/8	WA36-T-RIGID	6,600	25

WHITE AO

Type 27

UPC	Size	Spec	RPM	Box Qty
WA60-R, Type 27				
4-1/2 x .045				
45003	4-1/2 x .045 x 7/8	WA60-R	13,300	25
45154	4-1/2 x .045 x 5/8-11	WA60-R	13,300	10
5 x .045				
45006	5 x .045 x 7/8	WA60-R	12,250	25
45155	5 x .045 x 5/8-11	WA60-R	12,250	10
6 x .045				
45017	6 x .045 x 7/8	WA60-R	10,200	25
45156	6 x .045 x 5/8-11	WA60-R	10,200	10
7 x .045				
45009	7 x .045 x 7/8	WA60-R	8,500	25
45157	7 x .045 x 5/8-11	WA60-R	8,500	10



Aluminum Cut-Off Wheels

- Premium Aluminum Oxide grain and A46-N-grade bond engineered for superior non-loading cutting action.
- Clean steady cuts. Minimal burrs.
- Suitable for aluminum cutting and non-ferrous metals.
- **Applications:** Aluminum, copper and bronze fabrication, sheet and plate work.
- **Industries:** Aerospace, Automotive, Boating, Building & Construction, Naval & Military Plants, Oil & Gas.



Type 1

UPC	Size	Spec	RPM	Box Qty
Type 1 Premium A46-NBF				
53255	4-1/2 x .045 x 7/8	A46-NBF	13,300	25
53256	5 x .045 x 7/8	A46-NBF	12,200	25

Type 27

UPC	Size	Spec	RPM	Box Qty
Type 27 Thin Reinforced A46N-ALU				
4-1/2 x .045				
45004	4-1/2 x .045 x 7/8	A46N-ALU	13,300	25
45146	4-1/2 x .045 x 5/8-11	A46N-ALU	13,300	10
5 x .045				
70114	5 x .045 x 7/8	A46N-ALU	12,250	25
45147	5 x .045 x 5/8-11	A46N-ALU	12,250	10
6 x .045				
70115	6 x .045 x 7/8	A46N-ALU	10,200	25
45148	6 x .045 x 5/8-11	A46N-ALU	10,200	10



3-in-1 Wheels .094 Cut/Grind/Finish – High Performance!

- High performance wheels made to cut quickly, grind easily and finish work surfaces with ONE wheel.
- Contaminant free wheel has ≤0.1% iron, sulfur, or chlorine for rust-free and corrosion-free results.
- Cost effective wheel eliminates frequent wheel changes and increases production times.
- Three layers of fiberglass net reinforcement provides added strength and flexibility.



45218

ALUMINUM OXIDE

Type 27



UPC	Size	Spec	RPM	Box Qty
45218	4-1/2 x .094 (3/32) x 7/8	A36S	13,300	25
45219	4-1/2 x .094 (3/32) x 5/8-11	A36S	13,300	10
45220	5 x .094 (3/32) x 7/8	A36S	12,250	25
45221	5 x .094 (3/32) x 5/8-11	A36S	12,250	10

UPC	Size	Spec	RPM	Box Qty
45222	6 x .094 (3/32) x 7/8	A36S	10,200	25
45223	6 x .094 (3/32) x 5/8-11	A36S	10,200	10
45234	7 x 1/8 (.125) x 7/8	A36S	8,600	25
45235	7 x 1/8 x (.125) x 5/8-11	A36S	8,600	10

Thin Reinforced Cut-Off Wheels

- WA: Aluminum Oxide – Metal & Stainless. 3/32" (.094) thickness for cutting/notching wheels.
- Externally reinforced with a unique bond for long wheel life and faster cutting action.



45020

WHITE AO



Type 1

UPC	Size	Spec	RPM	Box Qty
Type 1				
45028	4-1/2 x 3/32 x 7/8	WA36-S-BF	13,300	25
45030	5 x 3/32 x 7/8	WA36-S-BF	12,250	25
45046	6 x 3/32 x 7/8	WA36-S-BF	10,200	25
45032	7 x 3/32 x 7/8	WA36-S-BF	8,500	25

Type 27

UPC	Size	Spec	RPM	Box Qty
Type 27				
45020	4-1/2 x 3/32 x 7/8	WA36-S-BF	13,300	25
45021	4-1/2 x 3/32 x 5/8-11	WA36-S-BF	13,300	10
45024	6 x 3/32 x 7/8	WA36-S-BF	10,200	25
45025	6 x 3/32 x 5/8-11	WA36-S-BF	10,200	10
45026	7 x 3/32 x 7/8	WA36-S-BF	8,500	25
45027	7 x 3/32 x 5/8-11	WA36-S-BF	8,500	10
45113	9 x 3/32 x 7/8	WA36-S-BF	6,600	25
45114	9 x 3/32 x 5/8-11	WA36-S-BF	6,600	10

Grain Size

Coarse: 8, 10, 12, 14, 16, 20, 24
Med: 30, 36, 46, 54, 60

Grade

Soft: B, D, E, F, G, H
Med: I, J, K, L, M, N, O, P
Hard: Q, R, S, T, U, V, W, X



MAXIMUM
OPERATING
SPEED

4 1/2 x 1/4 x 7/8 A 24R

WIDTH THICKNESS ABRASIVE GRAIN SIZE GRADE

WHEEL SIZE

ABRASIVE

GRAIN SIZE

GRADE

Analysis of Typical Wheel Specifications

C – Ceramic:

Sharp Ceramic grain lasts longer than zirconia for aggressive cutting action on hard-to-grind materials.

ZA – Zirconia Aluminum Oxide:

An improvement over basic Aluminum Oxide grain. Zirconia grain is sharper and easily fractures for faster cutting and longer life.

A – Aluminum Oxide:

The most common of all grains. This grain is used for heavy-duty general purpose work.

WA – White Aluminum Oxide:

The high friability of this grain gives it the characteristic of fast and cool cutting used for light grinding of steels of all kinds, particularly on tool and stainless steel.

C – Silicon Carbide:

Aggressive cutting and grinding of stone, concrete, marble, and other non-metallic materials.

DIE GRINDER CUT-OFF WHEELS



CERAMIC Die Grinder Wheels

BEST

- Premium Ceramic grain with grinding aid designed to provide free cutting and longer life.
- Applications include Steel, Stainless Steel, Aluminum.

UPC	Size	Spec	Material	RPM	Box Qty
36181	3 x 1/32 x 3/8	C60-R-BF	Ceramic	25,000	50
36182	3 x 1/16 x 3/8	C36-R-BF	Ceramic	25,000	50
36183	4 x 1/32 x 3/8	C60-R-BF	Ceramic	19,100	50
36184	4 x 1/16 x 3/8	C36-R-BF	Ceramic	19,100	50



CERAMIC

Type 1

**USA
MADE**



ZIRCONIA Die Grinder Wheels

BETTER

- ZA: Zirconia Aluminum Oxide – Metal, steel and stainless. Longer lasting life and easy cutting action.

UPC	Size	Specs	RPM	Box Qty
1/4" Arbor Hole				
36175	3 x 1/32	ZA60-R-BF	25,000	50
36173	3 x 1/16	ZA36-R-BF	25,000	50
36179	4 x 1/32	ZA60-R-BF	19,100	50
36177	4 x 1/16	ZA36-R-BF	19,100	50
3/8" Arbor Hole				
36176	3 x 1/32	ZA60-R-BF	25,000	50
36174	3 x 1/16	ZA36-R-BF	25,000	50
36180	4 x 1/32	ZA60-R-BF	19,100	50
36178	4 x 1/16	ZA36-R-BF	19,100	50



ZIRCONIA AO

Type 1

**USA
MADE**



ALUMINUM Die Grinder Wheels

- ALU60R specification designed with a non-loading bond specifically for Aluminum.
- Applications include Aluminum, Copper and Bronze fabrication.

UPC	Size	Spec	Material	RPM	Box Qty
36185	3 x 1/16 x 3/8	ALU60-R-BF	Aluminum	25,000	50
36186	4 x 1/16 x 3/8	ALU60-R-BF	Aluminum	19,100	50



ALUMINUM

ALUMINUM OXIDE

Type 1

**USA
MADE**



ALUMINUM OXIDE Die Grinder Wheels

GOOD

- A: Aluminum Oxide for cutting steel.

UPC for Arbor Hole						
Size	Specs	1/4"	3/8"	5/8"	RPM	Box Qty
1-1/2 x 1/32	A60-R-BF	35687	35688		45,000	50
2 x 1/32	A60-R-BF		35689		30,000	50
2 x 1/16	A60-R-BF	45066	35690		30,000	50
2 x 1/8	A24-R-BF		35691		30,000	50
3 x 1/32	A60-R-BF	35500	35501		23,900	50
3 x 1/16	A36-R-BF	35502	35503		23,900	50
3 x 1/16	A60-R-BF	45085	45086		23,900	50
3 x 1/8	A24-R-BF	35504	35505		23,900	25
4 x 1/32	A60-R-BF	35506	35507		22,000	50
4 x 1/16	A36-R-BF	35508	35509		22,000	50
4 x 1/16	A60-R-BF	45088	45087	35510	22,000	50
4 x 1/8	A24-R-BF	35511	35512		22,000	25



**USA
MADE**

ALUMINUM OXIDE

Type 1



Die Grinder Mandrel Adaptor

UPC	Size/Specs	Box Qty
48227	1/4"-3/8" Mandrel Adaptor	1
48245	3/8"-24 Mandrel Adaptor	1





CIRCULAR, STATIONARY, CHOP & GAS SAW WHEELS



7" Circular Saw Wheels

- A: Aluminum Oxide – Metal & Steel
- C: Silicon Carbide – Stone/Concrete

Type 1

UPC	Size	Specs	RPM	Box Qty	Master
59109	7 x 3/32 x 5/8-DIA	A24-R-BF	8,600	25	100
59110	7 x 3/32 x 5/8-DIA	C24-R-BF	8,600	25	100



ALUMINUM OXIDE

SILICON CARBIDE



59109

10 – 20" Stationary Saw Wheels

Stationary saw cut-off wheels cut structural steel, bar stock, tubing and non-ferrous metals.

- A: Aluminum Oxide – Metal & Steel.

Type 1

UPC	Size	Specs	RPM	Box Qty	Master
Stationary Saw Wheels – Premium					
35577	10 x 1/16 x 5/8	A24-R-BF	6,110	10	20
35582	14 x 1/8 x 1	A24-R-BF	4,400	10	20
35584	16 x 5/32 x 1	A24-R-BF	3,820	10	20
35851	20 x 7/32 x 1	A30R-B-BF	3,100	10	20



ALUMINUM OXIDE



35582

UPC	Size	Specs	RPM	Box Qty	Master
Stationary Saw Wheels – Fast Cut					
70111	10 x 1/8 x 5/8	A24-R-BF	6,110	10	20
70105	12 x 1/8 x 1	A24-R-BF	5,100	10	20
70107	18 x 5/32 x 1	A24-R-BF	3,400	10	20
70108	20 x 5/32 x 1	A24-R-BF	3,100	10	20
70109	20 x 3/16 x 1	A24-R-BF	3,100	10	20

- Economical choice for metal, steel and general applications.

10 – 16" Chop Saw Wheels

- **A:** Aluminum Oxide – Metal & Steel. 14" available in **single (SR)** and **double (DR)** fiberglass reinforced.
- **Fast Cut:** Economical choice for metal, steel and general applications.

UPC	Size	Specs	RPM	Box Qty	Master
12-16" All Purpose – Premium					
35575	12 x 3/32 x 1	A36-P-BF DR	5,100	10	20
35576	14 x 3/32 x 1	A36-P-BF DR	4,400	10	20
35670	14 x 3/32 x 1	A30-P-BF SR	4,400	10	20
36133	16 x 3/32 x 1	A36-P-BF DR	3,820	10	20
10-14" General Purpose – Fast Cut					
70110	10 x 3/32 x 5/8	A24-R-BF DR	6,110	10	20
70112	12 x 3/32 x 1	A36-P-BF DR	5,100	10	20
70113	14 x 3/32 x 1	A30-P-BF SR	4,400	10	20
36234	14 x 7/64 x 1	A36-S-BF DR	4,400	10	20



14" Chop Saw Specialty Wheels

- **A:** Aluminum Oxide for steel.
- **WA:** **White Aluminum Oxide** – Excellent on steel & non-ferrous metals.
- **ZA:** **Zirconia Aluminum Oxide** for steel and stainless; High performance cutting, recommended on thicker stock applications such as angle iron, angle bars.



14" Double Reinforced – Angle Iron/Heavy Bars

- Zirconia grain, excellent on all ferrous metal applications, especially thicker stock
- Our #1 performing chop saw cut-off wheel.

UPC	Size	Specs	RPM	Box Qty	Master
14" Double Reinforced – Angle Iron/Heavy Bars					
36125	14 x 3/32 x 1	ZA24-S-BF	4,400	10	20

14" Double Reinforced – MR Stud

- Designed for aluminum drywall stud, aluminum shelving, light gauge steel.

UPC	Size	Specs	RPM	Box Qty	Master
14" Double Reinforced – MR Stud					
36124	14 x 3/32 x 1	A30-R-BF	4,400	10	20

14" Single Reinforced – Stainless

- Designed for stainless steel applications
- Contaminant Free, Fe+S+Cl≤0.1%



UPC	Size	Specs	RPM	Box Qty	Master
14" Single Reinforced – Stainless					
36123	14 x 3/32 x 1	WA36-P-BF	4,400	10	20

14" Double Reinforced – Aluminum

- Aluminum Oxide – Special non-loading formulation for cutting aluminum.

UPC	Size	Specs	RPM	Box Qty	Master
14" Double Reinforced – Aluminum					
36122	14 x 3/32 x 1	A30-N-BF DR	4,400	10	20

12 – 16" High Speed Gas Saws

- **A24R:** Aluminum Oxide – Metal & Steel, Stainless. General purpose. 14" are available in both double and triple reinforced.
- **A24T:** Aluminum Oxide – Metal Decking & Cable. Harder bond for more cuts on thinner metals. 14" are triple reinforced.
- **AC:** (Mix of A/C) – Used on Ductile Iron. 14" are available in both double and triple reinforced.
- **C16:** Silicon Carbide – Asphalt/Green Concrete
- **C24:** Silicon Carbide – Stone/Concrete



35599

Type 1



UPC	Size	Specs	RPM	Box Qty	Master
12 - 16" A24-R, Metal, Steel, Stainless General Purpose					
35587	12 x 5/32 x 20mm	A24-R-BF	6,400	10	20
35589	12 x 5/32 x 1	A24-R-BF	6,400	10	20
36158	14 x 5/32 x 20mm	A24-R-BF	5,500	10	20
36159	14 x 5/32 x 1	A24-R-BF	5,500	10	20
35599	14 x 5/32 x 20mm	A24-R-BF TR	5,500	10	20
35600	14 x 5/32 x 1	A24-R-BF TR	5,500	10	20
36142	16 x 5/32 x 20mm	A24-R-BF TR	4,800	10	20
36143	16 x 5/32 x 1	A24-R-BF TR	4,800	10	20



EB – Electronically Balanced.
All 12-14" wheels are safer, cause less vibration and are more consistent.



Triple reinforced (TR)
to provide extra safety.

UPC	Size	Specs	RPM	Box Qty	Master
12 - 14" A24-T, Metal Decking & Cable, Thinner Metals					
36113	14 x 5/32 x 20mm	A24-T-BF TR	5,500	10	20
36126	14 x 5/32 x 1	A24-T-BF TR	5,500	10	20

UPC	Size	Specs	RPM	Box Qty	Master
12 - 16" AC24-R, Ductile Iron					
35590	12 x 5/32 x 20mm	AC24-R-BF	6,400	10	20
35592	12 x 5/32 x 1	AC24-R-BF	6,400	10	20
36160	14 x 5/32 x 20mm	AC24-R-BF	5,500	10	20
36161	14 x 5/32 x 1	AC24-R-BF	5,500	10	20
35601	14 x 5/32 x 20mm	AC24-R-BF TR	5,500	10	20
35602	14 x 5/32 x 1	AC24-R-BF TR	5,500	10	20
36144	16 x 5/32 x 20mm	AC24-R-BF TR	4,800	10	20

UPC	Size	Specs	RPM	Box Qty	Master
12 - 16" C24-R, Stone/Concrete					
35605	14 x 5/32 x 20mm	C24-R-BF	5,500	10	20
35606	14 x 5/32 x 1	C24-R-BF	5,500	10	20
36116	14 x 5/32 x 20mm	C24-R-BF TR	4,400	10	20
36147	16 x 5/32 x 1	C24-R-BF TR	4,800	10	20

UPC	Size	Specs	RPM	Box Qty	Master
12 - 14" C16-U, Asphalt/Green Concrete					
35603	14 x 5/32 x 20mm	C16-U-BF	5,500	10	20



TR=Triple Reinforced

14 – 16" Rail Track Cut-Off Wheel

- Premium mix of Zirconia and Aluminum Oxide to maximize number of cuts while cutting. quickly and not burning the work piece.

ZIRCONIA

UPC	Size	Size (mm)	Specs	RPM	Box Qty	Master
36162	14 x 1/8 x 1	355 x 3.2 x 25.4	ZA24-R-BF	5,500	10	20
36163	16 x 1/8 x 1	405 x 3.2 x 25.4	ZA24-R-BF	4,800	10	20



36162

Type 1

Demolition Blade

- Metal decking, reinforced concrete, steel, cast iron, ductile iron, PVC pipe and wood.
- Can be used wet or dry.

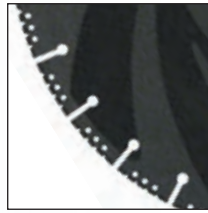

UPC	Size	Specs	RPM	Box Qty
70447	14 x .15 x 1" / 20mm	24 Grit	5,360	1

Type 1



Application Chart

SPEC.	Angle Iron – General Iron / Steel Bar	Metal Decking & Cable Pipe Line Wall Studs	High Tensile Steel	Stainless Steel Sheets	Stainless Steel Bars	Rail Cutting	Cast Steel	Gray Cast Iron	Ductile Iron Pipe & Concrete	Aluminum Alloys	Copper	Brass, Bronze	Titanium
A36P / A302P*	*	*	•	•	•	•	•	•	•				
A30R-Mr Stud			*										
A30N-ALU								•		*	•	•	•
WA36P				*	*	*							
ZA24S	*	*	*	*	*	*	•	•	•				

*A302 is single reinforced (SR). The SR blades have a lower G-ratio but higher cutting rate compared to the double reinforced.

- * = Recommended
- = May Be Used

GRINDING WHEELS



eXtreme Grind™ Grinding Wheels

BEST

- Extremely fast stock removal – high performance **CERAMIC** grain.
- Advanced bonding system – specially engineered to provide longer life and fast grind.
- Dual layer structure:
 - Grinding layer with aggressive coarse ceramic grains
 - Supporting layer for better surface finish and smoother grinding
- High density, uniform grain structure is self-sharpening and provides a cooler cut.
- Labor cost savings – grinds fast and much more efficiently compared to conventional grinding wheels.
- Can be used on steel, stainless steel, and high tensile metals.
- Best choice for heavy material removal applications.
- Maximum performance on high power machines.



54274

54270

CERAMIC



UPC	Size	Grit	Grain	RPM	Box Qty
4-1/2 x 1/4					
54270	4-1/2 x 1/4 x 7/8	24	CER24-TBF	13,300	25
54271	4-1/2 x 1/4 x 5/8-11	24	CER24-TBF	13,300	10
5 x 1/4					
54272	5 x 1/4 x 7/8	24	CER24-TBF	12,250	25
54273	5 x 1/4 x 5/8-11	24	CER24-TBF	12,250	10

STEEL • STAINLESS STEEL

NEW

UPC	Size	Grit	Grain	RPM	Box Qty
6 x 1/4					
54274	6 x 1/4 x 7/8	24	CER24-TBF	10,200	25
54275	6 x 1/4 x 5/8-11	24	CER24-TBF	10,200	10
7 x 1/4					
54276	7 x 1/4 x 7/8	24	CER24-TBF	8,500	25
54277	7 x 1/4 x 5/8-11	24	CER24-TBF	8,500	10

Wheel Profiles



1/4" (.25, 6.4mm) Depressed Center Grinding Wheels, Type 27

BETTER



ULTRA – New and Improved

- Premium wheels made from superior raw materials and advanced technologies for longer working life.
- Ultra Wheels give consistent grinding action for improved performance.

ZA24T: Zirconia Aluminum Oxide Grain

- Zirconia grain is sharper, cuts faster, and lasts longer than aluminum oxide grain.
- T-grade bond for fast cutting and longer life.
- Recommended for steel, cast iron, and stainless steel.



45039

ZIRCONIA

Type 27

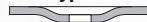

UPC	Size	Spec	RPM	Box Qty
ZA24T - METAL/STAINLESS				
45036	4 x 1/4 x 3/8	ZA24T	15,300	10
35611	4 x 1/4 x 5/8	ZA24T	15,300	10
35624	4-1/2 x 1/4 x 7/8	ZA24T	13,300	25
35625	4-1/2 x 1/4 x 5/8-11	ZA24T	13,300	10
37535	5 x 1/4 x 7/8	ZA24T	12,250	25
37530	5 x 1/4 x 5/8-11	ZA24T	12,250	10
45039	6 x 1/4 x 7/8	ZA24T	10,200	25
45040	6 x 1/4 x 5/8-11	ZA24T	10,200	10
35644	7 x 1/4 x 7/8	ZA24T	8,600	25
35645	7 x 1/4 x 5/8-11	ZA24T	8,600	10
35658	9 x 1/4 x 7/8	ZA24T	6,600	25
35659	9 x 1/4 x 5/8-11	ZA24T	6,600	10

#1 Selling Grinding Wheel

A24R: Aluminum Oxide Grain

- #1 selling 1/4" Depressed Center Grinding Wheel.
- R-grade bond for longer life and excellent stock removal.



35620

WA24S: White Aluminum Oxide Grain – Stainless Steel

- Contaminant-Free design for fast cutting of stainless steel, ferrous metals.
- Contains ≤0.1% iron, sulfur, or chlorine for rust-free and corrosion-free results.



WHITE AO

UPC	Size	Spec	RPM	Box Qty
WA24S - STAINLESS/METAL				
35673	4-1/2 x 1/4 x 7/8	WA24S	13,300	25
35674	4-1/2 x 1/4 x 5/8-11	WA24S	13,300	10
37543	5 x 1/4 x 7/8	WA24S	12,250	25
37531	5 x 1/4 x 5/8-11	WA24S	12,250	10
45048	6 x 1/4 x 7/8	WA24S	10,200	25
45049	6 x 1/4 x 5/8-11	WA24S	10,200	10
35677	7 x 1/4 x 7/8	WA24S	8,600	25
35678	7 x 1/4 x 5/8-11	WA24S	8,600	10
45081	9 x 1/4 x 7/8	WA24S	6,600	25
45082	9 x 1/4 x 5/8-11	WA24S	6,600	10

ALUMINUM OXIDE

UPC	Size	Spec	RPM	Box Qty
A24R - METAL				
35620	4-1/2 x 1/4 x 7/8	A24R	13,300	25
35621	4-1/2 x 1/4 x 5/8-11	A24R	13,300	10
35626	5 x 1/4 x 7/8	A24R	12,250	25
35628	5 x 1/4 x 5/8-11	A24R	12,250	10
35632	6 x 1/4 x 7/8	A24R	10,200	25
35633	6 x 1/4 x 5/8-11	A24R	10,200	10
35640	7 x 1/4 x 7/8	A24R	8,600	25
35641	7 x 1/4 x 5/8-11	A24R	8,600	10
35654	9 x 1/4 x 7/8	A24R	6,600	25
35655	9 x 1/4 x 5/8-11	A24R	6,600	10

Fast Cut 1/4" (.25) Depressed Center Grinding Wheels, Type 27 & 28

GOOD

ALUMINUM OXIDE



A24N Fast Cut: Aluminum Oxide Grain

- Soft N-grade bond for fast stock removal.
- Excellent ratio of stock removal/wheel loss.



UPC	Size	Spec	Type	RPM	Box Qty
Type 27, FAST CUT A24N					
35699	4 x 1/4 x 5/8	A24N	T27	15,300	25
35622	4-1/2 x 1/4 x 7/8	A24N	T27	13,300	25
35623	4-1/2 x 1/4 x 5/8-11	A24N	T27	13,300	10
35627	5 x 1/4 x 7/8	A24N	T27	12,250	25
35629	5 x 1/4 x 5/8-11	A24N	T27	12,250	10
36231	6 x 1/4 x 7/8	A24N	T27	10,200	25
36232	6 x 1/4 x 5/8-11	A24N	T27	10,200	10
35642	7 x 1/4 x 7/8	A24N	T27	8,600	25
35643	7 x 1/4 x 5/8-11	A24N	T27	8,600	10
35656	9 x 1/4 x 7/8	A24N	T27	6,600	25
35657	9 x 1/4 x 5/8-11	A24N	T27	6,600	10

Hub Adapter Kit

UPC	Size/Specs	Box Qty
48228	CP-50 Adapter Kit	10

A24R Fast Cut: Aluminum Oxide Grain

- R-grade bond for excellent life and stock removal.



UPC	Size	Spec	Type	RPM	Box Qty
Type 27, FAST CUT A24R - METAL					
36255	4-1/2 x 1/4 x 7/8	A24N	T27	13,300	25
36256	4-1/2 x 1/4 x 5/8-11	A24N	T27	13,300	10
36259	6 x 1/4 x 7/8	A24N	T27	10,200	25
36260	6 x 1/4 x 5/8-11	A24N	T27	10,200	10
36261	7 x 1/4 x 7/8	A24N	T27	8,600	25
36262	7 x 1/4 x 5/8-11	A24N	T27	8,600	10



UPC	Size	Spec	Type	RPM	Box Qty
Type 28, FAST CUT A24R - METAL					
35646	7 x 1/4 x 7/8	A24R	T28	8,600	25
35647	7 x 1/4 x 5/8-11	A24R	T28	8,600	10
35660	9 x 1/4 x 7/8	A24R	T28	6,600	25
35661	9 x 1/4 x 5/8-11	A24R	T28	6,600	10

Aluminum Depressed Center Wheels, Type 27

Premium AO Grain – Aluminum A30N

- 1/4" (.25 Thick) Type 27 grinding wheels for aluminum guaranteed to outperform competitor wheels.
- Soft N-grade bond for weld removal.
- Recommended for aluminum, copper, zinc, and other non-ferrous materials.



UPC	Size	RPM	Box Qty
Premium AO Grain – Aluminum A30N			
4 x 1/4			
36107	4-1/2 x 1/4 x 7/8	13,300	25
36108	4-1/2 x 1/4 x 5/8-11	13,300	10

ALUMINUM

ALUMINUM OXIDE



UPC	Size	RPM	Box Qty
5 x 1/4			
36109	5 x 1/4 x 7/8	12,200	25
36110	5 x 1/4 x 5/8-11	12,200	10
9 x 1/4			
36156	9 x 1/4 x 7/8	6,600	25
36157	9 x 1/4 x 5/8-11	6,600	10

1/8" (.125) Depressed Center Grinding Wheels, Type 27

- ULTRA:**
- Premium wheels made from superior raw materials and advanced technologies for longer working life.
 - Ultra Wheels give consistent cutting action for faster and easier performance.



ZA24T: Zirconia Aluminum Oxide grain mixture with T-grade bond. High performance design for fast cutting and longer life. Excellent cutting of ferrous metals and stainless steels.

A24R: Aluminum Oxide grain. R-grade bond for fast cutting and long life. Works well on steel, cast iron, and welds.

ZIRCONIA

BEST

UPC	Size	Spec	RPM	Box Qty
ZA24T - STEEL/STAINLESS - ULTRA				
45212	6 x 1/8 x 7/8	ZA24T	10,200	25
45213	6 x 1/8 x 5/8-11	ZA24T	10,200	10
45214	7 x 1/8 x 7/8	ZA24T	8,600	25
45215	7 x 1/8 x 5/8-11	ZA24T	8,600	10

ALUMINUM OXIDE

BETTER

UPC	Size	Spec	RPM	Box Qty
A24R - STEEL - ULTRA				
35612	4-1/2 x 1/8 x 7/8	A24R	13,300	25
35613	4-1/2 x 1/8 x 5/8-11	A24R	13,300	10
35675	5 x 1/8 x 7/8	A24R	12,250	25
35676	5 x 1/8 x 5/8-11	A24R	12,250	10
35630	6 x 1/8 x 7/8	A24R	10,200	25
35631	6 x 1/8 x 5/8-11	A24R	10,200	10
35634	7 x 1/8 x 7/8	A24R	8,600	25
35635	7 x 1/8 x 5/8-11	A24R	8,600	10
35648	9 x 1/8 x 7/8	A24R	6,650	25
35649	9 x 1/8 x 5/8-11	A24R	6,650	10



WA24S: White Aluminum Oxide grain with S-grade bond. Contaminant Free wheel for fast cutting of stainless steel, ferrous metals. Contains ≤0.1% iron, sulfur, or chlorine for rust-free and corrosion-free results.

WHITE AO

UPC	Size	Spec	RPM	Box Qty
WA24S - STAINLESS/METAL - ULTRA				
35616	4-1/2 x 1/8 x 7/8	WA24S	13,300	25
35617	4-1/2 x 1/8 x 5/8-11	WA24S	13,300	10
36189	6 x 1/8 x 7/8	WA24S	10,200	25
36190	6 x 1/8 x 5/8-11	WA24S	10,200	10

Fast Cut A24Q: Aluminum Oxide grain. Q-grade bond for fast cutting.

GOOD

UPC	Size	Spec	RPM	Box Qty
A24Q - METAL - FAST CUT				
36219	4-1/2 x 1/8 x 7/8	A24Q	13,300	25
36220	4-1/2 x 1/8 x 5/8-11	A24Q	13,300	10
36223	6 x 1/8 x 7/8	A24Q	10,200	25
36224	6 x 1/8 x 5/8-11	A24Q	10,200	10

1/8" Wheel Profile



Pipeline 1/8" (.160) Depressed Center Grinding Wheels, Type 27

Pipeline wheels are engineered for light or root pass grinding and cutting.

- ULTRA:**
- Premium wheels made from superior raw materials and advanced technologies for longer working life.
 - Ultra Wheels give consistent cutting action for faster and easier performance.



45204

ZA24T: Zirconia Aluminum Oxide grain mixture with T-grade bond. High performance design for fast cutting and longer life. Excellent cutting of ferrous metals and stainless steels.

A24T: Aluminum Oxide grain with T-grade bond for fast cutting of steel.

ZIRCONIA		BEST			
UPC	Size	Spec	RPM	Box Qty	
ZA24T METAL/STAINLESS – ULTRA					
35667	4-1/2 x 1/8 x 7/8	ZA24T	13,300	25	
35665	4-1/2 x 1/8 x 5/8-11	ZA24T	13,300	10	
45203	6 x 1/8 x 7/8	ZA24T	10,200	25	
45202	6 x 1/8 x 5/8-11	ZA24T	10,200	10	
35681	7 x 1/8 x 7/8	ZA24T	8,600	25	
35682	7 x 1/8 x 5/8-11	ZA24T	8,600	10	

ALUMINUM OXIDE		Type 27				BETTER	
UPC	Size	Spec	RPM	Box Qty			
A24T METAL – ULTRA							
35666	4-1/2 x 1/8 x 7/8	ZA24T	13,300	25			
35664	4-1/2 x 1/8 x 5/8-11	ZA24T	13,300	10			
45200	5 x 1/8 x 7/8	ZA24T	12,250	25			
45201	5 x 1/8 x 5/8-11	ZA24T	12,250	10			
45206	6 x 1/8 x 7/8	ZA24T	10,200	25			
45207	6 x 1/8 x 5/8-11	ZA24T	10,200	10			
35679	7 x 1/8 x 7/8	ZA24T	8,600	25			
35680	7 x 1/8 x 5/8-11	ZA24T	8,600	10			

Fast Cut A24T: Aluminum Oxide T-bond for fast cutting.

ALUMINUM OXIDE		GOOD			
UPC	Size	Spec	RPM	Box Qty	
A24T METAL – FAST CUT					
59100	4-1/2 x 1/8 x 7/8	A24T	13,300	25	
59101	4-1/2 x 1/8 x 5/8-11	A24T	13,300	10	
36246	6 x 1/8 x 7/8	A24T	10,200	25	
36247	6 x 1/8 x 5/8-11	A24T	10,200	10	
36248	9 x 1/8 x 7/8	A24T	6,650	25	
36249	9 x 1/8 x 5/8-11	A24T	6,650	10	



59100



Application Chart – 1/8" Cutting/Notching and 1/8" Pipeline

SPEC.	Angle Iron – General Iron / Steel Bar	Metal Decking & Cable Pipe Line	Wall Studs High Tensile Steel	Stainless Steel Sheets Stainless Steel Bars	Rail Cutting Cast Steel	Grey Cast Iron Ductile Iron Pipe & Concrete	Aluminum Alloys Copper	Brass, Bronze Titanium	Asphalt / Green Concrete Concrete	Roof – Tiles Slate	Masonry Marble	Paving Bricks Firing Bricks	Solid Bricks Clay Pipe
A24R	*	*	•	•	*	*							
A24T	*	*	*	*	*	*	•	•	•				
C24R						•	*	*	*	•	*	*	*
WA24S	•	•	•	•	*								
ZA24T	*	*	*	*	*	*							

* = Recommended
 • = May Be Used

FERROUS METALS **CASTINGS** **NON-FERROUS METALS** **MASONRY**

C3 Green Wheels

- High concentration of ceramic grain provides for very fast grinding and long life.
- Contains less than 0.1% of iron, sulfur & chlorine.
- Use on: stainless steel, steel, hard face, titanium, inconel, **aluminum**.

CERAMIC



Type 27



1/8" / 3.2mm / .125

BEST

UPC	Size	Specs	RPM	Box Qty
49750	4-1/2 x 1/8 (3.2mm) x 7/8	ASL-36P-BF	13,300	25
49751	4-1/2 x 1/8 (3.2mm) x 5/8-11	ASL-36P-BF	13,300	10

Green Grind Grinding Wheels, Type 27

- Zirconia Premium grain allows for high performance grinding action.
- Faster metal removal than aluminum oxide wheels.
- Ideal for tank fabrication, power plant maintenance and metal fabrication.
- Contains less than 0.1% of iron, sulfur & chlorine.
- Grain and bond engineered for cooler working. Does not discolor or warp stainless steel.
- Made for smoother, quieter working and less operator fatigue.
- Use on: stainless steel, steel, hard face, titanium, inconel, **aluminum**.

ZIRCONIA

BETTER



Type 27

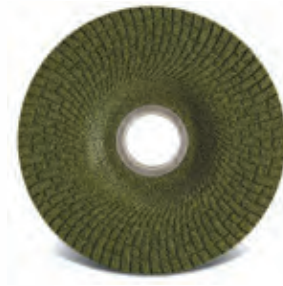

5/32" / 4mm / .16

UPC	Size	Grit	RPM	Box Qty
4-1/2 x 5/32				
49543	4-1/2 x 5/32 (4mm) x 7/8	36	13,300	25
49544	4-1/2 x 5/32 (4mm) x 5/8-11	36	13,300	10
5 x 5/32				
49545	5 x 5/32 (4mm) x 7/8	36	12,250	25
49546	5 x 5/32 (4mm) x 5/8-11	36	12,250	10

UPC	Size	Grit	RPM	Box Qty
7 x 5/32				
49547	7 x 5/32 (4mm) x 7/8	36	8,500	25
49548	7 x 5/32 (4mm) x 5/8-11	36	8,500	10
4-1/2 x 1/4				
49752	4-1/2 x 1/4 (6.4mm) x 7/8	36	13,300	10
49753	4-1/2 x 1/4 (6.4mm) x 5/8-11	36	13,300	10

Mini Depressed Center Grinding Wheels

- Automotive parts manufacturing, sheet metal production, finishing work, weld spot cleaning, ornamental iron work, rough die cast cleaning & detailing, light to heavy stock removal.
- Compact and lightweight for easy use in hard to reach work areas.
- Advanced abrasive grain blend for smooth grinding.
- Designed to last longer than traditional sanding discs and some carbide burs in the market.
- Fiberglass reinforced for overall safety.

ALUMINUM OXIDE



49684

Type 27

UPC	Size	Specs	RPM	Box Qty
49682	2-5/16 x 5/32 x 3/8	A40	20,000	25
49683	2-5/16 x 5/32 x 3/8	A60	20,000	25
49684	2-5/16 x 5/32 x 3/8	A80	20,000	25



SANDING DISCS & SHEETS



Take the Tear Test!



USA
MADE

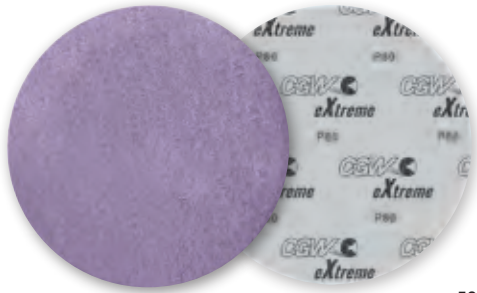

52296



CERAMIC

eXtreme Paper Sanding Discs

BEST

Ceramic, C-Weight Latex Paper Backing, Open Coat

- Premium sharp ceramic grain for best sanding results.
- Consistent finish with 2X life over conventional discs.
- Anti-clogging with stearate coating resists loading.
- Maximum performance relative to cost.

NEW

UPC	Size	Style	Grain	Box Qty	Master Box
Hook & Loop (No Hole)					
5"					
52275	5"	Hook & Loop	P80	100	800
52276	5"	Hook & Loop	P100	100	800
52277	5"	Hook & Loop	P120	100	800
52278	5"	Hook & Loop	P150	100	800
52279	5"	Hook & Loop	P180	100	800
52280	5"	Hook & Loop	P220	100	800
52281	5"	Hook & Loop	P320	100	800
6"					
52282	6"	Hook & Loop	P80	100	800
52283	6"	Hook & Loop	P100	100	800
52284	6"	Hook & Loop	P120	100	800
52285	6"	Hook & Loop	P150	100	800
52286	6"	Hook & Loop	P180	100	800
52287	6"	Hook & Loop	P220	100	800
52288	6"	Hook & Loop	P320	100	800

UPC	Size	Style	Grain	Box Qty	Master Box
PSA DOR (Disc On Roll)					
5"					
52289	5"	PSA DOR	P80	100	800
52290	5"	PSA DOR	P100	100	800
52291	5"	PSA DOR	P120	100	800
52292	5"	PSA DOR	P150	100	800
52293	5"	PSA DOR	P180	100	800
52294	5"	PSA DOR	P220	100	800
52295	5"	PSA DOR	P320	100	800
6"					
52296	6"	PSA DOR	P80	100	800
52297	6"	PSA DOR	P100	100	800
52298	6"	PSA DOR	P120	100	800
52299	6"	PSA DOR	P150	100	800
52300	6"	PSA DOR	P180	100	800
52301	6"	PSA DOR	P220	100	800
52302	6"	PSA DOR	P320	100	800

DWT and VAC hole available as made-to-order.

SANDING DISCS

eXtreme



Paper Sanding Discs

**USA
MADE**



DOR = Disc on Roll
DWT = Disc with Tab

Vacuum disc available as DWT only



Gold with Mylar Paper Disc

BETTER

Aluminum Oxide, C-Weight Paper/Film Backing, Open Coat

- Made with a strong .0005 Mylar film for superior edge tear resistance, outperforms other C-Weight gold discs.
- Stearated paper with heat treated aluminum oxide grain and a full phenolic bond system provides uniform scratch pattern.
- Open coat disc delivers fast cut and exceptionally long life.



DWT

ALUMINUM OXIDE

5" Gold with Mylar DWT & DOR PSA

Grit	DOR	DWT	5VAC	8VAC	Size	Box Qty	Master Box
P40		49790			5"	50	400
P60	49761	49791			5"	50	400
P80	49762	49792	49822	49852	5"	100	800
P100	49763	49793	49823	49853	5"	100	800
P120	49764	49794	49824	49854	5"	100	800
P150	49765	49795	49825	49855	5"	100	800
P180	49766	49796	49826	49856	5"	100	800
P220	49767	49797	49827		5"	100	800
P240		49798			5"	100	800
P320		49800			5"	100	800
P400		49801			5"	100	800
P600		49803			5"	100	800
P800		50965			5"	100	800

5" Gold with Mylar Hook & Loop

Grit	No VAC	5VAC	8VAC	Size	Box Qty	Master Box
P40	49925		49985	5"	50	400
P60	49926	49956	49986	5"	50	400
P80	49927	49957	49987	5"	100	800
P100	49928	49958	49988	5"	100	800
P120	49929	49959	49989	5"	100	800
P150	49930	49960	49990	5"	100	800
P180	49931	49961	49991	5"	100	800
P220	49932	49962	49992	5"	100	800
P320	49935		49995	5"	100	800
P400	49936			5"	100	800
P600	49938			5"	100	800
P1000	52166			5"	100	800

6" Gold with Mylar DWT & DOR PSA

Grit	DOR	DWT	Size	Box Qty	Master Box
P40		49805	6"	50	400
P60	49776	49806	6"	50	400
P80	49777	49807	6"	100	800
P100	49778	49808	6"	100	800
P120	49779	49809	6"	100	800
P150	49780	49810	6"	100	800
P180	49781	49811	6"	100	800
P220	49782	49812	6"	100	800
P240		49813	6"	100	800
P320		49815	6"	100	800
P400		49816	6"	100	800
P600		49818	6"	100	800

6" Gold with Mylar Hook & Loop

Grit	6VAC	Size	Box Qty	Master Box
P40	49970	6"	50	400
P60	49971	6"	50	400
P80	49972	6"	100	800
P100	49973	6"	100	800
P120	49974	6"	100	800
P150	49975	6"	100	800
P180	49976	6"	100	800
P220	49977	6"	100	800

Other sizes available as made-to-order.
Contact customer service.

Film Sanding Discs

BETTER

USA
MADE



Q711T Film Disc

Aluminum Oxide, 3 Mill Film Back, Open Coat

- Film is the best choice for dry and wet sanding applications.
- Film backing – fast, consistent finish, longer life. Strong, yet pliable .003 Mylar backing.
- Film offers up to 4X the life vs. paper discs.



Q711T DOR



Q711T DWT

ALUMINUM OXIDE

5" Q711T DWT & DOR PSA

Grit	DOR	DWT	Box Qty	Master Box
P80	51015	51051	100	800
P100	51016	51052	100	800
P120	51017	51053	100	800
P150	51018	51054	100	800
P180	51019	51055	100	800
P220	51020	51056	100	800
P240		51057	100	800
P280		51058	100	800
P320		51059	100	800
P400		51060	100	800
P600		51062	100	800
P800		51063	100	800
P1000		51064	100	800
P1200		51065	100	800
P2000		51066	100	800

6" Q711T DWT PSA

Grit	DWT	Box Qty	Master Box
P80	51069	100	800
P100	51070	100	800
P120	51071	100	800
P150	51072	100	800
P180	51073	100	800
P220	51074	100	800

5" Q711T Hook & Loop

Grit	No VAC	5VAC	8VAC	Box Qty	Master Box
P80	51231	51267	51303	100	800
P100	51232		51304	100	800
P120	51233	51269	51305	100	800
P150	51234	51270	51306	100	800
P180	51235		51307	100	800
P220	51236	51272	51308	100	800
P320	51239			100	800
P400	51240			100	800
P600	51242			100	800

DOR = Disc on Roll
DWT = Disc with Tab

Other sizes available as made-to-order.
Contact customer service.

6" Q711T No VAC Hook & Loop

Grit	No VAC	Box Qty	Master Box
P80	51249	100	800
P100	51250	100	800
P120	51251	100	800
P180	51253	100	800
P220	51254	100	800

Cloth Sanding Discs



J-Weight Cloth PSA Discs

Aluminum Oxide, J-Weight, Open Coat

- Flexible J-Weight polyester/cotton cloth is an outstanding product for the right applications and is worth the higher cost of cloth disc compared to paper.
- Applications: wood sanding, mold sanding, contour sanding, breaking edges.

Grit	DWT	Size	Box Qty	Master Box
P60	51657	5"	50	400
P80	51658	5"	50	400
P100	51659	5"	100	800
P120	51660	5"	100	800



DWT

GOOD

ALUMINUM OXIDE

Grit	DWT	Size	Box Qty	Master Box
P150	51661	5"	100	800
P180	51662	5"	100	800
P220	51663	5"	100	800

Premium AO X-Weight Resin Cloth PSA Discs

- Tough and durable X-Weight resin bond cloth disc for general purpose work.

Size/Grit	36	40	50	60	80	100	120	180	Box Qty
2"					53327				100
3"				53335	53336	53337	53338		100
5"	52636	52637	52638	52639	52640	52641	52642	52644	50
6"	52647	52648		52650	52651		52653		50
8"	52658			52661	52662				50
12"	52680	52681	52682	52683	52684	52685	52686		25

ALUMINUM OXIDE

GOOD



52639

Premium ZA Y-Weight Resin Cloth PSA Discs

- Y-Weight resin bond polyester cloth disc with active filler for fast cutting action.
- Very cool cutting action and long disc life. Applications: Stainless steel, steel & aluminum.

Size/Grit	36	40	50	60	80	100	120	Box Qty
5"	52714		52716	52717	52718		52720	50
6"					52726			50
12"	52746	52747	52748	52749	52750			25
20"	52762							25

ZIRCONIA AO

BETTER



52717

Premium ZA Y-Weight Resin Cloth PSA Discs – Zirc W/Grinding Aid

- Y-Weight resin bond polyester cloth disc with two coatings of grinding aid. Applications: Cast iron, nickel, stainless steel.

Size/Grit	36	40	50	60	80	100	120	Box Qty
5"			52773	52774	52775			50
16"	52811			52814	52815			25
20"	52819	52820		52822	52823			25

**ZIRCONIA
w/GRINDING AID**

BEST



52773

Other sizes available as made-to-order.
Contact customer service.

7000 Series Fiberglass Hubbed Disc Pads



Disc Pad Selection Information

- **Firm Pads** – designed for use on flat surfaces & with grits 100 and coarser.
- **Medium Pads** – designed for use on both flat & curved surfaces with grits 120 – finer.

Fiberglass Hubbed PSA Disc Pads

- **Molded urethane body:**
 - Hub, foam & facing are all one molded unit.
 - More durable and longer lasting than bonded pads.
- Durable vinyl face for production sanding.
- Strong hub for heat resistance.
- **To use with Orbital Sander only.**

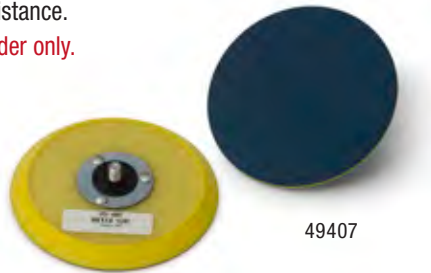

Fiberglass Hubbed Hook & Loop Disc Pads

- **Molded urethane body:**
 - Hub, foam & facing are all one molded unit.
 - More durable and longer lasting than bonded pads.
- "J" hook face for strong hook & loop attachment for production sanding.
- Strong hub for heat resistance.
- **To use with Orbital Sander only.**

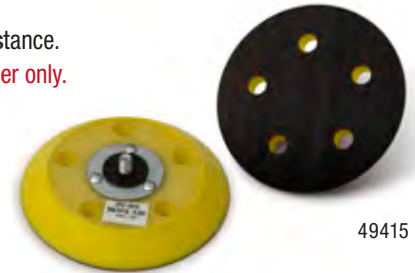

UPC	Description	RPM	Box Qty
5" PSA Disc Pads			
49406	5 x 5/16-24 Medium	10,000	1
49407	5 x 5/16-24 Firm	12,000	1
49408	5 x 5/16-24 Medium – 5 VAC	10,000	1
6" PSA Disc Pads			
49423	6 x 5/16-24 Medium	10,000	1
49424	6 x 5/16-24 Firm	10,000	1
49425	6 x 5/16-24 Firm – 6 VAC	10,000	1

UPC #	Description	RPM	Box Qty
5" Hook & Loop Disc Pads			
49413	5 x 5/16-24 Medium	10,000	1
49414	5 x 5/16-24 Firm	12,000	1
49415	5 x 5/16-24 Medium – 5 VAC	10,000	1
6" Hook & Loop Disc Pads			
49426	6 x 5/16-24 Medium	10,000	1
49427	6 x 5/16-24 Firm	10,000	1
49428	6 x 5/16-24 Medium – 6VAC	10,000	1

Shop Rolls

- High flexibility cotton cloth and bonding technology with special flexible Phenolic Resin. This bonding technology provides limited grain shedding.
- Semi-friable Aluminum Oxide abrasive grains provides aggressive sanding while long lasting performance.
- Perfect for plumbing, working on lathes, details of fine craftsmanship.

Grit	1" x 50 YDS.	1-1/2" x 50 YDS.	2" x 50 YDS.	Box Qty	Master Pack
40	63092	63095	63098	1	10
60	63062	63072	63082	1	10
80	63063	63073	63083	1	10
100	63064	63074	63084	1	10
120	63065	63075	63085	1	10
150	63066	63076	63086	1	10
180	63067	63077	63087	1	10
220	63068	63078	63088	1	10
240	63069	63079	63089	1	10
320	63070	63080	63090	1	10
400	63071	63081	63091	1	10



ALUMINUM OXIDE



Finishing Discs – Hook and Loop

- Impregnated with abrasive grain for fast material removal.
- Designed for long working life and resists loading.
- Use on steel, stainless steel, aluminum, titanium and alloys, fiber glass, plastic and glass fiber.

UPC	Size	Specs	RPM	Box Qty
4"				
70000	4	Coarse – Brown	13,000	10
70001	4	Medium – Maroon	13,000	10
70002	4	Very Fine – Blue	13,000	10
70003	4	Ultra Fine – Grey	13,000	10
70004	4	Heavy Duty – Brown – Coarse	13,000	10
4-1/2"				
70006	4-1/2	Coarse – Brown	12,000	10
70007	4-1/2	Medium – Maroon	12,000	10
70008	4-1/2	Very Fine – Blue	12,000	10
70009	4-1/2	Ultra Fine – Grey	12,000	10
70010	4-1/2	Heavy Duty – Brown – Coarse	12,000	10
70011	4-1/2	Heavy Duty – Maroon – Medium	12,000	10
5"				
70012	5	Coarse – Brown	10,000	10
70013	5	Medium – Maroon	10,000	10
70014	5	Very Fine – Blue	10,000	10
70015	5	Ultra Fine – Grey	10,000	10
70017	5	Heavy Duty – Maroon – Medium	10,000	10

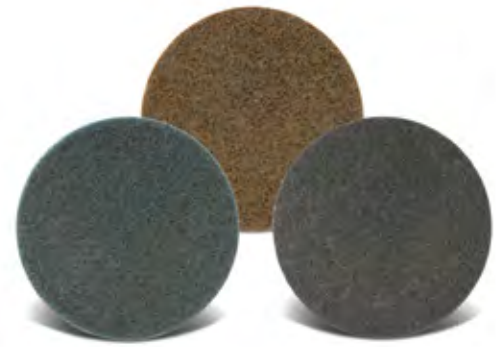

UPC	Size	Specs	RPM	Box Qty
6"				
70018	6	Coarse – Brown	7,000	10
70019	6	Medium – Maroon	7,000	10
7"				
70022	7	Heavy Duty – Brown – Coarse	6,000	10
70023	7	Coarse – Brown	6,000	10
70024	7	Medium – Maroon	6,000	10
70025	7	Very Fine – Blue	6,000	10
8"				
70026	8	Coarse – Brown	4,800	10

Finishing Discs – Hook and Loop with Arbor Hole

UPC	Size	Specs	RPM	Box Qty	Pad
4-1/2 x 7/8					
70029	4-1/2 x 7/8	Coarse – Tan	12,000	10	48224
70030	4-1/2 x 7/8	Medium – Maroon	12,000	10	48224
70031	4-1/2 x 7/8	Ultra Fine – Grey	12,000	10	48224
5 x 7/8					
70032	5 x 7/8	Coarse – Tan	10,000	10	48225
70033	5 x 7/8	Medium – Maroon	10,000	10	48225
70034	5 x 7/8	Ultra Fine – Grey	10,000	10	48225



UPC	Size	Specs	RPM	Box Qty	Pad
7 x 7/8					
70035	7 x 7/8	Coarse – Tan	6,000	10	48226
70036	7 x 7/8	Medium – Maroon	6,000	10	48226
70037	7 x 7/8	Ultra Fine – Grey	6,000	10	48226

Backing Pads

- 4-8" pads with internal 5/8-11 threads.
- 1/4" foam for medium stiffness and maximum grip for hook and loop discs.

UPC	Size	Box Qty
49532	4 x 5/8 -11	1
49533	4-1/2 x 5/8 -11	1
49534	5 x 5/8 -11	1
49535	6 x 5/8 -11	1
49536	7 x 5/8 -11	1
49537	8 x 5/8 -11	1



Other sizes available on page 19.

9" x 11" Sanding Sheets

CSA Stearated Paper Sheets

Aluminum Oxide, A-Weight, Open Coat

- Aluminum oxide grain treated with zinc stearate for non-loading lubricating effect. The best finishing sheet in the industry.

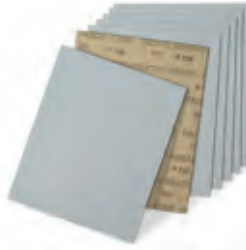

Cabinet & Finishing Paper Sheets

Aluminum Oxide, A & D-Weight, Open Coat

- Aluminum oxide grain coated on D-Weight paper for "Cabinet Paper" and on A-Weight paper for "Finishing Paper".



Flexible Cloth Sheets

Aluminum Oxide, J-Weight, Closed Coat

- Used extensively for metal working and maintenance departments.



WSC – Silicon Carbide Waterproof Paper Sheets

Silicon Carbide, B&C-Weight, Closed Coat

- Hand or random orbital sanders. Can be used wet or dry. For metal working applications and final sanding of lacquered wood products. Backing is latex paper.

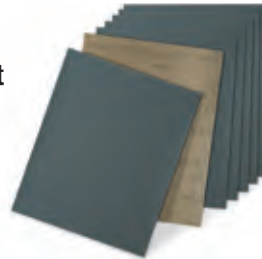

SC – Silicon Carbide Stearated Sheets

Silicon Carbide, A-Weight, Closed Coat

- Silicon carbide grain treated with zinc stearate for non-loading lubricating effect. For sanding and finishing of very hard surfaces such as lacquer and enamels.

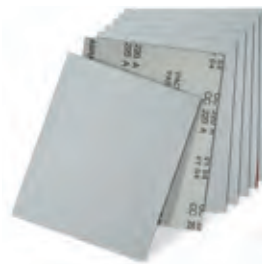

Sanding Sponges & Blocks



HI-FLEX Sanding Sponges

White Aluminum Oxide, Closed Coat

UPC	Grit	Pack
5-1/2 x 4-1/2 x 3/16"		
44827	100	50
44828	220	50

ALUMINUM OXIDE

SILICON CARBIDE



UPC	Grit	Sleeve	Pack
A-Weight			
44836	400	100	1
44837	320	100	1
44838	280	100	1

UPC	Grit	Sleeve	Pack
44839	220	100	1
44840	150	100	1
44841	120	100	1
44842	100	100	1

UPC	Grit	Sleeve	Pack
A-Weight			
44881	220	100	1
44882	180	100	1
44883	150	100	1
44884	120	100	1
44885	100	100	1

UPC	Grit	Sleeve	Pack
D-Weight			
44886	80	50	1
44887	60	50	1

UPC	Grit	Sleeve	Pack
J-Weight			
44917	400	50	1
44919	320	50	1
44921	240	50	1
44922	220	50	1
44923	180	50	1

UPC	Grit	Sleeve	Pack
44860	150	50	1
44924	120	50	1
44861	100	50	1
44862	80	50	1
44925	60	25	1

UPC	Grit	Sleeve	Pack
B-Weight			
44889	2000	50	1
44865	1200	50	1
44866	1000	50	1
44867	800	50	1
44843	600	50	1
44868	500	50	1
44844	400	50	1
44845	320	50	1
44871	240	50	1

UPC	Grit	Sleeve	Pack
C-Weight			
44846	220	50	1
44847	180	50	1
44872	150	50	1
44848	120	50	1
44849	100	50	1
44873	80	50	1

UPC	Grit	Sleeve	Pack
A-Weight			
44850	400	100	1
44851	320	100	1
44852	280	100	1
44854	220	100	1

UPC	Grit	Sleeve	Pack
44855	180	100	1
44856	150	100	1
44857	120	100	1
44858	100	100	1
44859	80	50	1

Sanding Blocks

Brown Aluminum Oxide, Closed Coat

UPC	Grit	Pack
2-3/4 x 4 x 1"		
44825	100	50
44826	180	50

Sanding Sponges

Silicon Carbide, Closed Coat

UPC	Grit	Pack
3-7/8 x 4-3/4 x 1/2"		
44821	100	50
44822	150	50
44823	180	50
44824	220	50

Premium Hand Pads

BEST



- Strong, yet flexible premium pad construction for surface preparation.
- Maroon pads for rust removal, cleaning and surface preparation.
- Grey pads for fine finishing and surface preparation.
- Green pads for heavy duty cleaning.
- White pads are constructed from a non-abrasive material for light duty cleaning.
- Tan pads for rust removal and coarse finishes
- Black pads for aggressive use; heavy cleaning, deburring and finishing.

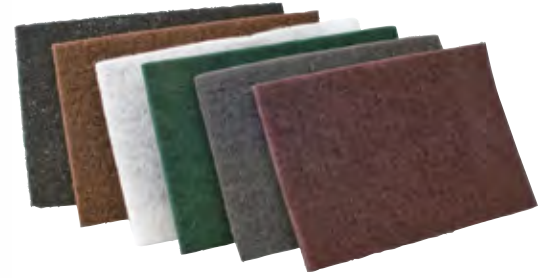

6 x 9 Premium Non-Woven Hand Pads

UPC	Specs	Box Qty
36287	Maroon – All Purpose	20
36283	Grey – Ultra Fine	20
36284	Green – General Cleaning	20
36285	White – Light Duty	20
36286	Tan – Heavy Duty	20
71151	Black – Heavy Duty	20

Bulk Shrink Wrap Packs of 10

UPC	Specs	Box Qty
36288	Maroon – Bulk	100

Hand Pads – Economy

GOOD



- Non-woven material engineered for surface preparation.
- **Maroon – All Purpose**
 - Impregnated with abrasive grain and synthetic resin for long-lasting, versatile use.
 - Recommended for removing rust and corrosion and in surface preparation and cleaning applications.
- **Green – General Cleaning**
 - Impregnated with medium abrasive grain for easy use and rinsing.
 - Recommended for cleaning all types of equipment, metal surfaces and other durable surfaces.
- **White – Light Duty**
 - Non-abrasive material does not make scratches and is long lasting.
 - Recommended for cleaning sensitive surfaces, metal, formica, solid surfaces, glass, and mirror.

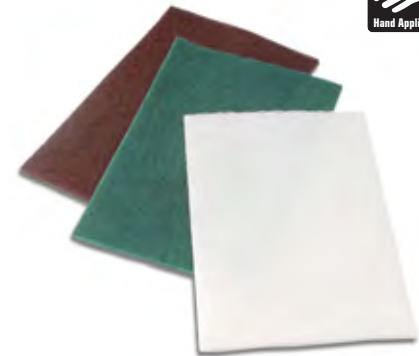

6 x 9 Non-Woven Hand Pads

UPC	Specs	Box Qty*
36241	Maroon – All Purpose	60
36242	Green – General Cleaning	60
36243	White – Light Duty	60

* Carton contains 6 packages of 10



CGW Abrasives NEW express belt program offers you fast and competitively priced made-to-order service on narrow and wide belts used for stock removal, deburring, blending, shaping and polishing on a range of materials.

made-to-order

Wide Belts

Width	Minimum Order Qty	Case Qty	Lead Times
Over 14", less than 26" – 100 grit and finer	6	6	5 days
Over 14", less than 26" – 80 and coarser	4	4	5 days
26" and over – 100 grit and finer	5	5	5 days
26" and over – 80 and coarser	3	3	5 days

Wide belts: max width 52", length 103" (other sizes & lengths available with different MOQ/case qty)

Narrow Belts

Width	Minimum Order Qty	Case Qty	Lead Times
0.5" to 2" width and up to 60" length	100	200	5 days
Over 2" to 8"	10	50	5 days
Over 8" to 12"	10	20	5 days

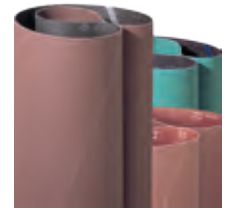

Abrasive Grain Spacing & Weight



Open Coat

Greater flexibility, faster cutting, coarser finish and provide a greater resistance to loading.



Closed Coat

Better finish and a higher amount of stock removal during the life of the product.

Flexibility	Backing Weight	Application / Use
Higher	F	Light
↑↓	J	↑↓
Lower	X	Heavy

Metalworking

Tier	Grain	Backing	Coat	Weight	Shape	Grit Range	Application
BEST	Ceramic	Polyester	Closed	Y	Narrow Belts, Wide Belts	24, 36, 40, 50, 60, 80, 100, 120	Heavy stock removal on metals
	Ceramic	Polyester	Semi-Open	X	Narrow Belts, Wide Belts	36, 50, 60, 80, 120	Stainless steel, exotic metals
BETTER	Zirconia w/Grinding Aid	Polyester	Closed	Y	Narrow Belts, Wide Belts	36, 40, 60, 80, 100	Excels on stainless steel
	Zirconia	Polyester	Closed	Y	Narrow Belts, Wide Belts	36, 40, 60, 80, 100, 120	Metal, stainless steel, wood
GOOD	Aluminum Oxide	Polyester	Closed	X	Narrow Belts, Wide Belts	36, 40, 60, 80, 100, 120, 150, 180	General purpose: metal, aluminum, wood
	Aluminum Oxide	Poly/Cotton	Closed	J	Narrow Belts	60, 80, 100, 120, 150, 180, 220, 320, 400	Aluminum, brass, wood

Woodworking

Tier	Grain	Backing	Coat	Weight	Shape	Grit Range	Application
BETTER	Aluminum Oxide	Polyester	Open	Y	Narrow Belts, Wide Belts	60, 80, 100, 120	Long life on solid woods, plywood
	Silicon Carbide	Polyester	Closed	Y	Wide Belts	50, 60, 80, 100, 150	MDF, particle board, panel
GOOD	Aluminum Oxide	Poly/Cotton	Open	X	Narrow Belts, Wide Belts	60, 80, 100, 120, 150, 180	General purpose: all wood types
	Silicon Carbide	Paper	Closed	F	Wide Belts	120, 150, 180, 220	Best choice for superior finish
	Aluminum Oxide	Paper	Open	F	Wide Belts	80, 100, 120, 150, 180	Antistatic coating to minimize dust

For material spec refer to technical sell sheet # 99114

Wide Belts - Cloth Backed

ALUMINUM OXIDE

in-stock

X-Weight

GOOD

- X-Weight, poly cotton backing. **Open coat.**
- Our most popular cloth wide belt (most common sizes in stock).
- For hardwood sanding (grits: 36 – 220).



UPC	Size	Weight	Grit	Unit Qty
37 x 60				
52870	37 x 60	X	80	3
52871	37 x 60	X	100	5
52872	37 x 60	X	120	5
52873	37 x 60	X	150	5
52874	37 x 60	X	180	5
37 x 75				
52875	37 x 75	X	80	3
52876	37 x 75	X	100	5
52877	37 x 75	X	120	5
52878	37 x 75	X	150	5
52879	37 x 75	X	180	5
43 x 75				
52885	43 x 75	X	80	3
52886	43 x 75	X	100	5
52887	43 x 75	X	120	5
52888	43 x 75	X	150	5
52889	43 x 75	X	180	5

UPC	Size	Weight	Grit	Unit Qty
52 x 103				
52890	52 x 103	X	80	3
52892	52 x 103	X	120	5
52894	52 x 103	X	180	5
52 x 75				
52895	52 x 75	X	80	3
52897	52 x 75	X	120	5
52899	52 x 75	X	180	5
54 x 103				
52901	54 x 103	X	120	3
52902	54 x 103	X	150	5
52903	54 x 103	X	180	5

X & Y-Weight

BETTER

- X & Y-weight backing. **Closed coat.**
- Y-Weight polyester resin bond for 80 grit and coarser.
- X-Weight polyester resin bond for 100 grit and finer.
- Polyester resin bond backing, may be used wet or dry.



- Grinding aid for cool cutting action and longer life.
- For stainless steel, nickel alloy and tool steel.
- Ideal for wide belts for metal working; cost effective.
- For belts up to 53" wide.

UPC	Size	Weight	Grit	Unit Qty
37 x 60				
52861	37 x 60	Y	80	3
52862	37 x 60	Y	100	5
52863	37 x 60	Y	120	5
52864	37 x 60	Y	150	5
52865	37 x 60	X	180	5

UPC	Size	Weight	Grit	Unit Qty
37 x 75				
52866	36 x 75	Y	120	5
52867	36 x 75	Y	150	5
52868	36 x 75	X	180	5
52869	36 x 75	X	220	5

Narrow Belts: File & Portable, Benchstand/Backstand Belts

in-stock

ALUMINUM OXIDE

GOOD

ZIRCONIA

BETTER

- Durable grain on X-Weight backing, closed coat for rapid stock removal and long life.
- For ferrous metals, stainless steel, non ferrous metals, composites, plastics and wood.

- Premium zirconia on Y-Weight backing, closed coat for aggressive use and heavy duty applications.
- For steel and stainless steel.



File Belts	= 1/8" to 1" wide, 12" to 30" long
Portable Belts	= 3" to 4" wide, 15-1/2" to 24" long
Benchstand/Backstand Belts	= 1" to 10" wide, 36" to 132" long

File Belts

Converted in USA



A3 X-Weight UPC	Z3® Y-Weight UPC	Size	Grit	Box Qty
METALWORKING				
<i>1/4 x 18</i>				
61009	61507	1/4 x 18	36	50
61010	61508	1/4 x 18	40	50
61011	61509	1/4 x 18	50	50
61012	61510	1/4 x 18	60	50
61013	61511	1/4 x 18	80	50
61015		1/4 x 18	120	50
<i>1/4 x 24</i>				
61017	61513	1/4 x 24	36	50
61018	61514	1/4 x 24	40	50
61019	61515	1/4 x 24	50	50
61020	61516	1/4 x 24	60	50
61021	61517	1/4 x 24	80	50
61023		1/4 x 24	120	50
<i>1/2 x 12</i>				
61025	61519	1/2 x 12	36	50
61026	61520	1/2 x 12	40	50
61027	61521	1/2 x 12	50	50
61028	61522	1/2 x 12	60	50
61029	61523	1/2 x 12	80	50
61031		1/2 x 12	120	50
<i>1/2 x 18</i>				
61033	61525	1/2 x 18	36	50
61034	61526	1/2 x 18	40	50
61035	61527	1/2 x 18	50	50
61036	61528	1/2 x 18	60	50
61037	61529	1/2 x 18	80	50
61039		1/2 x 18	120	50

A3 X-Weight UPC	Z3® Y-Weight UPC	Size	Grit	Box Qty
<i>1/2 x 24</i>				
61041	61531	1/2 x 24	36	50
61042	61532	1/2 x 24	40	50
61043	61533	1/2 x 24	50	50
61044	61534	1/2 x 24	60	50
61045	61535	1/2 x 24	80	50
61047		1/2 x 24	120	50
<i>3/4 x 18</i>				
61057	61543	3/4 x 18	36	50
61058	61544	3/4 x 18	40	50
61059	61545	3/4 x 18	50	50
61060	61546	3/4 x 18	60	50
61061	61547	3/4 x 18	80	50
61063		3/4 x 18	120	50
<i>3/4 x 20-1/2</i>				
	61812	3/4 x 20-1/2	36	50
	61813	3/4 x 20-1/2	40	50
	61814	3/4 x 20-1/2	50	50
	61815	3/4 x 20-1/2	60	50
	61816	3/4 x 20-1/2	80	50
<i>1 x 30</i>				
61081	61555	1 x 30	36	50
61082	61556	1 x 30	40	50
61083	61557	1 x 30	50	50
61084	61558	1 x 30	60	50
61085	61559	1 x 30	80	50
61087		1 x 30	120	50
WOODWORKING				
<i>3/4 x 20-1/2</i>				
61806		3/4 x 20-1/2	36	50
61807		3/4 x 20-1/2	40	50
61808		3/4 x 20-1/2	50	50
61809		3/4 x 20-1/2	60	50
61810		3/4 x 20-1/2	80	50
61811		3/4 x 20-1/2	120	50



Portable Belts



Converted in USA

A3 X-Weight UPC	Size	Grit	Box Qty
METALWORKING			
3 x 21			
61178	3 x 21	36	50
61179	3 x 21	40	50
61180	3 x 21	50	50
61181	3 x 21	60	50
61182	3 x 21	80	50
61184	3 x 21	120	50
3 x 24			
61191	3 x 24	36	50
61192	3 x 24	40	50
61193	3 x 24	50	50
61194	3 x 24	60	50
61195	3 x 24	80	50
61197	3 x 24	120	50
3-1/2 x 15-1/2			
61800	3-1/2 x 15-1/2	36	50
61801	3-1/2 x 15-1/2	40	50
61802	3-1/2 x 15-1/2	50	50
61803	3-1/2 x 15-1/2	60	50
61804	3-1/2 x 15-1/2	80	50
61805	3-1/2 x 15-1/2	120	50

A3 X-Weight UPC	Z3® Y-Weight UPC	Size	Grit	Box Qty
METALWORKING				
4 x 24				
61249	60728	4 x 24	36	50
61250	60729	4 x 24	40	50
61251	60730	4 x 24	50	50
61252	60731	4 x 24	60	50
61253	60732	4 x 24	80	50
61255		4 x 24	120	50



Benchstand and Backstand Belts

Converted in USA

A3 X-Weight UPC	Z3® Y-Weight UPC	Size	Grit	Box Qty
METALWORKING				
1 x 42				
61089	61561	1 x 42	36	50
61090	61562	1 x 42	40	50
61091	61563	1 x 42	50	50
61092	61564	1 x 42	60	50
61093	61565	1 x 42	80	50
61095		1 x 42	120	50
2 x 48				
61117	61579	2 x 48	36	50
61118	61580	2 x 48	40	50
61119	61581	2 x 48	50	50
61120	61582	2 x 48	60	50
61121	61583	2 x 48	80	50
61123		2 x 48	120	50
2 x 60				
61125		2 x 60	36	50
61126		2 x 60	40	50
61127		2 x 60	50	50
61128		2 x 60	60	50
61129		2 x 60	80	50
61131		2 x 60	120	50

A3 X-Weight UPC	Z3® Y-Weight UPC	Size	Grit	Box Qty
METALWORKING				
2 x 72				
61133		2 x 72	36	50
61134		2 x 72	40	50
61135		2 x 72	50	50
61136		2 x 72	60	50
61137		2 x 72	80	50
61139		2 x 72	120	50
4 x 36				
61262		4 x 36	36	50
61263		4 x 36	40	50
61264		4 x 36	50	50
61265		4 x 36	60	50
61266		4 x 36	80	50
61268		4 x 36	120	50
6 x 48				
61291	61633	6 x 48	36	50
61292	61634	6 x 48	40	50
61293	61635	6 x 48	50	50
61294	61636	6 x 48	60	50
61295	61637	6 x 48	80	50
61297		6 x 48	120	50

SURFACE CONDITIONING

Surface Conditioning Belts

Surface Conditioning material utilizes a substrate base (nylon fiber), a resin bond (phenolic or polyurethane) and abrasive grain. The fiber and resin are fully waterproof so the product can be used wet or dry. The structure is open so that the product resists loading and runs cool compared to coated abrasives.



- For cleaning, finishing, blending and deburring applications.
- Belts provide a linear grain scratch pattern for blending stainless welds.
- Blends and finishes without undercutting or gouging work pieces.
- Belts 40 inches and less are made from X-Flex material for flexibility. For hand held tools.
- Belts 40 inches and higher are made from Low Stretch material for reliable dimension holding – no stretching. For stationary machines.



Low Stretch Material is available as special order with 5-day conversion lead-time.

 *Converted in USA*

Size	Material	Pkg	COARSE	MEDIUM	VERY FINE
			BROWN	MAROON	BLUE
X-Flex Belts					
1/4 x 18	X-Flex	10	59220	59221	59222
1/4 x 24	X-Flex	10	59223	59224	59225
1/2 x 12	X-Flex	10	59226	59227	59228
1/2 x 18	X-Flex	10	59229	59230	59231
1/2 x 24	X-Flex	10	59232	59233	59234
3/4 x 18	X-Flex	10	59235	59236	59237
3/4 x 20-1/2	X-Flex	10	59238	59239	59240
1 x 18	X-Flex	10	59241	59242	59243
1 x 30	X-Flex	10	59244	59245	59246
3 x 10-11/16	X-Flex	10	59271	59272	59273
3 x 18	X-Flex	10	59274	59275	59276
3 x 21	X-Flex	10	59306	59307	59308
3 x 24	X-Flex	10	59277	59278	59279
3-1/2 x 15-1/2	X-Flex	10	59283	59284	59285
4 x 24	X-Flex	10	59286	59287	59288

The product is available in three grades: **Coarse** (Brown) – equivalent to 120 grit finish; **Medium** (Maroon) – equivalent to 180 grit finish; **Very Fine** (Blue) – equivalent to 320 grit finish. X-Flex material is modified to give increased flexibility. For longer belts. Low Stretch material resists stretch in the length direction.

EZ Strip Wheels

- Non woven wheels for cleaning welds and fast removal of rust, scaling, oxidation, paints, sealants, and other clogging materials.
- EZ strip wheels can be used on stainless steel, steel, aluminum, titanium, non-ferrous metals, Fiber glass, stone and wood.
- **Red EZ strip wheels** are more rigid for faster working on angled and irregular surfaces.
- Black EZ strip wheels clean and can provide a satin finish.

UPC	Size	RPM	Box Qty
Red			
59204	4-1/2 x 7/8	11,000	10
59205	4-1/2 x 5/8-11	11,000	10
59208	5 x 7/8	9,800	10
59209	5 x 5/8-11	9,800	10
59206	7 x 7/8	7,000	10
59207	7 x 5/8-11	7,000	10

UPC	Size	RPM	Box Qty
Black			
59200	4-1/2 x 7/8	11,000	10
59201	4-1/2 x 5/8-11	11,000	10
59210	5 x 7/8	9,800	10
59211	5 x 5/8-11	9,800	10
59202	7 x 7/8	7,000	10
59203	7 x 5/8-11	7,000	10



EZ Strip Wheels – Roll On

- Roll-on attachment for easy attachment.
- **Red EZ strip wheels** are more rigid for faster working on angled and irregular surfaces.
- Black EZ strip wheels clean and can provide a satin finish.

UPC	Size	RPM	Box Qty
Red			
59060	2 x 1/2	10,500	10
59062	3 x 1/2	7000	10

UPC	Size	RPM	Box Qty
Black			
59061	2 x 1/2	10,500	10
59063	3 x 1/2	7000	10

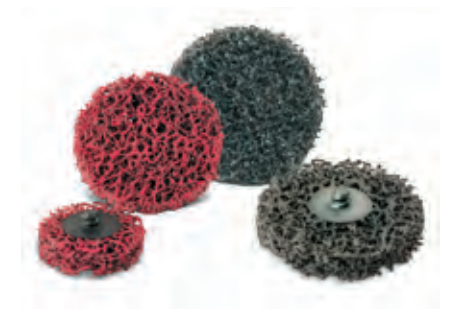

EZ Strip Wheels with 1/2" Arbor Hole

- Die cut into a disc shape with no backing
- Discs can easily be paired for extended working life. Use the appropriate shaft when pairing.

UPC	Size	RPM	Box Qty
Black			
70038	4 x 1/2 x 1/2	8,000	10
70040	6 x 1/2 x 1/2	5,500	10
70042	8 x 1/2 x 1/2	4,000	10

UPC	Size	RPM	Box Qty
Red			
70046	4 x 1/2 x 1/2	8,000	10
70047	6 x 1/2 x 1/2	5,500	10
70048	8 x 1/2 x 1/2	4,000	10

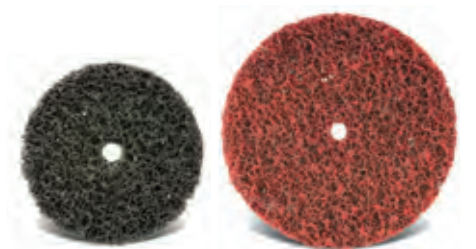

EZ Strip Wheels with 1/4" Spindle

- Spindle mount for quick attachment.

UPC	Size	RPM	Box Qty
Single			
70049	2 x 1/2 x 1/4	16,000	10
70050	3 x 1/2 x 1/4	10,500	10
70051	4 x 1/2 x 1/4	8,000	10

UPC	Size	RPM	Box Qty
Double			
70052	2 x 1 x 1/4	16,000	10
70053	3 x 1 x 1/4	10,500	10
70054	4 x 1 x 1/4	8,000	10





FLAP WHEELS & DRUMS



Aluminum Oxide Flap Wheels, 1/4" Shank

ALUMINUM OXIDE

- Firm, quality Aluminum Oxide coated abrasive material. The flaps, arranged like a fan around the shaft of the tool, provide for consistent cutting action, maximum performance and long life.
- Use on steel, stainless steel, iron, brass, aluminum, plastic, fiberglass, wood and glass. Excellent for working in small, difficult to reach places.

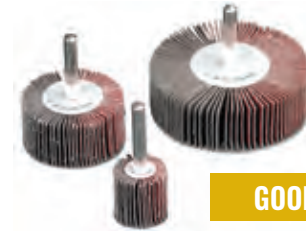

GOOD

UPC	Grit	RPM	Box Qty
3/4 x 3/4 x 1/4			
37098	60	30,000	10
37099	80	30,000	10
37100	120	30,000	10
37103	180	30,000	10
37104	240	30,000	10
37105	320	30,000	10
1 x 5/8 x 1/4			
39903	60	30,000	10
39904	80	30,000	10
39905	120	30,000	10
1 x 1 x 1/4			
39907	40	30,000	10
39908	60	30,000	10
39909	80	30,000	10
39910	120	30,000	10
39912	180	30,000	10
39913	240	30,000	10
39914	320	30,000	10
1-1/2 x 1/2 x 1/4			
39915	60	25,000	10
39916	80	25,000	10
39917	120	25,000	10
41032	180	25,000	10
41035	240	25,000	10
41510	320	25,000	10
1-1/2 x 1 x 1/4			
39920	40	25,000	10
39921	60	25,000	10
39922	80	25,000	10
39923	120	25,000	10
41036	180	25,000	10
41037	240	25,000	10
41630	320	25,000	10

UPC	Grit	RPM	Box Qty
2 x 1/2 x 1/4			
39924	40	25,000	10
39925	60	25,000	10
39926	80	25,000	10
39927	120	25,000	10
41038	180	25,000	10
41039	240	25,000	10
41631	320	25,000	10
2 x 3/4 x 1/4			
39928	60	25,000	10
39929	80	25,000	10
39930	120	25,000	10
2 x 1 x 1/4			
39931	40	25,000	10
39932	60	25,000	10
39933	80	25,000	10
39934	120	25,000	10
39935	180	25,000	10
39936	240	25,000	10
39937	320	25,000	10
2 x 1-1/2 x 1/4			
40003	40	25,000	10
40004	60	25,000	10
40005	80	25,000	10
40006	120	25,000	10
2 x 2 x 1/4			
39938	60	25,000	10
39939	80	25,000	10
2-1/2 x 1/2 x 1/4			
41015	60	20,000	10
41016	80	20,000	10
41017	120	20,000	10

UPC	Grit	RPM	Box Qty
2-1/2 x 1 x 1/4			
39941	60	20,000	10
39942	80	20,000	10
39943	120	20,000	10
41500	180	20,000	10
41501	240	20,000	10
41511	320	20,000	10
2-1/2 x 1-1/2 x 1/4			
41121	60	20,000	10
41122	80	20,000	10
3 x 1/2 x 1/4			
41018	60	20,000	10
41019	80	20,000	10
41020	120	20,000	10
41502	180	20,000	10
3 x 1 x 1/4			
39947	40	20,000	10
39948	60	20,000	10
39949	80	20,000	10
39950	120	20,000	10
39951	180	20,000	10
39952	240	20,000	10
39953	320	20,000	10
3 x 1-1/2 x 1/4			
41513	60	20,000	10
41514	80	20,000	10
41515	120	20,000	10
3 x 2 x 1/4			
41044	40	20,000	10
39954	60	20,000	10
39955	80	20,000	10
39956	120	20,000	10

Zirconia Flap Wheels, 1/4" Shank

ZIRCONIA

UPC	Grit	RPM	Box Qty
1 x 1 x 1/4			
41519	40	30,000	10
41520	60	30,000	10
41521	80	30,000	10
1-1/2 x 1 x 1/4			
41522	40	25,000	10
41523	60	25,000	10
41524	80	25,000	10

UPC	Grit	RPM	Box Qty
2 x 1 x 1/4			
41525	40	25,000	10
41526	60	25,000	10
41527	80	25,000	10
3 x 1 x 1/4			
41528	40	20,000	10
41529	60	20,000	10
41530	80	20,000	10



BETTER

- Zirconia grain provides sharper cutting and longer life than aluminum oxide flap wheels.
- Excellent for smoothing and deburring.
- Durable cotton backing.
- For work on steel, stainless steel, non-ferrous metals and alloys.

Aluminum Oxide Flap Wheels, 1/4 – 20" Shank



ALUMINUM OXIDE



48250

UPC	Grit	RPM	Box Qty
1 x 5/8 x 1/4-20			
39960	60	30,000	10
39961	80	30,000	10
1 x 1 x 1/4-20			
39964	40	30,000	10
39965	60	30,000	10
39966	80	30,000	10
39967	120	30,000	10
1-1/2 x 1 x 1/4-20			
39977	40	25,000	10
39978	60	25,000	10
39979	80	25,000	10
39980	120	25,000	10

UPC	Grit	RPM	Box Qty
2 x 1/2 x 1/4-20			
40007	60	25,000	10
40008	80	25,000	10
40009	120	25,000	10
2 x 1 x 1/4-20			
39988	40	25,000	10
39989	60	25,000	10
39990	80	25,000	10
39991	120	25,000	10
2-1/2 x 1 x 1/4-20			
39998	60	20,000	10
39999	80	20,000	10
41000	120	20,000	10

UPC	Grit	RPM	Box Qty
3 x 1/2 x 1/4-20			
41608	60	20,000	10
3 x 1 x 1/4-20			
41004	40	20,000	10
41005	60	20,000	10
41006	80	20,000	10
41007	120	20,000	10
1/4-20 Adaptor			
48250	1/4-20 Adaptor		1

Interleaf Flap Wheels

ALUMINUM OXIDE

USA MADE



- Alternating flaps of non-woven and coated abrasive materials for fast, uniform surface preparation and finishes.
- Medium grade wheels easily clean, blend, and debur aluminum & stainless steels, and ferrous & non-ferrous metals.
- Very fine grade wheels for satin finishing on aluminum & stainless steels, and ferrous and non-ferrous metals.

UPC	Spec	Grit	RPM	Box Qty
2 x 1 x 1/4				
36207	Medium	60	11,000	10
36208	Medium	80	11,000	10
36209	Very Fine	120	11,000	10
36210	Very Fine	180	11,000	10

UPC	Spec	Grit	RPM	Box Qty
3 x 1 x 1/4				
36211	Medium	60	8,000	10
36212	Medium	80	8,000	10
36213	Very Fine	120	8,000	10
36214	Very Fine	180	8,000	10

UPC	Spec	Grit	RPM	Box Qty
3 x 2 x 1/4				
36250	Extra Coarse		8,000	10
36215	Medium	60	8,000	10
36216	Medium	80	8,000	10
36217	Very Fine	120	8,000	10
36218	Very Fine	180	8,000	10

Mini Flap Wheels

- Quality Aluminum Oxide grain with X-flex weight backing.
- Use on stainless steel, steel, alloyed steel, nonferrous materials, aluminum, titanium, and glass.



ALUMINUM OXIDE



UPC	Grit	RPM	Box Qty
3/8 x 3/8 x 1/8			
70057	60	38,000	10
70058	80	38,000	10
70059	120	38,000	10
5/8 x 5/8 x 1/8			
70062	60	38,000	10
70063	80	38,000	10
70064	120	38,000	10

UPC	Grit	RPM	Box Qty
3/4 x 3/16 x 1/8			
70068	60	38,000	10
70069	80	38,000	10
70070	120	38,000	10
1-3/16 x 3/16 x 1/8			
70086	60	38,000	10
70087	80	38,000	10
70088	120	38,000	10

UPC	Grit	RPM	Box Qty
1-3/16 x 3/8 x 1/8			
70090	60	38,000	10
70091	80	38,000	10
70092	120	38,000	10

Non Woven Flap Wheels

- 100% non woven Aluminum Oxide flap wheels provide excellent flexibility and conforms to work surface.
- Available in coarse, medium, and fine.

UPC	Specs	Box Qty
1 x 1 x 1/4 12,000 R.P.M.		
36450	Coarse (Tan)	10
36451	Medium (Maroon)	10
36452	Fine (Blue)	10
2 x 1 x 1/4 12,000 R.P.M.		
36453	Coarse (Tan)	10
36454	Medium (Maroon)	10
36455	Fine (Blue)	10

UPC	Specs	Box Qty
3 x 1 x 1/4 10,000 R.P.M.		
36456	Coarse (Tan)	10
36457	Medium (Maroon)	10
36458	Fine (Blue)	10
3 x 2 x 1/4 10,000 R.P.M.		
36459	Coarse (Tan)	10
36460	Medium (Maroon)	10
36461	Fine (Blue)	10



**USA
MADE**

Zirconia Flap Wheel Drums

- Firm, Zirconia Aluminum Oxide coated flaps for long working life.
- Fast and consistent finish.

UPC	Size	Tool Fixture	Grit	RPM	Box Qty
72106	4 x 4 x 3/4	19.1 mm	40	5,800	5
72107	4 x 4 x 3/4	19.1 mm	60	5,800	5
72108	4 x 4 x 3/4	19.1 mm	80	5,800	5
72109	4 x 4 x 3/4	19.1 mm	120	5,800	5



ZIRCONIA



Keyhole
Arbor



Interleaf Flap Wheel Drums

- Alternating flaps of non-woven and Aluminum Oxide coated abrasive materials for fast, uniform finishes.

UPC	Size	Grit	RPM	Box Qty
72110	4 x 4 x 3/4	40 / Medium	5,800	5
72111	4 x 4 x 3/4	60 / Medium	5,800	5
72112	4 x 4 x 3/4	80 / Medium	5,800	5
72113	4 x 4 x 3/4	120 / Medium	5,800	5
72114	4 x 4 x 3/4	180 / Medium	5,800	5



ALUMINUM OXIDE



Keyhole
Arbor



Non-Woven Flap Wheel Drums

- Quality, non-woven material impregnated with Aluminum Oxide grain for consistent finishes.
- For polishing, blending, deburring, cleaning and brightening stainless steel, aluminum, brass, copper and other alloys.

UPC	Size	GRIT	RPM	Box Qty
72116	4 x 4 x 3/4	Coarse	5,800	5
72117	4 x 4 x 3/4	Medium	5,800	5
72118	4 x 4 x 3/4	Fine	5,800	5
72119	4 x 4 x 3/4	Very Fine	5,800	5



ALUMINUM OXIDE



Keyhole
Arbor



Flap Wheel Drum Adaptor Kit

- Flap Wheel Drums fit onto 5/8 – 11 spindles – allowing attachment on competitors surface grinding machines and variable speed right angle grinders.

UPC	Right Angle Adapter Kit
48572	3 piece set (includes 48573, 48574, 48575)

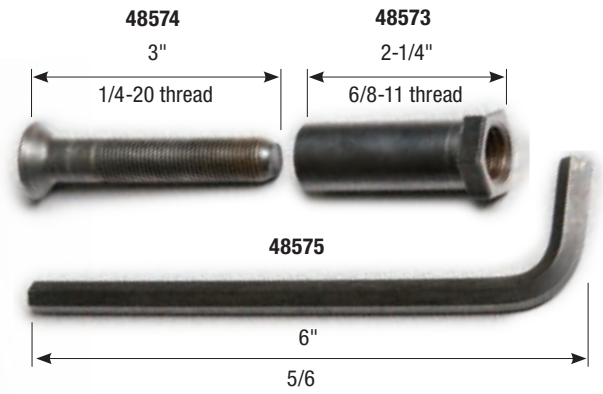

Unmounted Flap Wheels

- Quality Aluminum Oxide grain for consistent finishes.
- Unmounted flap wheels are recommended for cleaning, blending, deburring and finishing.

ALUMINUM OXIDE



UPC	Specs	RPM	Box Qty
4 x 1 x 5/8			
41025	40 Grit	8,000	10
41026	60 Grit	8,000	10
41027	80 Grit	8,000	10
6 x 1 x 1			
41045	40 Grit	5,000	5
41046	60 Grit	5,000	5
41047	80 Grit	5,000	5
41049	120 Grit	5,000	5

UPC	Specs	RPM	Box Qty
6 x 1-1/2 x 1			
41055	40 Grit	5,000	5
41056	60 Grit	5,000	5
41059	120 Grit	5,000	5
6 x 2 x 1			
41065	40 Grit	5,000	5
41066	60 Grit	5,000	5
41067	80 Grit	5,000	5
41069	120 Grit	5,000	5

UPC	Specs	RPM	Box Qty
8 x 1 x 1			
41085	40 Grit	4,000	3
41086	60 Grit	4,000	3
41087	80 Grit	4,000	3
41089	120 Grit	4,000	3
41091	180 Grit	4,000	3
8 x 2 x 1			
41096	60 Grit	4,000	3
41097	80 Grit	4,000	3
41099	120 Grit	4,000	3

Spiral Bands

- Aluminum Oxide grain.
- Spiral wound bands are used with rubber expanding drums.
- For grinding contours on most materials.

ALUMINUM OXIDE



44618

UPC	Grit	Box Qty	Expanding Drum
Diameter x Length (Inch)			
1/2 x 1/2			30,000 RPM
44601	60	100	44746
44602	80	100	44746
44603	120	100	44746
1/2 x 1			15,000 RPM
44604	60	100	44747
44605	80	100	44747
1/2 x 1-1/2			12,000 RPM
44607	60	100	44748
44608	80	100	44748
44609	120	100	44748
3/4 x 1			19,000 RPM
44610	36	100	44749
44611	60	100	44749
44612	80	100	44749
44613	120	100	44749

UPC	Grit	Box Qty	Expanding Drum
Diameter x Length (Inch)			
1 x 1			18,000 RPM
44617	36	100	44751
44618	60	100	44751
44619	80	100	44751
44620	120	100	44751
1-1/2 x 1			8,000 RPM
44621	36	100	44752
44622	60	100	44752
44623	80	100	44752
1 x 2			8,000 RPM
44716	36	100	44767
44717	60	100	44767
44718	80	100	44767
44741	120	100	44767

UPC	Grit	Box Qty	Expanding Drum
Diameter x Length (Inch)			
1-1/2 x 1-1/2			10,000 RPM
44625	36	100	44753
44626	60	100	44753
44627	80	100	44753
44628	120	100	44753
2 x 2			6,000 RPM
44629	36	50	44754
44630	60	50	44754
44631	80	50	44754
44632	120	50	44754
3 x 3			3,000 RPM
44633	36	50	44755
44634	60	50	44755
44635	80	50	44755
44636	120	50	44755

Rubber Expanding Drums

- Designed for easy on and off of spiral bands.

UPC	Size	RPM	Box Qty
44746	1/2 x 1/2 x 1/4	30,000	1
44747	1/2 x 1 x 1/4	20,000	1
44748	1/2 x 1-1/2 x 1/4	14,000	1
44749	3/4 x 1 x 1/4	19,000	1
44751	1 x 1 x 1/4	15,000	1

UPC	Size	RPM	Box Qty
44752	1-1/2 x 1 x 1/4	14,000	1
44767	1 x 2 x 1/4	8,000	1
44753	1-1/2 x 1-1/2 x 1/4	10,000	1
44754	2 x 2 x 1/4	6,000	1
44755	3 x 3 x 3/8	3,000	1



44755

Cross Pads

- For deburring, blending, and polishing of tubing and cylinders.

ALUMINUM OXIDE

UPC	Grit	Box Qty	Use with Mandrel
Length x Width (Inch)			
2 x 1/2		3-48 Eyelet	23,000 RPM
44726	60	100	44757
44727	80	100	44757
2 x 3/4		8-32 Eyelet	23,000 RPM
44732	60	100	44758
44733	80	100	44758

UPC	Grit	Box Qty	Use with Mandrel
Length x Width (Inch)			
2 x 1		8-32 Eyelet	23,000 RPM
44729	60	100	44757
44730	80	100	44757
3 x 1		1/4-20 Eyelet	14,000 RPM
44735	60	100	44758



Cartridge Rolls

ALUMINUM OXIDE

- Tightly wound abrasive material wears away exposing new layers of material.
- For grinding, deburring, blending, polishing and finishing.

Straight

Aluminum Oxide,
X-Weight, Closed Coat



44667

UPC	Grit	Box Qty	Use with Mandrel
Diameter x Length x Hole (Inch)			
3/16 x 1 x 3/32		23,000 RPM	
44640	80	100	44759
44641	120	100	44759
1/4 x 1 x 1/8		23,000 RPM	
44642	60	100	44760
44643	80	100	44760
44644	120	100	44760
44645	320	100	44760
1/4 x 1-1/2 x 1/8		23,000 RPM	
44646	60	100	44761
44647	80	100	44761
44648	120	100	44761
44649	180	100	44761
44650	240	100	44761
3/8 x 1 x 1/8		23,000 RPM	
44651	60	100	44760
44652	80	100	44760
44653	120	100	44760
44654	180	100	44760
3/8 x 1-1/2 x 1/8		23,000 RPM	
44655	60	100	44761
44656	80	100	44761
44657	120	100	44761
44658	180	100	44761

UPC	Grit	Box Qty	Use with Mandrel
Diameter x Length x Hole (Inch)			
3/8 x 2 x 1/8		23,000 RPM	
44659	60	100	44762
44660	80	100	44762
44661	120	100	44762
1/2 x 1 x 1/8		23,000 RPM	
44662	60	100	44760
44663	80	100	44760
44664	120	100	44760
44665	180	100	44760
1/2 x 1-1/2 x 1/8		23,000 RPM	
44666	40	100	44761
44667	60	100	44761
44668	80	100	44761
44669	120	100	44761
44670	180	100	44761
44671	240	100	44761
44672	320	100	44761
1/2 x 2 x 1/8		23,000 RPM	
44673	60	100	44762
44674	80	100	44762
44675	120	100	44762

UPC	Grit	Box Qty	Use with Mandrel
Diameter x Length x Hole (Inch)			
5/8 x 1-1/2 x 3/16		18,000 RPM	
44676	60	100	44765
44677	80	100	44765
44678	120	100	44765
3/4 x 1-1/2 x 1/4		18,000 RPM	
44679	60	100	44763
44680	80	100	44763
44681	120	100	44763
3/4 x 2 x 1/4		18,000 RPM	
44682	60	100	44764
44683	80	100	44764
44684	120	100	44764
1 x 1-1/2 x 1/4		15,000 RPM	
44685	60	100	44763
44686	80	100	44763
44687	120	100	44763
1 x 2 x 1/4		15,000 RPM	
44688	60	100	44764
44689	80	100	44764

Full Taper

Aluminum Oxide,
X-Weight, Closed Coat



44706

UPC	Grit	Box Qty	Use with Mandrel
Diameter x Length x Hole (Inch)			
3/8 x 1 x 1/8		23,000 RPM	
44694	60	100	44760
44695	80	100	44760
44696	120	100	44760
44697	180	100	44760
44698	240	100	44760
3/8 x 1-1/2 x 1/8		23,000 RPM	
44699	60	100	44761
44700	80	100	44761
44701	120	100	44761
44702	180	100	44761

UPC	Grit	Box Qty	Use with Mandrel
Diameter x Length x Hole (Inch)			
1/2 x 1 x 1/8		23,000 RPM	
44703	60	100	44760
44704	80	100	44760
1/2 x 1-1/2 x 1/8		23,000 RPM	
44706	60	100	44761
44707	80	100	44761
44708	120	100	44761
44709	180	100	44761

UPC	Grit	Box Qty	Use with Mandrel
Diameter x Length x Hole (Inch)			
5/8 x 1-1/2 x 1/8		18,000 RPM	
44710	60	100	44761
44711	80	100	44761
44712	120	100	44761
3/4 x 1-1/2 x 1/8		18,000 RPM	
44713	60	100	44761
44714	80	100	44761
44715	120	100	44761

Mandrels



UPC	Size	Fits Eyelet	Style	Shank Dia.	Length
Threaded Mandrel – Cross & Square Pad					
44756	1/4 x 2-1/2	PA-3-48	PM-348-2	1/4	3
44757	1/4 x 3	PA-8-32	PM-832	1/4	3
44758	1/4 x 4	PA-1/4-20	PM-1420-4	1/4	3

UPC	Style	Pilot Dia.	Pilot Length	Shank Dia.	Shank Length
Mandrel – Cartridge Rolls					
44759	CR1	5/64	1	1/8	1
44760	CR4	1/8	3/4	1/8	1
44761	CR6	1/8	1	1/8	1
44762	CR6	1/8	1-1/2	1/8	1
44763	CR21	1/4	1	1/4	1-1/4
44764	CR22	1/4	1-1/2	1/4	1-1/4
44765	CR13	3/16	3/4	1/8	1



WIRE BRUSHES

Knot Wire Wheel Brushes – USA Made

BETTER



- Wire brushes made from oil tempered wire.



Knot Wire Wheel Brush – Standard

- Standard wire twist knot design for aggressive, yet uniform brushing action.
- For surface preparation, weld cleaning, heavy duty applications, general cleaning, weld cleaning, removal of rubber flash, scale, rust, and pipeline cleaning.



Knot Wire Wheel Brush – Stringer Bead

- Tightly twisted wire knots easily reach into narrow or recessed areas for quick material removal.
- For pipeline welding junctions, cleaning bead welds.



Knot Wire Wheel Brush – Cable Twist

- Sharp wire tip for aggressive action.

UPC	Size	Type	Wire Size	Arbor Size	Face Width	Trim Length	RPM	Box Qty	Master
Knot Wire Wheel Brush – Standard Twist									
60001	4"	Carbon	.014	5/8-11	1/2"	13/16"	20,000	6	24
60006	4"	Stainless	.014	5/8-11	1/2"	13/16"	20,000	6	24
60011	4"	Stainless	.020	5/8-11	1/2"	13/16"	20,000	6	24
60012	4"	Carbon	.020	5/8-11	1/2"	7/8"	20,000	6	24
60013	5"	Carbon	.020	5/8-11	1/2"	1"	12,000	6	24
60014	5"	Stainless	.020	5/8-11	1/2"	1"	12,000	6	24
60052	6"	Carbon	.020	5/8-11	1/2"	1 1/2"	9,000	6	24
60053	6"	Carbon	.025	5/8-11	1/2"	1 1/2"	9,000	6	24
Knot Wire Wheel Brush – Stringer Bead									
60020	4"	Carbon	.020	5/8-11	1/4"	13/16"	20,000	6	24
60025	4"	Stainless	.020	5/8-11	1/4"	13/16"	20,000	6	24
60035	5"	Carbon	.020	5/8-11	1/4"	1"	12,000	6	24
60037	5"	Stainless	.020	5/8-11	1/4"	1"	12,000	6	24
60040	6-1/2"	Carbon	.020	5/8-11	1/4"	1 1/4"	12,000	6	24
60041	6-1/2"	Stainless	.020	5/8-11	1/4"	1 1/4"	12,000	6	24

Knot Wire Wheel Brushes – Fast Cut

GOOD

UPC	Size	Type	Wire Size	Arbor Size	Face Width	Trim Length	RPM	Box Qty	Master
Knot Wire Wheel Brush – Standard Twist									
60500	3"	Carbon	.014	1/2	1/2"	4/7"	20,000	5	100
60501	3"	Stainless	.014	1/2	1/2"	4/7"	20,000	5	100
60502	4"	Carbon	.020	5/8-11	1/2"	7/8"	20,000	5	100
60503	5"	Carbon	.020	5/8-11	1/2"	1"	12,500	5	100
60505	6"	Carbon	.020	5/8-11	1/2"	1 3/8"	9,000	5	25
Knot Wire Wheel Brush – Cable Twist									
60514	4"	Carbon	.020	5/8-11	1/2"	7/8"	20,000	5	50
60515	4"	Stainless	.020	5/8-11	1/2"	7/8"	20,000	5	50
Knot Wire Wheel Brush – Stringer Bead									
60520	4"	Carbon	.020	5/8-11	1/4"	7/8"	20,000	5	50
60521	4"	Stainless	.020	5/8-11	1/4"	7/8"	20,000	5	50
60522	5"	Carbon	.020	5/8-11	1/4"	7/8"	11,000	5	40
60523	6"	Carbon	.020	5/8-11	1/4"	1 1/4"	12,000	5	25
60524	6"	Stainless	.020	5/8-11	1/4"	1 1/4"	12,000	5	25
60525	6-1/2"	Carbon	.020	5/8-11	1/4"	1 1/2"	12,000	5	25

All fast cut single pack brushes sold in convenient clam shell packaging.

Wire Cup Brushes – USA Made

BETTER

- Wire brushes made from oil tempered wire.

Knot Wire Cup Brush

- Wire twist knot for high productivity and long life.
- For scale removal, deburring, weld cleaning and flat surfaces.
- For general cleaning and cleaning of corners and flat or curved work pieces.



Crimped Knot Wire Cup Brush

- Knot wire cup brushes are designed for rigorous work pieces.
- For metal surface preparation, cleaning, removal of weld scale and rust.
- Removing scale, deburring, cleaning welds or flat surfaces, heavy duty application burr removal.

UPC	Size	Type	Wire Size	Arbor Size	Face Width	Trim Length	RPM	Box Qty	Master
Wire Cup Brush – Knot									
60060	2-3/4"	Carbon	.014	5/8-11	2-3/4"	1"	14,000	6	24
60065	2-3/4"	Stainless	.014	5/8-11	2-3/4"	1"	14,000	6	24
60070	2-3/4"	Carbon	.020	5/8-11	2-3/4"	1"	14,000	6	24
60076	2-3/4"	Stainless	.020	5/8-11	2-3/4"	1"	14,000	6	48
60090	3-1/2"	Carbon	.020	5/8-11	3-1/2"	1 3/8"	12,500	1	24
60091	3-1/2"	Stainless	.020	5/8-11	3-1/2"	1 3/8"	12,500	1	24
60104	4"	Carbon	.020	5/8-11	4"	1 1/4"	6,600	1	24
60105	4"	Stainless	.020	5/8-11	4"	1 1/4"	6,600	1	24
60106	6"	Carbon	.020	5/8-11	6"	1 3/4"	6,600	1	24
60100	6"	Carbon	.035	5/8-11	6"	1 3/4"	6,600	1	24
60103	6"	Carbon	.035	5/8-11	6"	1 3/4"	6,600	1	24
Wire Cup Brush – Crimped									
60120	2-3/4"	Carbon	.014	5/8-11	2-3/4"	7/8"	14,000	6	24
60125	2-3/4"	Stainless	.014	5/8-11	2-3/4"	7/8"	14,000	6	24
60110	4"	Carbon	.020	5/8-11	4"	1 1/8"	9,000	1	24
60112	6"	Carbon	.020	5/8-11	6"	1 1/2"	6,600	1	24

Wire Cup Brushes – Fast Cut

GOOD

UPC	Size	Type	Wire Size	Arbor Size	Face Width	Trim Length	RPM	Box Qty	Master
Wire Cup Brush – Knot									
60535	2-3/4"	Carbon	.014	5/8-11	2-3/4"	1"	12,500	5	50
60536	2-3/4"	Stainless	.014	5/8-11	2-3/4"	1"	12,500	5	50
60537	2-3/4"	Carbon	.020	5/8-11	2-3/4"	1"	12,500	5	50
60538	2-3/4"	Stainless	.020	5/8-11	2-3/4"	1"	12,500	5	50
60539	4"	Carbon	.020	5/8-11	4"	1 1/4"	8,500	5	30
60540	4"	Stainless	.020	5/8-11	4"	1 1/4"	8,500	5	30
60541	6"	Carbon	.020	5/8-11	6"	1 3/4"	6,500	5	20
60542	6"	Stainless	.020	5/8-11	6"	1 3/4"	6,500	5	20
Wire Cup Brush – Crimped									
60560	3"	Carbon	.012	5/8-11	3"	7/8"	12,500	5	50
60561	3"	Stainless	.012	5/8-11	3"	7/8"	12,500	5	50
60562	4"	Carbon	.014	5/8-11	4"	1 1/8"	8,500	5	30
60563	4"	Stainless	.014	5/8-11	4"	1 1/8"	8,500	5	30
60564	6"	Carbon	.020	5/8-11	6"	1 1/2"	6,500	5	20

All fast cut single pack brushes sold in convenient clam shell packaging.

End Brushes – USA Made

BETTER



- Wire brushes made from oil tempered wire.
- Designed for tight work spaces and higher brushing speeds (up to 22,000 RPM).

Knot Wire End Brush

- For pipeline cleaning, CNC equipment maintenance/cleaning, removal of rust or scale.

UPC	Size	Type	Wire Size	Shank Size	Face Width	Trim Length	RPM	Box Qty	Master
Wire End Brush – Knot									
60130	3/4"	Carbon	.014	1/4"	3/4"	1 1/8"	22,000	12	144
60131	1"	Carbon	.020	1/4"	1"	1"	22,000	12	144
60132	1"	Stainless	.020	1/4"	1"	1"	22,000	12	144
Wire End Brush – Crimped									
60140	3/4"	Carbon	.014	1/4"	3/4"	1"	22,000	12	144
60141	1"	Carbon	.020	1/4"	1"	1"	22,000	12	144

Crimped Wire End Brush

- For general use including blending, cleaning, and polishing.

End Brushes – Fast Cut

GOOD

UPC	Size	Type	Wire Size	Shank Size	Face Width	Trim Length	RPM	Box Qty	Master
Wire End Brush – Knot									
60575	3/4"	Carbon	.014	1/4"	3/4"	1 1/8"	20,000	5	200
60576	3/4"	Carbon	.020	1/4"	3/4"	1 1/8"	20,000	5	200
60577	3/4"	Stainless	.014	1/4"	3/4"	1 1/8"	20,000	5	200
60578	1"	Carbon	.014	1/4"	1"	1"	20,000	5	200
60579	1"	Stainless	.014	1/4"	1"	1"	20,000	5	200
60580	1"	Carbon	.020	1/4"	1"	1"	20,000	5	200
Wire End Brush – Crimped									
60590	3/4"	Carbon	.014	1/4"	3/4"	1"	20,000	5	200
60591	3/4"	Stainless	.014	1/4"	3/4"	1"	20,000	5	200
60592	1"	Carbon	.014	1/4"	1"	1"	20,000	5	200
60593	1"	Stainless	.012	1/4"	1"	1"	20,000	5	200

All fast cut single pack brushes sold in convenient clam shell packaging.



Crimped Wire Wheel Brushes – USA Made

BETTER

- Wire brushes made from oil tempered wire.



Crimped Concave Wire Wheel Brush with Shank

- Uniform brush design for use on drill presses or offhand for internal and external cleaning and deburring.
- For removal of rust, scale paint and weld splatter.

Crimped Wire Wheel Brush with Shank

- Uniform brush design for use on drill presses or offhand for internal and external cleaning and deburring.
- For removal of rust, scale paint and weld splatter.

Crimped Wire Narrow Face Wheel Brush

- Flexible design can easily be paired to work on wide surfaces.
- For deburring narrow work pieces and paint and rust removal.

Crimped Wire Medium Face Wheel Brush

- For edge blending, deburring, rust removal, surface finishing.

Crimped Wire Wide Face Wheel Brush

- For deburring, rust removal, surface finishing.

Crimped Wire Wheel Brush

- Light duty brushing.

UPC	Size	Type	Wire Size	Shank/Arbor Size	Face Width	Trim Length	RPM	Box Qty	Master
Crimped Wire Wheel Brush – Concave with Shank									
60160	1-1/2"	Carbon	.012	1/4"	1/4"	1"	20,000	10	
60161	2-1/2"	Carbon	.014	1/4"	1/4"	2/3"	20,000	10	
60162	3"	Carbon	.014	1/4"	1/4"	1"	20,000	10	
Crimped Wire Wheel Brush – with Shank									
60170	2"	Carbon	.014	1/4"	1/4"	1/2"	25,000	10	
60171	3"	Carbon	.014	1/4"	1/4"	1"	25,000	10	
60172	3"	Stainless	.014	1/4"	1/4"	1"	25,000	10	
Crimped Wire Wheel Brush – High Speed									
60150	4"	Carbon	.014	5/8-11	2/7"	5/6"	15,000	6	24
Crimped Wire Wheel Brush – Narrow Face									
60180	8"	Carbon	.014	1-1/4	1/4"	1 1/2"	4,500	1	12
60181	6"	Carbon	.008	1/2-5/8	1/4"	1 1/8"	6,000	1	36
60182	6"	Carbon	.014	1/2-5/8	1/4"	1 1/8"	6,000	1	36
Crimped Wire Wheel Brush – Medium Face									
60190	3/4"	Carbon	.014	1/4"	1/3"	1"	6,000	1	36
Crimped Wire Wheel Brush – Wide Face									
60195	7"	Carbon	.014	5/8"	1/2"	1 5/9"	6,000	1	12
60196	10"	Carbon	.014	5/8"	1/2"	2"	3,600	1	6

Crimped Wire Wheel Brushes – Fast Cut

GOOD

All fast cut single pack brushes sold in convenient clam shell packaging.

UPC	Size	Type	Wire Size	Shank/Arbor Size	Face Width	Trim Length	RPM	Box Qty	Master
Crimped Wire Wheel Brush – High Speed									
60650	4"	Carbon	.014	5/8-11	2/7"	5/6"	15,000	5	50
60651	4"	Stainless	.014	5/8-11	2/7"	5/6"	15,000	5	50
Crimped Wire Wheel Brush – Medium Face									
60665	6"	Carbon	.014	5/8	1/4"	1 1/8"	6,000	5	25

Hand Brushes

- **Metal Chip Brush**
 - For hot metal removal



UPC	Description	Box Qty	Master Pack
Metal Chip Brush			
60200	1" Metal Chip Brush	12	

Scratch Brushes

- Designed with kiln-dried hardwood handles for maximum tuft retention and high-quality, staple set wire for long life.



UPC	Spec	Description	Box Qty	Master Pack
Economy Curved Handle Scratch Brush – w/hang up hole				
60201	3 x 19 Rows		12	144
60202	3 x 19 Rows	Stainless	12	144
60203	4 x 19 Rows		12	144
60204	3 x 19 Rows	with Scraper	12	144
Economy Shoe Handle Scratch Brush				
60205	4 x 16 Rows		12	72
60206	4 x 16 Rows	with Scraper	12	72
60207	4 x 16 Rows	Stainless	12	72

UPC	Spec	Description	Box Qty	Master Pack
Economy Small Cleaning Scratch Brush				
60208	3 x 7 Rows	Brass, Plastic Handle	36	648
60209	3 x 7 Rows	Stainless, Plastic Handle	36	648
Small Cleaning Scratch Brush				
60210	3 x 7 Rows	Brass	36	648
60211	3 x 7 Rows	SS Scratch Brush	36	648

Chip / Paint Brushes

UPC	Spec	Box Qty	Master Pack
60225	1/2" Pure Bristle Wood Handle Chip Paint Brush	36	72
60226	1" Pure Bristle Wood Handle Chip Paint Brush	36	72
60227	1-1/2" Pure Bristle Wood Handle Chip Paint Brush	36	72
60228	2" Pure Bristle Wood Handle Chip Paint Brush	24	72
60229	3" Pure Bristle Wood Handle Chip Paint Brush	12	72
60230	4" Pure Bristle Wood Handle Chip Paint Brush	12	48



Bulk Wire Wheel Brushes

- Quality performance and competitively priced wire wheel brushes in convenient bulk packs.
- Environmentally friendly packaging.
- Lower pricing than individual pack.
- High quality oil-tempered wire.



Bulk Knot Wire Wheel Brush – Standard Twist

- For aggressive yet, uniform brushing action.
- Designed for surface preparation, weld cleaning, removal of rubber flash, scale, rust, pipeline cleaning, and heavy duty applications.

UPC	Spec	Wire Size	Arbor Hole	Max RPM	Box Qty		Indiv. UPC	Page#
49635	4" Radial Knot Carbon Standard	.020	5/8-11	20,000	10	<i>Fast-Cut</i>	60502	62
49636	4" Radial Knot Stainless Standard	.020	5/8-11	20,000	10	<i>Fast-Cut</i>		

Bulk Knot Wire Wheel Brush – Cable Twist Wheel Brush

UPC	Spec	Wire Size	Arbor Hole	Max RPM	Box Qty		Indiv. UPC	Page#
49637	4" Radial Knot Carbon Cable Twist	.020	5/8-11	20,000	10	<i>Fast-Cut</i>	60514	63
49638	4" Radial Knot Stainless Steel	.020	5/8-11	20,000	10	<i>Fast-Cut</i>	60515	63

Bulk Knot Wire Wheel Brush – Stringer Bead

- Easily reaches into narrow or recessed areas for quick material removal. For pipeline welding junctions and cleaning bead welds.

UPC	Spec	Wire Size	Arbor Hole	Max RPM	Box Qty		Indiv. UPC	Page#
49639	4" Radial Knot Carbon Stringer Bead	.020	5/8-11	20,000	10	<i>Fast-Cut</i>	60520	62
49640	4" Radial Knot Stainless Steel Stringer	.020	5/8-11	20,000	10	<i>Fast-Cut</i>	60521	62
49641	6" Stringer Bead Carbon	.020	5/8-11	12,000	10	<i>Fast-Cut</i>	60523	62

Bulk Crimped Wire Wheel Brush

- For general use including cleaning and rust removal.

UPC	Spec	Wire Size	Arbor Hole	Max RPM	Box Qty		Indiv. UPC	Page#
49642	4" Radial Crimp Carbon	.014	5/8-11	15,000	10	<i>Fast-Cut</i>	60650	65

Bulk Knot Wire Cup Brush

- For scale removal, deburring, weld cleaning and flat surfaces.

UPC	Spec	Wire Size	Arbor Hole	Max RPM	Box Qty		Indiv. UPC	Page#
49645	2-3/4" Cup Knot Carbon	.014	5/8-11	12,500	10	<i>Fast-Cut</i>	60535	63
49646	2-3/4" Cup Knot Carbon	.020	5/8-11	12,500	10	<i>Fast-Cut</i>	60537	63
49647	4" Cup Knot Carbon 1 Row	.020	5/8-11	8,500	10	<i>Fast-Cut</i>	60539	63

Bulk Knot End Brush with 1/4" Shank

- Can be used at higher brushing speeds. For pipeline cleaning, CNC equipment maintenance/cleaning and removal of rust or scale.

UPC	Spec	Wire Size	Arbor Hole	Max RPM	Box Qty		Indiv. UPC	Page#
49649	3/4" Knotted End Brush Carbon with 1/4" Shank	.014	1/4" Shank	20,000	20	<i>Fast-Cut</i>	60575	64
60133	1" Knotted End Brush Carbon with 1/4" Shank	.006	1/4" Shank	22,000	12	Made In USA 	60131	64
49650	1" Knotted End Brush Carbon with 1/4" Shank	.020	1/4" Shank	20,000	20	<i>Fast-Cut</i>	60580	64

Bulk Crimped End Brush with 1/4" shank

UPC	Spec	Wire Size	Arbor Hole	Max RPM	Box Qty		Indiv. UPC	Page#
60250	3/4" Crimped End Brush Carbon with 1/4" Shank	.010	1/4" Shank	22,000	100	Made In USA 	60140	64

Bulk Crimped Wire Wheel Brush with 1/4" Shank

UPC	Spec	Wire Size	Arbor Hole	Max RPM	Box Qty			
49643	2" Crimped Carbon Wire with 1/4" Shank	.014	1/4" Shank	25,000	20	<i>Fast-Cut</i>		
49644	3" Crimped Carbon Wire with 1/4" Shank	.014	1/4" Shank	25,000	20	<i>Fast-Cut</i>		



Carbide Burs

- CGW carbide burs are made on premium CNC machines for precision, uniform burs.
- **Single Cut:** General purpose cut made for steel, cast iron and other ferrous materials. Single cut burs provide good material removal and work piece finishes.
- **Double Cut:** Designed to produce smaller chips for faster cutting action, minimal loading and improved operator control. For stainless steel and ferrous materials.
- **Aluminum Cut:** Wide flute design ensures quick, easy stock removal with minimal loading. For non-ferrous and other soft materials.

D_1 = head diameter
 L_1 = length of cut
 D_2 = shank diameter
 L_2 = overall length
 V = angle

SA – Cylinder Shape

- Application: **Deburring**
- No cut on end

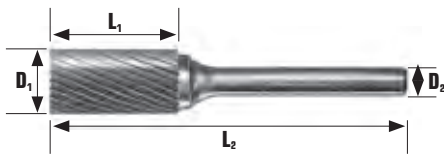

Shape	Head Diameter	Length of Cut	Shank Diameter	Overall Length	Order Qty	UPC Single	UPC Double	UPC Aluminum
SA-1	1/4"	5/8"	1/4"	2"	1		62319	
SA-3	3/8"	3/4"	1/4"	2-1/2"	1		62323	
SA-3NF	3/8"	3/4"	1/4"	2-1/2"	1			62604
SA-5	1/2"	1"	1/4"	2-3/4"	1	62028	62328	
SA-5NF	1/2"	1"	1/4"	2-3/4"	1			62608
SA-6	5/8"	1"	1/4"	2-3/4"	1		62330	
SA-7	3/4"	1"	1/4"	2-3/4"	1		62333	
Long Shank								
SA-1L6	1/4"	1/2"	1/4"	6-1/2"	1		62321	
SA-3L6	3/8"	3/4"	1/4"	6-3/4"	1		62325	
SA-5L6	1/2"	1"	1/4"	7"	1		62329	

SB – Cylinder Shape

- Applications: **Face & Peripheral Milling**
- With end cut

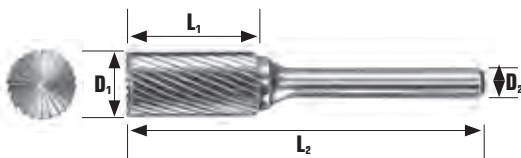

Shape	Head Diameter	Length of Cut	Shank Diameter	Overall Length	Order Qty	UPC Double	UPC Aluminum
SB-1	1/4"	5/8"	1/4"	2"	1	62350	
SB-3	3/8"	3/4"	1/4"	2-1/2"	1	62353	
SB-3NF	3/8"	3/4"	1/4"	2-1/2"	1		62613
SB-5	1/2"	1"	1/4"	2-3/4"	1	62357	
SB-5NF	1/2"	1"	1/4"	2-3/4"	1		62614

SC – Cylinder Shape

- Applications: **Surface Milling, Contouring**
- Ball nose/radius end

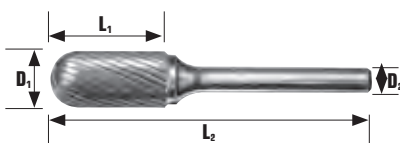

Shape	Head Diameter	Length of Cut	Shank Diameter	Overall Length	Order Qty	UPC Double	UPC Aluminum
SC-1	1/4"	5/8"	1/4"	2"	1	62377	
SC-3	3/8"	3/4"	1/4"	2-1/2"	1	62381	
SC-3NF	3/8"	3/4"	1/4"	2-1/2"	1		62621
SC-5	1/2"	1"	1/4"	2-3/4"	1	62386	
SC-5NF	1/2"	1"	1/4"	2-3/4"	1		62625
SC-7	3/4"	1"	1/4"	2-3/4"	1	62391	
Long Shank							
SC-1L6	1/4"	1/2"	1/4"	6-1/2"	1	62379	
SC-3L6	3/8"	3/4"	1/4"	6-3/4"	1	62383	
SC-5L6	1/2"	1"	1/4"	7"	1	62387	

SD – Ball Shape

- Applications:
Deburring, Contouring,
Build-up Welding Preparation

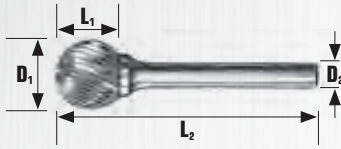

SE – Oval/Egg Shape

- Application: Contouring

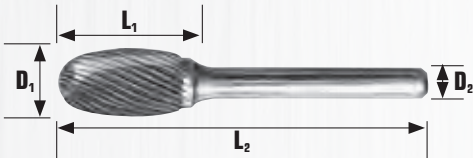

SF – Rounded Tree Shape

- Application: Contouring

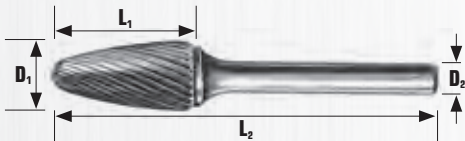

SG – Pointed Tree Shape

- Applications:
Sharp angled areas, narrow contours

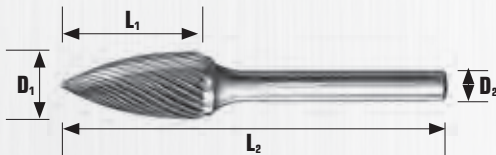

SH – Flame Shape

- Application: Contouring

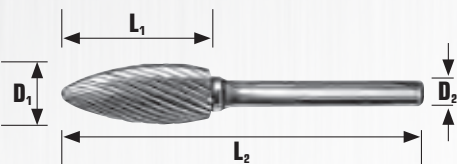

Shape	Head Diameter	Length of Cut	Shank Diameter	Overall Length	Order Qty	UPC Double
SD-1	1/4"	7/32"	1/4"	2"	1	62404
SD-3	3/8"	5/16"	1/4"	2-5/64"	1	62407
SD-5	1/2"	7/16"	1/4"	2-13/64"	1	62410
SD-6	5/8"	9/16"	1/4"	2-5/16"	1	62412
SD-7	3/4"	11/16"	1/4"	2-7/16"	1	62413

Long Shank

SD-3L6	3/8"	3/8"	1/4"	6-3/8"	1	62408
--------	------	------	------	--------	---	-------

Shape	Head Diameter	Length of Cut	Shank Diameter	Overall Length	Order Qty	UPC Double
SE-3	3/8"	5/8"	1/4"	2-3/8"	1	62425
SE-5	1/2"	7/8"	1/4"	2-5/8"	1	62427
SE-7	3/4"	1"	1/4"	2-3/4"	1	62430

Long Shank

SE-3L6	3/8"	5/8"	1/4"	6-5/8"	1	62426
SE-5L6	1/2"	7/8"	1/4"	6-7/8"	1	62428

Shape	Head Diameter	Length of Cut	Shank Diameter	Overall Length	Order Qty	UPC Single	UPC Double	UPC Aluminum
SF-1	1/4"	5/8"	1/4"	2"	1		62440	
SF-3	3/8"	3/4"	1/4"	2-1/2"	1	62142	62442	
SF-3NF	3/8"	3/4"	1/4"	2-1/2"	1			62654
SF-5	1/2"	1"	1/4"	2-3/4"	1	62146	62446	
SF-5NF	1/2"	1"	1/4"	2-3/4"	1			62658
SF-6	5/8"	1"	1/4"	2-3/4"	1		62448	
SF-7	3/4"	1"	1/4"	2-3/4"	1		62449	

Long Shank

SF-3L6	3/8"	3/4"	1/4"	6-3/4"	1		62443	
SF-5L6	1/2"	1"	1/4"	7"	1		62447	

Shape	Head Diameter	Length of Cut	Shank Diameter	Overall Length	Order Qty	UPC Single	UPC Double
SG-51	1/4"	1/2"	1/8"	2"	1	62161	
SG-1	1/4"	5/8"	1/4"	2"	1		62462
SG-3	3/8"	3/4"	1/4"	2-1/2"	1		62465
SG-5	1/2"	1"	1/4"	2-3/4"	1		62468

Long Shank

SG-1L6	1/4"	1/2"	1/4"	6-1/2"	1		62463
SG-5L6	1/2"	1"	1/4"	7"	1		62469

Shape	Head Diameter	Length of Cut	Shank Diameter	Overall Length	Order Qty	UPC Double
SH-2	5/16"	3/4"	1/4"	2-1/2"	1	62478
SH-5	1/2"	1-1/4"	1/4"	3"	1	62480

Long Shank

SH-2L6	5/16"	3/4"	1/4"	6-3/4"	1	62479
--------	-------	------	------	--------	---	-------

SL – Taper Shape Radius

- Applications:
Narrow contours, surface machining

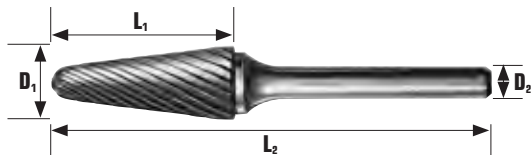

Shape	Head Diameter	Length of Cut	Shank Diameter	Overall Length	Order Qty	UPC Double	UPC Aluminum
SL-4	1/2"	1-1/8"	1/4"	3"	1	62502	
SL-1	1/4"	5/8"	1/4"	2"	1	62505	
SL-3	3/8"	1-1/16"	1/4"	2-5/16"	1	62508	
SL-4NF	1/2"	1-1/8"	1/4"	3"	1		62668
SL-5	5/8"	1-3/16"	1/4"	3-1/16"	1	62511	
Long Shank							
SL-3L6	3/8"	1-1/16"	1/4"	7-1/16"	1	62509	
SL-4L6	1/2"	1-1/8"	1/4"	7-1/8"	1	62510	

SM – Pointed Cone Shape

- Application:
Narrow contours, surface machining
- Pointed end



Shape	Head Diameter	Length of Cut	Shank Diameter	Overall Length	Order Qty	UPC Single	UPC Double
SM-1	1/4"	1/2"	1/4"	2"	1		62522
SM-3	1/4"	1"	1/4"	2"	1		62524
SM-5	1/2"	7/8"	1/4"	2-3/4"	1	62226	62526

D_1 = head diameter
 L_1 = length of cut
 D_2 = shank diameter
 L_2 = overall length
 V = angle

Carbide Bur Kit

**USA
MADE**



Carbide burs or rotary files are made in a variety of shapes and types, and are used for deburring, drilling, milling, and finishing numerous shapes and materials, including aluminium, copper, plastic, stainless steel, iron, castings, and titanium. For use on hand-held pneumatic and electric die grinders.

- 8-Piece kit has the most popular double cut carbide burs for faster cutting action, minimal loading and improved operator control.

8-Piece kit includes:

SA-5D (#62328), SC-5D (#62386),
 SD-5D (#62410), SE-5D (#62477),
 SG-5D (#62468), SH-5D (#62480),
 SL-5D (#62511), SM-5D (#62526)



CARBIDE BUR KIT	UPC
8 piece set	62700

Cotton Fiber Wheels – Blending

- General Fabrication, Tank Fabrication (Pharmaceutical, Petro-Chemical, Dairy), Shipbuilding, Food Service.
- Grind and finish with one wheel for long working life.

A36GFX UPC	A54GFX UPC	Size	RPM	Box Qty
49549	49600	4-1/2 x 1/4 x 7/8	13,300	25
49550		4-1/2 x 1/4 x 5/8-11	13,300	10
49551		5 x 1/4 x 7/8	12,200	25
49553		7 x 1/4 x 7/8	8,500	25

Type 27



- Cotton fiber impregnated with aluminum oxide grain and latex bond for superior stainless steel and aluminum blending and finishing.
- Smooth grinding action. Aluminum will not load-up.

Cotton Fiber Quick Change Discs – Roll On

- Aircraft/Aerospace, Food Service, Automotive, General Fabrication.
- No smearing on titanium and stainless steel.
- Grind and finish with one disc.
- Engineered to last 10 times longer than coated discs.



UPC	Size	RPM	Specs	Box Qty
49558	3	20,000	A36F	25
49559	3	20,000	A54F	25

- Smooth grinding action. Aluminum will not load-up.
- Flexible disc structure for specific applications.
- Ideal for light weld removal, blending, deburring and finishing.

Cotton Fiber Mounted Points

- Aircraft/Aerospace, Automotive, Tool & Die, Fabrication.
- Debur, blend and finish with one mounted point.
- Provide superior metal removal control without changing part geometry.
- Ideal for deburring and polishing stainless steel, aluminum, mild steel and exotic metals.



W163

W177

B52

UPC	Shape	Size	Shank Diameter	Shank Length	Spec	RPM	Box Qty
49561	W163	1/4 x 1/2	1/8"	1-1/2"	A80GFX	59,990	25
49563	W163	1/4 x 1/2	1/8"	1-1/2"	A120GFX	59,990	25
49564	W177	3/8 x 3/4	1/8"	1-1/2"	A80GFX	33,750	25
49566	W177	3/8 x 3/4	1/8"	1-1/2"	A120GFX	33,750	25
49567	B52	3/8 x 3/4	1/8"	1-1/2"	A80GFX	45,370	25
49569	B52	3/8 x 3/4	1/8"	1-1/2"	A120GFX	45,370	25

Cotton Fiber Deburring & Finishing Wheels

- Aluminum Oxide impregnated cotton fiber and fiberglass reinforcement (for die grinder speeds).
- Soft bond – for light deburring and finishing.
- Hard bond – for deburring and long life.

Type 1



UPC	Size	RPM	Specs	Box Qty
49576	3 x 1/8 x 1/4	20,000	ACRS-HARD	25
49577	3 x 1/8 x 1/4	20,000	AMED-SOFT	25
49578	3 x 1/8 x 1/4	20,000	AFN-SOFT	25



RESIN CONES, PLUGS & CUP WHEELS

USA
MADE

ALUMINUM OXIDE

SILICON CARBIDE

Resin Cones & Plugs

- **A:** Aluminum Oxide Grain; Used for grinding and finishing metals in hard to reach areas.

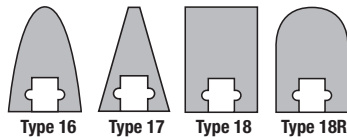

UPC	Size	Spec	Grit	RPM	Box Qty
Cones, Type 16					
49016	1-1/2 x 2-1/2 x 3/8-24	A16R	16	24,100	10
49017	1-1/2 x 2-1/2 x 5/8-11	A16R	16	24,100	10
49018	1-1/2 x 3 x 3/8-24	A16R	16	24,100	10
49019	1-1/2 x 3 x 5/8-11	A16R	16	24,100	10
36238	2 x 3 x 5/8-11	A24R	24	18,100	10
49021	2 x 3 x 5/8-11	A16R	16	18,100	10
49022	2-3/4 x 3-1/2 x 5/8-11	A16R	16	13,200	10
49023	3 x 3 x 5/8-11	A16R	16	13,200	10
Cones, Type 17					
49024	1-1/2 x 2-1/2 x 3/8-24	A16R	16	24,100	10
49026	1-1/2 x 3 x 3/8-24	A16R	16	24,100	10
49027	1-1/2 x 3 x 5/8-11	A16R	16	24,100	10
49028	2 x 3 x 5/8-11	A16R	16	18,100	10
49029	2 1/2 x 3 x 5/8-11	A16R	16	18,100	10

UPC	Size	Spec	Grit	RPM	Box Qty
Plugs, Type 18					
49030	1-1/2 x 2-1/2 x 3/8-24	A16R	16	24,100	10
49031	1-1/2 x 2-1/2 x 5/8-11	A16R	16	24,100	10
49032	1-1/2 x 3 x 3/8-24	A16R	16	24,100	10
49033	1-1/2 x 3 x 5/8-11	A16R	16	24,100	10
36239	2 x 3 x 5/8-11	A24R	24	18,100	10
49035	2 x 3 x 5/8-11	A16R	16	18,100	10
49036	2 x 3-1/2 x 5/8-11	A16R	16	18,100	10
Plugs, Type 18R					
49037	1-1/2 x 2-1/2 x 3/8-24	A16R	16	24,100	10
49038	1-1/2 x 2-1/2 x 5/8-11	A16R	16	24,100	10
49039	1-1/2 x 3 x 3/8-24	A16R	16	24,100	10
49040	1-1/2 x 3 x 5/8-11	A16R	16	24,100	10
36240	2 x 3 x 5/8-11	A24R	24	18,100	10
49042	2 x 3 x 5/8-11	A16R	16	18,100	10
49043	3 x 3 x 5/8-11	A16R	16	13,200	10

Resin Cup Wheels

- **A:** Aluminum Oxide; For tough steel applications.
- **CA:** Aluminum Oxide/Silicon Carbide Mix; Excellent for castings, cast iron, aluminum.
- **C:** Ideal for grinding and cleaning concrete, masonry and stone.

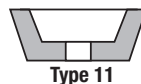

UPC	Size	Spec	Grit	RPM	Box Qty
4/3 x 2 x 5/8-11		9,070 R.P.M.			
No Steel Back					
49000	4/3 x 2 x 5/8-11	A16-Q6-B	16	9,070	1
49002	4/3 x 2 x 5/8-11	C16-N-B	16	9,070	1
49003	4/3 x 2 x 5/8-11	CA16-N-B	16	9,070	1
With Steel Back					
49001	4/3 x 2 x 5/8-11	A16-Q6-B	16	9,070	1
5/4 x 2 x 5/8-11		7,260 R.P.M.			
No Steel Back					
49004	5/4 x 2 x 5/8-11	A16-Q6-B	16	7,260	1
49005	5/4 x 2 x 5/8-11	A24-Q6-B	24	7,260	1
49006	5/4 x 2 x 5/8-11	C16-N-B	16	7,260	1
49007	5/4 x 2 x 5/8-11	CA16-N-B	16	7,260	1

UPC	Size	Spec	Grit	RPM	Box Qty
6/4-3/4 x 2 x 5/8-11		6,048 R.P.M.			
No Steel Back					
35900	6/4-3/4 x 2 x 5/8-11	A16-Q6-B	16	6,048	5
49008	6/4-3/4 x 2 x 5/8-11	A16-Q6-B	16	6,048	1
49010	6/4-3/4 x 2 x 5/8-11	A24-Q6-B	24	6,048	5
49011	6/4-3/4 x 2 x 5/8-11	A24-Q6-B	24	6,048	1
35901	6/4-3/4 x 2 x 5/8-11	C16-N-B	16	6,048	1
49014	6/4-3/4 x 2 x 5/8-11	CA16-QB-B	16	6,048	1
With Steel Back					
49009	6/4-3/4 x 2 x 5/8-11	A16-Q6-B	16	6,048	1
49012	6/4-3/4 x 2 x 5/8-11	A24-Q6-B	24	6,048	1
49013	6/4-3/4 x 2 x 5/8-11	C16-N-B	16	6,048	1
49015	6/4-3/4 x 2 x 5/8-11	CA16-Q6-B	16	6,048	1



DIAMOND WHEELS

D3-Diamond – Depressed Center Diamond

At Least 25 Times The Life Of Resin Wheels

- Longer working life - advanced brazing process and high-quality diamonds for less down time for increased production times.
- Can be used on sheet metal up to 3/8" thick or metal bar up to 3/4" thick.
- Cleaner and easier working – designed to produce fewer sparks, no odor and less material debris.
- Safer working – solid steel body. No fractures and breaks.



70401

UPC	Size	Specs	Grit	Type	Box Qty
Depressed Center Grinding Wheels					
70401	4-1/2 x 5/8-11	Notch / Cut / Grind	24	Type 29	1
70407	7 x 5/8-11	Pipeline	50	Type 27	1
Depressed Center Grinding Wheels - Finer Finish					
70449	4-1/2 x 5/8-11	Grinding	50	Type 29	1
70428	9 x 1/4 x 5/8-11	Flat Grinding	36	Type 1	1
Flat Grind (Reversible) - Foundry and Hard Facing					
49714	4-1/2 x .050 x 7/8	Thin Cutting Blade		Type 1	1
49716	6 x .050 x 7/8	Thin Cutting Blade		Type 1	1
High Speed Wheels (All Steel types - RAIL), Stationary and Chop Saw					
70456	12 x .15 x 20mm / 1	Cut Off	24	Type 1	1
70429	14 x .15 x 20mm / 1	Cut Off	24	Type 1	1
70430	16 x .15 x 1 / 20mm	Cut Off	30	Type 1	1
70432	20 x .17 x 1	Cut Off	30	Type 1	1

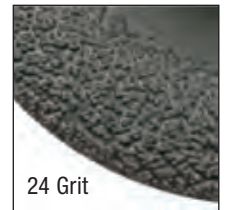

24 Grit

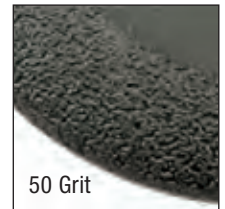

50 Grit

For Better Results:

- Do not use on metal plates/sheets over 3/8" thick.
- Do not use on solid bars/bolts over 3/4".
- Let the diamond do the cutting, do not push or force the wheel.

Applications:

- Steel, stainless steel, fiberglass, plastics, composite materials, masonry and ceramics.
- Sheet and plate work.

Demolition Blade

- Metal decking, reinforced concrete, steel, expanded metal, cast iron, ductile iron, PVC pipe and wood.
- Can be used wet or dry.



UPC	Size	Specs	RPM	Box Qty
70447	14 x .15 x 1" / 20mm	24 Grit	5,360	1

Type 1





PRECISION GRINDING VITRIFIED WHEELS



Made in Israel on state-of-the-art equipment since 1956, CGW offers precision grinding vitrified solutions for the most difficult applications. Our success is attributed to our leading manufacturing, technical and logistical support.

CGW **stocks** a comprehensive list of popular specs and sizes in our Chicago, IL distribution facility - **ships the same day!**

Made-to-order items have an industry leading 12 week standard Lead Time. CGW wheels are OSA and ANSI certified and made to the most stringent quality standards.

Selecting The Correct Wheel

Grain

Friable/Sharp: WA, WAG, PA, PASP

Med/General Purpose: AZ, BAS (91AB/94AB), RA

Hard: AS3, 32A, A

Wheel Speeds

Standard: 35m/s or 6,500sfpm

High: 45m/s or 8,500sfpm

Premium: 60m/s or 12,000sfpm

Structure

DENSE ← → **OPEN/POROUS**
3 4 5 6 7 8 9 10 11 12 18

Closed

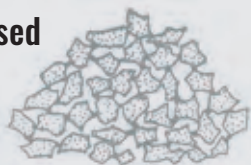

5-8 Structures

Open



10-14 Structures

Grade

Soft: B, D, E, F, G, H

Medium: I, J, K, L, M, N

Hard: O, P, Q, R, S, T

Wheel Size



MAXIMUM OPERATING SPEED

7 x 1/2 x 1 1/4 RA 46H 8V
WHEEL SIZE ABRASIVE GRAIN SIZE GRADE STRUCTURE BOND



Surface Grinding Wheel Safety Ring Test

- Always perform a ring test on a grinding wheel before mounting it. The ring test will locate an invisible crack.
- If a sharp distinct ring is heard the wheel is safe.
- If the wheel is cracked the ring will be dull. **DO NOT USE DAMAGED WHEELS.**

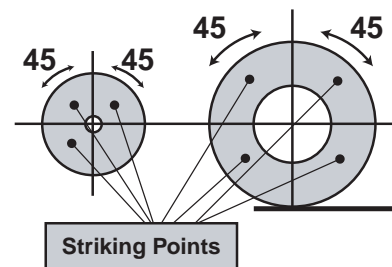

Abrasive Grain Selection Chart



AS3 – Ceramic Aluminum Oxide

BEST – High Performance with most Durability

- Engineered for fast metal removal with reduced dressing frequency.
- Excels at grinding 50 Rockwell C and harder.
- Submicron crystal structure continually fractures to produce sharp new grinding points.

32A – Mono-Crystalline Aluminum Oxide

BETTER – Versatility and Performance

- Mono-crystalline Aluminum Oxide grain offers excellent versatility and performance on a wide range of applications and materials.
- Ideal for medium to heavy stock removal.

AZ / BAS– Premium Blue Aluminum Oxide

BETTER – Combination of Sharpness and Durability



- The premium grain and bond technology makes AZ the best choice for applications that demand both sharpness and durability.
- Exceptionally fast and cool cutting characteristics suitable for grinding heat sensitive, alloy steels and mold steels (high speed steels under 58RC).
- More durable than WA and PA with superior sharpness.

PA / PASP – Pink Aluminum Oxide

GOOD – Sharpening and Grinding of Tool Steel

- Ideal for fast & cool cutting of heat sensitive & hard alloys.
- More durable than WA on tool steel & stainless at light to moderate feed rates.

WA / WAG – White Aluminum Oxide

GOOD – Light Stock Removal, General Purpose Use

- Used when easy cutting action is needed on all surfaces.
- Ideal for grinding heat-sensitive steels and medium to grind high speed steels.

A – Brown Aluminum Oxide

GENERAL PURPOSE – The choice for bench wheels

- The most common of all grains. This grain is used for heavy-duty applications.

RA – Ruby Aluminum Oxide

SPECIALTY – The choice for special material applications

- Ideal for rough grinding of all tool steels including steel with high levels of chromium.
- A tough, sharp friable abrasive with high material removal and strong form holding.

Surface Grinding Wheels

- Surface grinding is the most common of the grinding operations. Surface grinding wheels can be used for heavy stock removal to a very precise finish and size requirements. Matching the right wheel with the application is very important to achieve the needs of the grinder.
- Surface grinding is done on both planer and rotary-type machines, using either vertical and horizontal spindle design.
- Popular Markets – Machine shops, cutting tools, aerospace, food processing, automotive, mold and fixture shops.



GC – Green Silicon Carbide

- Non-Ferrous Metals
- Carbide, Granite, Ceramic and Chrome.

Surface Grinding Wheel Selection Chart



Grade	
Soft:	D, E, F, G, H
Medium:	I, J, K, L
Hard:	M, N, O, P, Q

Up to 8" size wheels – **Box Qty: 10**

10" size wheels – **Box Qty: 5**

12" size and larger – **Box Qty: 1 to 3**
please contact customer service.

Size – Grit – Hardness	AS3 Ceramic	32A MC ALOX	AZ Premium Blue	RA Ruby	PA Pink	WA White	GC Green
6"							
6 x 1/2 x 11/4 T1 60-K			34301				
7"							
7 x 1/4 x 11/4 T1 46-H12 Porous		34250		59081			
7 x 1/4 x 11/4 T1 46-I			34303			34600	
7 x 1/4 x 11/4 T1 60-I			34308			34603	34611
7 x 1/4 x 11/4 T1 60-J			34309	59025		34604	
7 x 1/4 x 11/4 T1 60-K			34310			34605	
7 x 1/4 x 11/4 T1 80-I							34612
7 x 1/4 x 11/4 T1 80-J			34312			34606	
7 x 1/4 x 11/4 T1 80-K	34207		34313		58002	34607	
7 x 1/4 x 11/4 T1 100-I							34613
7 x 1/4 x 11/4 T1 100-K			34315			34608	
7 x 1/4 x 11/4 T1 120-K						34609	
7 x 1/4 x 11/4 T1 150-K			34317			34610	
7 x 1/2 x 11/4 T1 46-H	34208	37700	34318	34633	58004	34615	
7 x 1/2 x 11/4 T1 46-I	34210	37701	34319			34616	
7 x 1/2 x 11/4 T1 46-J	34209	37702	34320	34634	58006	34617	
7 x 1/2 x 11/4 T1 46-K		37703	34321		58007	34618	
7 x 1/2 x 11/4 T1 60-H					58008	34619	
7 x 1/2 x 11/4 T1 60-I		37704	34324			34620	34627
7 x 1/2 x 11/4 T1 60-J	34212	37705	34325	34635		34621	
7 x 1/2 x 11/4 T1 60-K	34213	37706	34326		58011	34622	
7 x 1/2 x 11/4 T1 60-L							
7 x 1/2 x 11/4 T1 80-H			34328				
7 x 1/2 x 11/4 T1 80-I							34628
7 x 1/2 x 11/4 T1 80-K	37768	37728	34329	59000	58012	34623	

Surface Grinding Wheel Selection Chart *(Continued)*

Size – Grit – Hardness	AS3 Ceramic	32A MC ALOX	AZ Premium Blue	RA Ruby	PA Pink	WA White	GC Green
7 x 1/2 x 11/4 T1 100-I							34629
7 x 1/2 x 11/4 T1 100-K			34330			34624	
7 x 1/2 x 11/4 T1 120-K						34625	
7 x 1/2 x 11/4 T1 150-K			34332			34626	
7 x 1/2 x 11/4 T1 46-H12 Porous			34333				
7 x 3/4 x 11/4 (R/1-3 x 1/4) T5 46-H			34335			34636	
7 x 3/4 x 11/4 (R/1-3 x 1/4) T5 46-I			34336		58013		
7 x 3/4 x 11/4 (R/1-3 x 1/4) T5 46-J			34337	59001		34638	
7 x 3/4 x 11/4 (R/1-3 x 1/4) T5 60-H						34640	
7 x 3/4 x 11/4 (R/1-3 x 1/4) T5 60-I							34644
7 x 3/4 x 11/4 (R/1-3 x 1/4) T5 60-J			34341	59002		34642	
7 x 3/4 x 11/4 (R/1-3 x 1/4) T5 80-I							34645
7 x 1 x 11/4 (R/1-3 x 1/2) T5 46-H		37732	34342		58016	34647	
7 x 1 x 11/4 (R/1-3 x 1/2) T5 46-I			34343			34648	
7 x 1 x 11/4 (R/1-3 x 1/2) T5 46-J		37733	34344	59003	58017	34649	
7 x 1 x 11/4 (R/1-3 x 1/2) T5 46-K			34345				
7 x 1 x 11/4 (R/1-3 x 1/2) T5 60-I						34652	34655
7 x 1 x 11/4 (R/1-3 x 1/2) T5 60-J			34348	59004		34653	
7 x 1 x 11/4 (R/1-3 x 1/2) T5 60-K			34349				
7 x 1 x 11/4 (R/1-3 x 1/2) T5 80-I							34656
7 x 1 x 11/4 (R/1-3 x 1/2) T5 100-I							34657
8"							
8 x 1/4 x 11/4 T1 60-J	34114						
8 x 1/4 x 11/4 T1 60-K						34663	
8 x 1/4 x 11/4 T1 80-I							34669
8 x 1/4 x 11/4 T1 80-J						34664	
8 x 1/2 x 11/4 T1 46-H		37707	34350	59005	58019	34671	
8 x 1/2 x 11/4 T1 46-I		37708	34351			34672	
8 x 1/2 x 11/4 T1 46-J	37771	37709	34352	59006	58021	34673	
8 x 1/2 x 11/4 T1 46-G12 Porous	34252						
8 x 1/2 x 11/4 T1 46-H12 Porous				59084			
8 x 1/2 x 11/4 T1 46-K	34214		34353			34674	
8 x 1/2 x 11/4 T1 60-H			34354				
8 x 1/2 x 11/4 T1 60-I							34680
8 x 1/2 x 11/4 T1 60-H12 Porous	34254			59085			
8 x 1/2 x 11/4 T1 60-I			34355			34676	
8 x 1/2 x 11/4 T1 60-J	34215	37710	34356		58023	34677	
8 x 1/2 x 11/4 T1 60-K			34357	59007		34678	
8 x 1/2 x 11/4 T1 80-I							34681
8 x 1/2 x 11/4 T1 80-K		37736	34358	59008	58025	34679	
8 x 1/2 x 11/4 T1 100-I							34682
8 x 3/4 x 11/4 (R/1-3 x 1/4) T5 46-H			34359	59009	58026	34683	
8 x 3/4 x 11/4 (R/1-3 x 1/4) T5 46-J			34360			34685	
8 x 3/4 x 11/4 (R/1-3 x 1/4) T5 60-I						34688	34692
8 x 3/4 x 11/4 (R/1-3 x 1/4) T5 60-J			34364	59033		34689	
8 x 3/4 x 11/4 (R/1-3 x 1/4) T5 60-K						34690	
8 x 1 x 11/4 (R/1-3 x 1/2) T5 46-H			34366				
8 x 1 x 11/4 (R/1-3 x 1/2) T5 46-J			34367	59010	58028	34697	
8 x 1 x 11/4 (R/1-3 x 1/2) T5 46-K						34698	
8 x 1 x 11/4 (R/1-3 x 1/2) T5 60-I						34700	34703
8 x 1 x 11/4 (R/1-3 x 1/2) T5 60-J			34369	59011	58029	34701	
8 x 1 x 11/4 (R/1-3 x 1/2) T5 60-K						34702	
8 x 1 x 11/4 (R/1-3 x 1/2) T5 100-I							34705

Surface Grinding Wheel Selection Chart *(Continued)*

Size – Grit – Hardness	AS3 Ceramic	32A MC ALOX	AZ Premium Blue	RA Ruby	PA Pink	WA White	GC Green
10"							
10 x 3/4 x 3 T1 60-H			34383				
10 x 1 x 2 T1 46-I			34387				
10 x 1 x 3 T1 46-I			34390				
10 x 1 x 3 T1 46-J	37773	37737	34391	59012	58031	34725	
10 x 1 x 3 T1 46-K	34217		34392				
10 x 1 x 3 T1 60-J		37738	34395	59035		34729	
10 x 1 x 3 T1 60-K			34396				
12"							
12 x 1 x 3 T1 46-H	34219	37712	34411	59013	58033	34742	
12 x 1 x 3 T1 46-I							
12 x 1 x 3 T1 46-J	34220		34413		58034	34744	
12 x 1 x 3 T1 46-J/K				59014			
12 x 1 x 3 T1 46-K			34414				
12 x 1 x 3 T1 60-I	34221						
12 x 1 x 3 T1 60-K		37739	34418				
12 x 1 x 5 T1 46-H	34222		34419			34752	
12 x 1 x 5 T1 46-J	34223	37740	34421	59038		34755	
12 x 1 x 5 T1 46-K			34422	59015			
12 x 1 x 5 T1 60-J		37742	34425			34759	
12 x 1 x 5 T1 60-K			34426	59016			
12 x 1 x 5 T1 80-K		37754					
12 x 11/2 x 3 (R/1-71/2 x 1/2) T5 46-H						34761	
12 x 11/2 x 3 (R/1-71/2 x 1/2) T5 46-I						34762	
12 x 11/2 x 3 (w-71/2 x 1/2) T5 46-J						34763	
12 x 11/2 x 3 (R/1-71/2 x 1/2) T5 60-I						34766	
12 x 11/2 x 5 (R/1-71/2 x 1/2) T5 46-H	34225	37714	34427	59017	58037	34769	
12 x 11/2 x 5 (R/1-71/2 x 1/2) T5 46-I						34770	
12 x 11/2 x 5 (R/1-71/2 x 1/2) T5 46-J	34226	37715	34429	59018	58038	34771	
12 x 11/2 x 5 (R/1-71/2 x 1/2) T5 46-K			34430				
12 x 11/2 x 5 (R/1-71/2 x 1/2) T5 60-I						34774	
12 x 11/2 x 5 (R/1-71/2 x 1/2) T5 60-J	34227	37755	34433	59040		34775	
12 x 2 x 3 (R/2-71/2 x 1/2) T7 46-I			34434				
12 x 2 x 3 (R/2-61/2 x 1/2) T7 60-J			34435				
12 x 2 x 5 (R/2-61/2 x 1/2) T7 46-H		37716	34436		58039		
12 x 2 x 5 (R/2-71/2 x 1/2) T7 46-I		37717	34437		58040	34778	
12 x 2 x 5 (R/2-71/2 x 1/2) T7 46-J				59020		34779	
12 x 2 x 5 (R/2-71/2 x 1/2) T7 60-H			34440			34781	
14"							
14 x 1 x 3 T1 46-H	37779						
14 x 1 x 3 T1 46-I			34445				
14 x 1 x 3 T1 46-J	34115						
14 x 1 x 3 T1 60-J							
14 x 1 x 5 T1 46-H	34230	37745	34447		58048		
14 x 1 x 5 T1 46-I		37718	34448	59021	58049	34786	
14 x 1 x 5 T1 46-J	34232		34449				
14 x 1 x 5 T1 60-I			34452			34790	
14 x 1 x 5 T1 60-J	34233						
14 x 1 x 5 T1 60-K		37746	34454		58050	34792	
14 x 1 x 5 T1 80-K		37761				34830	
14 x 11/2 x 5 T1 46-H	34238	37719	34456	59022		34801	
14 x 11/2 x 5 T1 46-I		37747				34802	
14 x 11/2 x 5 T1 46-J	34239	37720	34458			34803	

Surface Grinding Wheel Selection Chart (Continued)

Size – Grit – Hardness	AS3 Ceramic	32A MC ALOX	AZ Premium Blue	RA Ruby	PA Pink	WA White	GC Green
14 x 11/2 x 5 T1 46-K			34459	59045			
14 x 11/2 x 5 T1 60-H			34460				
14 x 11/2 x 5 T1 60-I	34240						
14 x 11/2 x 5 T1 60-J			34462				
14 x 11/2 x 5 (R/1-8 x 1/2) T5 46-H	34234	37721	34464		58041	34793	
14 x 11/2 x 5 (R/1-8 x 1/2) T5 46-I	34235	37722	34465	59023		34794	
14 x 11/2 x 5 (R/1-8 x 1/2) T5 46-J	37782		34466		58042	34795	
14 x 11/2 x 5 (R/1-8 x 1/2) T5 46-K		37748	34467				
14 x 11/2 x 5 (R/1-8 x 1/2) T5 60-I			34469			34798	
14 x 11/2 x 5 (R/1-8 x 1/2) T5 60-J		37749	34470				
14 x 2 x 5 T1 46-H		37750	34472				
14 x 2 x 5 T1 46-I			34473			34808	
14 x 2 x 5 T1 46-J		37723	34474				
14 x 2 x 5 T1 60-J		37764				34809	
14 x 2 x 5 (R/1-8 x 1) T5 46-H	34241	37724	34480	59024	58043	34811	
14 x 2 x 5 (R/1-8 x 1) T5 46-I			34481		58044	34812	
14 x 2 x 5 (R/1-8 x 1) T5 46-J		37751	34482			34813	
14 x 2 x 5 (R/1-8 x 1) T5 60-I						34816	
14 x 2 x 5 (R/1-8 x 1) T5 60-J	34116		34486	59059			
14 x 2 x 5 (R/1-8 x 1) T5 60-K		37726	34487		58045		
14 x 2 x 5 (R/2-8 x 3/8) T7 46-H		37752					
14 x 2 x 5 (R/2-8 x 3/8) T7 46-I			34488		58046		
14 x 2 x 5 (R/2-8 x 3/8) T7 46-J			34489		58047		
14 x 2 x 5 (R/2-8 x 3/8) T7 46-K			34490				
14 x 2 x 5 (R/1-8 x 1) T7 60-J		37753					
16"							
16 x 11/2 x 5 T1 46-H			34491				
16 x 11/2 x 5 T1 60-J			34493				
16 x 2 x 5 T1 46-I			34495				
16 x 2 x 5 T1 46-J			34496				
16 x 2 x 5 T1 60-K			34497				

Large Surface Grinding Wheel Selection Chart

Size – Grit – Hardness	AS3 Ceramic	91AB BAS	AZ Premium Blue	PASP Pink	83A White	72C Black	WAG White
18"							
18 x 2 x 8 T7 46-I		34003					
18 x 2 x 8 T7 46-H					34004		
20"							
20 x 1 x 8 T1 46-H					34006		
20 x 1 x 8 T1 60-J					34007		
20 x 11/2 x 8 T5 46-H					34014		
20 x 2 x 8 T7 46-I		34021					
20 x 2 x 8 T7 46-H					34022		
20 x 2 x 8 T7 60-J					34023		
20 x 2 x 8 T7 46-G					34025		
20 x 2 x 10 T1 36-J					34027		
20 x 2 x 10 T1 46-H					34028		
20 x 2 x 10 T1 60-J					34029		
20 x 2 x 10 T1 46-G					34030		
20 x 3 x 8 T1 80-H							37817

Large Surface Grinding Wheel Selection Chart (Continued)

Size – Grit – Hardness	AS3 Ceramic	91AB BAS	AZ Premium Blue	PASP Pink	83A White	72C Black	WAG White
20 x 3 x 8 T1 60-K				37818			
20 x 3 x 8 T7 46-I		34032	34034			34038	
20 x 3 x 8 T7 46-H					34033		
20 x 3 x 8 T7 60-J					34048		
20 x 3 x 8 T7 36-J/K					34035		
20 x 3 x 8 T7 46-D					34036		
20 x 3 x 8 T7 46-G					34037		
20 x 3 x 10 T7 46-I		34039	34043			34049	
20 x 3 x 10 T7 46-H	34245				34040		
20 x 3 x 10 T7 60-J					34041		
20 x 3 x 10 T7 36-J/K					34044		
20 x 3 x 10 T7 46-G					34046		
20 x 4 x 8 T7 46-H					34051		
20 x 4 x 10 T7 46-I		34055					
20 x 4 x 10 T7 46-H					34057		
20 x 4 x 10 T7 46-D					34059		
20 x 4 x 10 T7 46-G					34060		
20 x 6 x 10 T7 46-I		34063					
20 x 6 x 10 T7 46-H	34067				34064		
20 x 6 x 10 T7 36-J/K					34069		
20 x 6 x 10 T7 46-B					34070		
20 x 6 x 10 T7 46-D					34071		
20 x 6 x 10 T7 46-G					34072		
20 x 6 x 10 T7 46-C			34074				
20 x 6 x 10 T7 36/46-I/J				34075			
20 x 6 x 12 T7 46-H		34078					
20 x 6 x 12 T7 46-G					34080		

Blanchard Grinding Segments

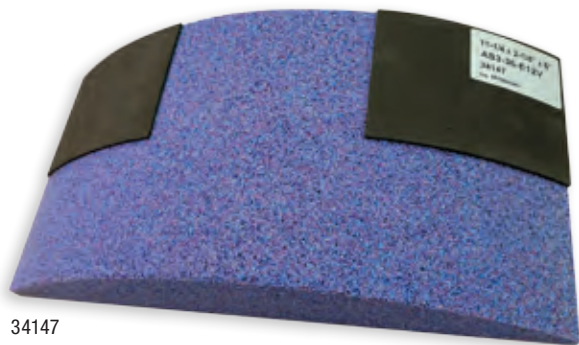

34147

AS5: New Advanced Ceramic and Bond Technology for heavy and fast stock removal.

AS3: Ceramic blend Technology for heavy stock removal.

WA: White Aluminum Oxide for general purpose performance.

* Additional size and shapes available as special make.

CGW Segments are used to grind flat workpiece surfaces. Our Segment product offering ranges from general purpose precision grinding to fast, heavy stock removal to meet your job requirement.

NEW

UPC	Size	Spec	Box Qty
AS5 – Ceramic Aluminum Oxide Plus			
34148	11-1/4" x 2-1/4" x 6"	AS5-36-E12V	6
34150	11-1/4" x 2-1/4" x 8"	AS5-36-E12V	5
34153	11-1/4" x 3" x 8"	AS5-36-E12V	5
AS3 – Ceramic Aluminum Oxide			
34147	11-1/4" x 2-1/4" x 6"	AS3-36-E12V	6
34149	11-1/4" x 2-1/4" x 8"	AS3-36-E12V	5
34152	11-1/4" x 3" x 8"	AS3-36-E12V	5
WA – White Aluminum Oxide			
34094	11-1/4" x 2-1/4" x 6"	WA-36-E12V	6
34151	11-1/4" x 2-1/4" x 8"	WA-36-E12V	5
34154	11-1/4" x 3" x 8"	WA-36-E12V	5

Bench & Pedestal Wheels, 6" – 18" Diameter

- CGW Bench and pedestal grinding wheels are used for general stock removal, sharpening, deburring, and shaping. Bench grinder and pedestal grinder wheels are available in diameters up to 18".
- Common settings for bench and pedestal grinders are in maintenance departments, tool & die shops, and metal fabrication shops.



Type 1

Box Qty: 1 for all Bench Wheel Sizes

Size – Grit – Hardness	A Brown	AZ Blue	GC Green	WA White
6"				
6 x 1/2 x 1 T1 46-M	38003			
6 x 1/2 x 1 T1 60-M	38004			
6 x 1/2 x 1 T1 60-I			38501	
6 x 1/2 x 1 T1 80-I			38502	
6 x 1/2 x 1 T1 100-I			38503	
6 x 3/4 x 1 T1 36-O	38007			
6 x 3/4 x 1 T1 46-M	38008			
6 x 3/4 x 1 T1 60-M	38009			
6 x 3/4 x 1 T1 80-M	38010			
6 x 3/4 x 1 T1 36-K		38111		
6 x 3/4 x 1 T1 60-K		38113		38613
6 x 3/4 x 1 T1 80-K		38114		38616
6 x 3/4 x 1 T1 120-K		38116		
6 x 3/4 x 1 T1 60-I			38504	
6 x 3/4 x 1 T1 80-I			38505	
6 x 3/4 x 1 T1 100-I			38506	
6 x 1 x 1 T1 24-Q	38011			
6 x 1 x 1 T1 36-O	38012			
6 x 1 x 1 T1 46-M	38013			
6 x 1 x 1 T1 60-M	38014			
6 x 1 x 1 T1 80-M	38015			
6 x 1 x 1 T1 36-K		38121		
6 x 1 x 1 T1 60-K		38123		38623
6 x 1 x 1 T1 120-K		38126		38626
6 x 1 x 1 T1 60-I			38507	
6 x 1 x 1 T1 80-I			38508	
6 x 1 x 1 T1 100-I			38509	
6 x 1 x 1 T1 120-I			38580	
7"				
7 x 3/4 x 1 T1 60-I			38510	
7 x 3/4 x 1 T1 80-I			38511	
7 x 3/4 x 1 T1 100-I			38512	
7 x 1 x 1 T1 24-Q	38016			
7 x 1 x 1 T1 36-O	38017			
7 x 1 x 1 T1 46-M	38018			
7 x 1 x 1 T1 60-M	38019			
7 x 1 x 1 T1 80-M	38020			
7 x 1 x 1 T1 36-K		38161		
7 x 1 x 1 T1 60-K		38163		38663
7 x 1 x 1 T1 60-I			38513	
7 x 1 x 1 T1 80-I			38514	
7 x 1 x 1 T1 100-I			38515	

Size – Grit – Hardness	A Brown	AZ Blue	GC Green	WA White
8"				
8 x 3/4 x 1 T1 46-M	35044			
8 x 1 x 1 1/4 T1 24-Q	38021			
8 x 1 x 1 1/4 T1 36-O	38022			
8 x 1 x 1 1/4 T1 46-M	38023			
8 x 1 x 1 1/4 T1 60-M	38024			
8 x 1 x 1 1/4 80-M	38025			
8 x 1 x 1 1/4 T1 36-K		38201		
8 x 1 x 1 1/4 60-K		38203		38703
8 x 1 x 1 1/4 T1 80-K		38204		
8 x 1 x 1 1/4 120-K		38206		38706
8 x 1 x 1 1/4 T1 60-I			38516	
8 x 1 x 1 1/4 T1 80-I			38517	
8 x 1 x 1 1/4 T1 120-I			38518	
10"				
10 x 1 x 1 1/4 T1 24-Q	38026			
10 x 1 x 1 1/4 T1 36-O	38027			
10 x 1 x 1 1/4 T1 46-M	38028			
10 x 1 x 1 1/4 T1 60-M	38029			
10 x 1 x 1 1/4 T1 80-M	38030			
10 x 1 x 1 1/4 T1 60-I			38519	
10 x 1 x 1 1/4 T1 80-I			38520	
10 x 1 x 1 1/4 T1 100-I			38521	
10 x 1 1/2 x 1 1/4 T1 24-Q	38031			
10 x 1 1/2 x 1 1/4 T1 36-O	38032			
10 x 1 1/2 x 1 1/4 T1 46-M	38033			
10 x 1 1/2 x 1 1/4 T1 60-M	38034			
10 x 1 1/2 x 1 1/4 T1 80-M	38035			
10 x 1 1/2 x 1 1/4 T1 60-I			38522	
10 x 1 1/2 x 1 1/4 T1 80-I			38523	
10 x 2 x 1 1/4 T1 30/36-O	35073			
10 x 2 x 1 1/4 T1 54-M	35074			
12"				
12 x 1 x 1 1/4 T1 24-Q	38036			
12 x 1 x 1 1/4 T1 46-M	38038			
12 x 1 x 1 1/4 T1 60-M	38039			
12 x 1 x 1 1/4 T1 60-I			38525	
12 x 1 1/2 x 1 1/4 T1 36-O	38042			
12 x 1 1/2 x 1 1/4 T1 46-M	38043			
12 x 1 1/2 x 1 1/4 T1 60-M	38044			
12 x 1 1/2 x 1 1/4 T1 60-I			38528	
12 x 1 1/2 x 1 1/4 T1 80-I			38529	
12 x 2 x 1 1/2 T1 24-Q	38046			

Bench & Pedestal Wheels, 6" – 18" Diameter (Continued)

Size – Grit – Hardness	A Brown	AZ Blue	GC Green	WA White
12 x 2 x 11/2 T1 36-0	38047			
12 x 2 x 11/2 T1 46-M	38048			
12 x 2 x 11/2 T1 60-M	38049			
12 x 2 x 11/2 T1 80-M	38050			
12 x 2 x 11/2 T1 60-I			38531	
12 x 2 x 11/2 T1 80-I			38532	
12 x 2 x 11/2 T1 100-I			38533	
14"				
14 x 2 x 11/2 T1 24-Q	38051			
14 x 2 x 11/2 T1 36-0	38052			
14 x 2 x 11/2 T1 46-M	38053			
14 x 2 x 11/2 T1 60-M	38054			
14 x 2 x 11/2 T1 60-I			38534	
14 x 2 x 11/2 T1 80-I			38535	
14 x 3 x 11/2 T1 24/30-Q	35107			
14 x 3 x 11/2 T1 46/54-M	35108			

Size – Grit – Hardness	A Brown	AZ Blue	GC Green	WA White
16"				
16 x 2 x 11/2 T1 24-Q	35109			
16 x 2 x 11/2 T1 36-M	35110			
18 x 3 x 11/2 T1 36-0	35113			
18 x 3 x 11/2 T1 54-M	35114			

Box Qty: 1 for all Bench Wheel Sizes

Wheel Bushings

Width	1" Hole Reduces to 3/4", 5/8", 1/2" (4pcs set)	1-1/4" Hole Reduces to 1"	1-1/2" Hole Reduces to 1-1/4"	Box
1/2"	51000	51003	51006	1
3/4"	51001	51004	51007	1
1"	51002	51005	51008	1

Dressing Wheels, Sticks

- Combination Stone: Designed to clean magnetic chucks.
- Dressing Wheels: Brake controlled truing devices used for dressing/opening diamond wheels.
- Dressing Sticks: Dressing and opening resin bonded wheels.
- Silicon Carbide abrasive grain.



UPC	Size	Specs	Box	Master
Dressing Wheels 10,823 R.P.M.				
35905	3 x 1/2 x 1/2	72C-80-L-V	50	100
35906	3 x 1 x 1/2	72C-60-L-V	20	40
35907	3 x 1 x 1/2	72C80-J-XV	20	40
35908	3 x 1 x 1/2	72C-80-L-V	20	40

UPC	Size	Specs	Box	Master
Round – Combination Stone				
35902	4 x 1/2	C150/320-MN7	20	40
Dressing Sticks				
35909	1 x 1 x 6	C24-S-V	50	100

Centerless, Cylindrical Wheels

Centerless Grinding

The workpiece lies between two wheels; the grinding wheel and the feed regulating wheel. Feed wheel diameter is always proportionally smaller than the grinding wheel it is matched with [see chart below].

Three Basic Types of Centerless Grinding

Through Feed – Most commonly used centerless grinding where straight cylindrical parts are passed from the entrance on the machine, through, and out the exit side.

In-Feed (Plunge) – Used on part with a shape that does not allow axial movement. Frequently, several diameters are ground at once by using a specially formed wheel face, or by mounting two or more wheels on the same spindle.

End-Feed – For producing or finishing a taper in the workpiece. The parts are fed in the entrance side of the machine up to a fixed end point.

Cylindrical Grinding – The precision grinding of the outer surface of any round workpiece. The workpiece is held between centers or in chucks.

- Popular Markets – machine shops, aerospace, automotive, and bearings.
- Common Applications – needle bearing, aerospace fasteners, motor shafts, transmission and engine components.



94AB BAS – Advanced grain technology used in Cylindrical and Centerless applications. This grain can be used to grind steels in either soft or hard state.

Centerless Wheel Selection Chart

Size – Grit – Hardness	94AB BAS	PA Pink	WAG White	C Black	GC Green
14"					
14 x 1 x 5 T1 54-K	35201				
14 x 1 x 5 T1 80-M	35203				
14 x 11/4 x 5 T1 54-K	35204				
14 x 11/2 x 5 T5 54-K	35207				
14 x 11/2 x 5 T5 80-M	35209				
14 x 2 x 5 T5 54-K	35210				
14 x 2 x 5 T5 60-L	35211				
14 x 2 x 5 T5 80-M	35212				
14 x 2 x 5 T1 80-K					37801
16 x 1 x 5 T1 80-K					37803
16 x 1 x 5 T1 60-L	35213				
16 x 1 x 5 T1 80-M	35214				
16"					
16 x 11/2 x 5 T1 80-K					37806
16 x 11/2 x 5 T1 60-L	35218				
16 x 11/2 x 5 T1 80-M	35219				
16 x 11/2 x 8 T1 60-K		37807			
16 x 11/2 x 8 T1 54-K	35221				
16 x 11/2 x 8 T1 80-M	35223				
16 x 2 x 5 T1 80-H			37808		
16 x 2 x 5 T1 60-K		37809			
16 x 2 x 5 T1 60-L	35224				
16 x 2 x 5 T1 80-M	35225				

Centerless Wheel Selection Chart (Continued)

Size – Grit – Hardness	94AB BAS	PA Pink	WAG White	C Black	GC Green
16 x 2 x 5 T1 46-I					
16 x 2 x 5 T1 46-J					
16 x 2 x 8 T1 60-L	35230				
16 x 3 x 5 T1 80-H			37813		
16 x 3 x 5 T1 60-K		37814			
16 x 4 x 10 T1 60-L	35232				
16 x 4 x 10 T1 80-L	35233				
20"					
20 x 1 x 8 T1 80-K					37815
20 x 2 x 8 T1 60-K		37816			
20 x 3 x 8 T1 80-H			37817		
20 x 3 x 8 T1 60-K		37818			
20 x 1 x 12 T1 60-M	35236				
20 x 1 x 12 T1 80-O	35237				
20 x 2 x 12 T1 80-K					37821
20 x 2 x 12 T1 60-K	35241				
20 x 2 x 12 T1 60-L	35242				
20 x 2 x 12 T1 60-M	35243				
20 x 2 x 12 T1 80-P	35246				
20 x 2 x 12 T1 80-N/120-S	35247				
20 x 2 1/2 x 12 T1 80-N/120-S	35251				
20 x 3 x 12 T1 60-K	35254				
20 x 4 x 12 T1 60-K	35266				
20 x 4 x 12 T1 60-L	35267				
20 x 4 x 12 T1 80-M	35270				
20 x 4 x 12 T1 80-P	35272				
20 x 4 x 12 T1 80-N/120-S	35273				
20 x 6 x 12 T1 60-J	35277				
20 x 6 x 12 T1 60-K	35278				
20 x 6 x 12 T1 60-L	35279			35287	
20 x 6 x 12 T1 60-M	35280				
20 x 6 x 12 T1 80-J	35281				
20 x 6 x 12 T1 80-L	35282				
20 x 6 x 12 T1 80-M	35283				
20 x 6 x 12 T1 80-N/120-S	35286				
20 x 8 x 12 T1 54-J	35292				
20 x 8 x 12 T1 60-K	35293				
20 x 8 x 12 T1 60-L	35294				
20 x 8 x 12 T1 60-M	35295				
20 x 8 x 12 T1 80-J	35296				
20 x 8 x 12 T1 80-L	35297				
20 x 8 x 12 T1 80-M	35298				
20 x 8 x 12 T1 80-O	35299				
20 x 8 x 12 T1 80-N/120-S	35300				
24"					
24 x 1 x 12 T1 60-K		37829			
24 x 2 x 12 T1 60-K	35314	37831			
24 x 2 x 12 T1 80-N/120-S	35319				
24 x 2 1/2 x 12 T1 80-N/120-S	35321				
24 x 3 x 12 T1 80-H			37833		
24 x 3 x 12 T1 60-K	35324				
24 x 4 x 12 T1 60-K	35333				
24 x 4 x 12 T1 60-L	35334				

Centerless Wheel Selection Chart (Continued)

Size – Grit – Hardness	94AB BAS	PA Pink	WAG White	C Black	GC Green
24 x 4 x 12 T1 80-M	35337				
24 x 4 x 12 T1 80-N/120-S	35339				
24 x 6 x 12 T1 60-K	35342				
24 x 6 x 12 T1 60-L	35343				
24 x 6 x 12 T1 80-J	35345				
24 x 6 x 12 T1 80-N/120-S	35349				
24 x 8 x 12 T1 60-K	35352				
24 x 8 x 12 T1 60-L	35353			35360	
24 x 8 x 12 T1 60-M	35354				
24 x 8 x 12 T1 80-J	35355				
24 x 8 x 12 T1 80-L	35356				
24 x 10 x 12 T1 60-K	35363				
24 x 20 x 12 T1 60-K	35368				
24 x 20 x 12 T1 60-M	35370				

Feed Regulating Wheels

Benefits of Calendered Rubber Feed Wheels (CDR)

Calendered wheels are best used on thinner feed regulating wheels or when the cast natural rubber wheel deflects under pressure. The calendered wheel is preferred when close tolerances are required or there is excessive wheel wear on the standard feed wheel.

Benefits of Cast Natural Rubber Feed Wheels (RX)

This wheel gives the best drive or braking action while resisting spin out of parts.

This grade is satisfactory for the majority of applications. For harder grades, see Calendered Wheels.

All CGW Feed Regulating wheels are manufactured with an isostatic process assuring perfect gripping and elimination of hard spots and voids, a common problem with rubberized wheels.

- A80-R2-RX – Natural Rubber
- A80-R2-CDR – Calendered Rubber

R/2: Recess Two Sides – Type 7 Wheel

R/1: Recess One Side – Type 5 Wheel

D/S: Other Side of Wheel

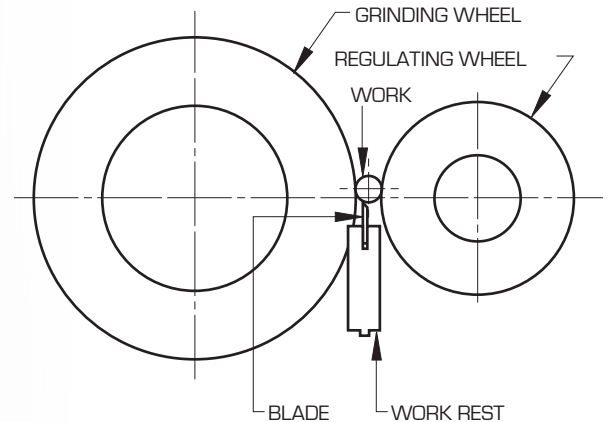

Size	UPC	Spec	Recess
9 x 4 x 4	35376	T7 A80-R2-RX	R/2 - 5-1/4 x 5/8
12 x 1 x 5	35239	T1 A80-R2-RX	N/A
12 x 2 x 5	35248	T1 A80-R2-RX	N/A
12 x 2 1/2 x 5	35384	T1 A80-R2-RX	N/A
12 x 3 x 5	35261	T1 A80-R2-RX	N/A
12 x 4 x 5	35274	T7 A80-R2-RX	R/2 - 7-1/2 x 1/2
12 x 6 x 5	35290	T7 A80-R2-RX	R/2 - 7-1/2 x 1/2 O/S - 7-1/2 x 1-1/2
12 x 6 x 5	35288	T7 A80-R2-RX	R/2 - 7-1/2 x 1-1/2
12 x 8 x 5	35302	T5 A80-R2-RX	R/1 - 7-1/2 x 1-1/2
12 x 8 x 5	35390	T7 A80-R2-RX	R/2 - 7-1/2 x 1-1/2
12 x 8 x 5	35303	T7 A80-R2-RX	R/2 - 7-1/2 x 1-1/2 O/S - 7-1/2 x 2-1/2
12 x 10 x 5	35308	T7 A80-R2-RX	R/2 - 8 x 1-1/2 O/S - 8 x 2
14 x 8 x 5	35361	T7 A80-R2-RX	R/2 - 8 x 1-1/2 O/S - 8 x 2
14 x 8 x 5	35362	T7 A80-R2-RX	R/2 - 8 x 1-1/2 O/S - 8 x 2-1/2
14 x 20 x 6	35372	T7 A80-R2-RX	R/2 - 8-1/2 x 1-1/2
12 x 6 x 5	35291	T7 A80-R2-CDR	R/2 - 7-1/2 x 1/2 O/S - 7-1/2 x 1-1/2
12 x 6 x 5	35289	T7 A80-R2-CDR	R/2 - 7-1/2 x 1-1/2
12 x 8 x 5	35304	T7 A80-R2-CDR	R/2 - 7-1/2 x 1-1/2 O/S - 7-1/2 x 2-1/2

Tool & Cutter Wheels

The standard shapes most commonly used in tool & cutter grinding are:







- **T-6** – Straight Cup Wheel
- **T-11** – Flaring Cup
- **T-12** – Dish Wheels
- **T-50** – Plate Mount Wheels



The shape of the wheel is determined by the shape, Size, and accessibility of the part to be ground.

When grinding peripheral cutters, cup wheels are used. Dish wheels are best for formed cutters.

surface speed = 35 m/s

							
	4 x 2 x 20mm	4/3 x 1-1/2 x 1-1/4	5/3-3/4 x 1-3/4 x 1-1/4	5 x 11/2 x 1-1/4	6 x 2 x 1-1/4	6 x 1/2 x 1-1/4	6 x 1 x 4
	Deckel Cup T6	Flaring Cup T11	Flaring Cup T11	Straight Cup T6	Straight Cup T6	Dish Wheel T12	Plate Mount Wheel T50
WA 46H			34914				
WA 46I			34915				
WA 46J		34903	34916	34929			
WA 46K		34904	34917	34930		34942	34948
WA 60I			34919				
WA 60J		34907	34920	34933		34943	
WA 60K		34908	34921		34941	34944	
WA 80J	34900						
WA 80K		34909	34923	34936			
PA 46I			58058				
PA 46K		58054	58059				
PA 60K			58060				
PA 80K		58057					
AS3 46I		34200	34203				
AS3 60J			34204				
AS3 60K		34201					
GC 60I							34949
GC 80I							34950
GC 100I							34951
GC 120I							34952

WA: White Premium Aluminum Oxide
PA: Pink Aluminum Oxide

AS3: Ceramic Aluminum Oxide
GC: Green Silicon Carbide

Mounted Points Premium Pink Aluminum Oxide

- Used in almost every industry but primarily in tool and die shops, and foundries. General applications: Deburring, tool sharpening, finishing cavities, and removes mold marks and parting lines.
- Mounted points are classified by shape groups A, B, and W.
- The semi-friable pink PA abrasive is used to produce sharp, consistent cutting action.



UPC	Size	Dimension	Shank	Box	Master
A-Shape Mounted Points			R.P.M.*		
35951	A-1	7/8 x 2-1/2	1/4 Shank	10	20
35953	A-3	7/8 x 2-3/4	1/4 Shank	10	20
35954	A-4	1-1/4 x 1-1/4	1/4 Shank	10	20
35955	A-5	3/4 x 1-1/8	1/4 Shank	10	20
35957	A-11	7/8 x 2	1/4 Shank	10	20
35975	A-38	1 x 1	1/4 Shank	10	20

UPC	Size	Dimension	Shank	Box	Master
B-Shape Mounted Points			R.P.M.*		
35980	B-44	7/32 x 3/8	1/8 Shank	10	20
35985	B-52	3/8 x 3/4	1/8 Shank	10	20
36009	B-132	3/8 x 1/2	1/8 Shank	10	20

UPC	Size	Dimension	Shank	Box	Master
W-Shape Mounted Points			R.P.M.*		
36042	W-189	1/2 x 2	1/4 Shank	10	20
36058	W-220	1 x 1	1/4 Shank	10	20
36060	W-222	1 x 2	1/4 Shank	10	20
36067	W-236	1-1/2 x 1/2	1/4 Shank	10	20

* No matter what factors of wheel size, shape, specification, mandrel size, overhang, or machine conditions are changed, **the speed of 10,000 SFPM shall not be exceeded.**

Cotton Fiber Mounted Points

- Aircraft/Aerospace, Automotive, Tool & Die, Fabrication.
- Debur, blend and finish with one mounted point.
- Provide superior metal removal control without changing part geometry.
- Ideal for deburring and polishing stainless steel, aluminum, mild steel and exotic metals.



UPC	Shape	Size	Shank Diameter	Shank Length	Spec	RPM	Box
49561	W163	1/4 x 1/2	1/8"	1-1/2"	A80GFX	59,990	25
49563	W163	1/4 x 1/2	1/8"	1-1/2"	A120GFX	59,990	25
49564	W177	3/8 x 3/4	1/8"	1-1/2"	A80GFX	33,750	25
49566	W177	3/8 x 3/4	1/8"	1-1/2"	A120GFX	33,750	25
49567	B52	3/8 x 3/4	1/8"	1-1/2"	A80GFX	45,370	25
49569	B52	3/8 x 3/4	1/8"	1-1/2"	A120GFX	45,370	25

32A ID (Internal Dimension) Wheels

- For grinding inside surfaces of bearings, rings, cylinders, barrels, and bores.
- Designed for concentricity, precision, rigidity, and efficiency.



UPC	Specs	Rpm	Box	Master
59050	3/4 x 3/4 x 1/4 (3/8 x 3/8) 32A60-J8-V	33,500	20	40
59051	1 x 1 x 1/4 T5 (1/2 x 1/2) 32A60-J8-V	26,800	20	40
59052	1 x 1 x 3/8 T5 (1/2 x 1/2) 32A60-J8-V	26,800	20	40
59053	1-1/4 x 1 x 3/8 T5 (5/8 x 1/2) 32A60-J8-V	20,900	20	40
59054	1-1/2 x 1 x 3/8 T5 (5/8 x 1/2) 32A60-J8-V	16,750	20	40
59055	1-1/2 x 1 x 3/8 T5 (3/4 x 1/2) 32A60-J8-V	16,750	20	40
59056	2 x 1 x 3/8 T5 (3/4 x 3/8) 32A60-J8-V	13,400	20	40
59057	2 x 1 1/2 x 5/8 T5 (1 x 3/4) 32A60-J8-V	13,400	20	40



CONVOLUTE, DEBURRING, UNITIZED WHEELS

Convolute Wheels

- CGW convolute wheels are made for long working life even if put in contact with sharp edges.
- Convolute wheels improve work surfaces without changing shapes or dimensions.
- Convolute wheels resist heating up and loading.

ALUMINUM OXIDE

SILICON CARBIDE

A=Aluminum Oxide,
S=Silicon Carbide



Size	RPM	Box Qty	7 / S FINE	8 / A MEDIUM	8 / S FINE	9 / S FINE
6 x 1/2 x 1	6,000	4	70130	70131	70132	70133
6 x 1 x 1	6,000	2	70134	70135	70136	70137
8 x 1/2 x 3	4,500	4		70139	70140	70141
8 x 1 x 3	4,500	2		70143	70144	70145
8 x 2 x 3	4,500	1			70148	70149

• Deburring Wheels

- Designed for high stock removal, cool working and easy work piece conformability.
- Quickly removes light burrs, blends machine & belt marks and applies final finishes.
- For metal, stainless steel, titanium and composite materials. **8S & 9S fine good for aluminum.**

Deburring Wheels – Metal & Multi Finishing

Metal

- Made for uniform finishing & light deburring without changing work piece dimensions.
- Provides uniform distinct satin, cosmetic, brushed and antique finishes.
- Blend coated abrasive scratch patterns and tool marks.

Multi Finishing

- Made for general purpose cleaning, rust and discoloration from welds removal.
- Long life, high stock removal, conforms to work piece. **Runs directional.**



A=Aluminum Oxide,
S=Silicon Carbide

Size	RPM	Box Qty	MULTI FINISHING		METAL
			2 / S / COARSE	2 / S / MEDIUM	5 / A / MEDIUM
6 x 1 x 1	6,000	2	70154	70155	70150
6 x 2 x 1	6,000	1	70156	70157	70151
8 x 2 x 3	4,500	1		70160	70153

ALUMINUM OXIDE

SILICON CARBIDE



For metal, plastic & composite materials.

Unitized Wheels

- Non-woven material impregnated with resin and compressed for finishing and long working life. Easily deburrs, cleans, blends and polishes.
- **Wheels with Arbor Hole** designed to resist tearing when working on sharp parts and edges. For metal, stainless steel, titanium, composite materials.

Size	RPM	Box Qty	2 / S FINE	3 / S FINE	2 / A MEDIUM
Unitized Wheels with Arbor Hole					
3 x 1/4 x 1/4	15,100	25		72013	
6 x 1/2 x 1/2	7,500	10		72018	
6 x 1/2 x 1	7,500	10	72008		72009



Unitized Wheels with Arbor Hole

ALUMINUM OXIDE

SILICON CARBIDE

INDEX

UPC #	Page #	UPC #	Page #	UPC #	Page #	UPC #	Page #	UPC #	Page #	UPC #	Page #	UPC #	Page #	UPC #	Page #
30001	14	31171	12	34078	80	34319	76	34436	78	34625	77	34763	78	35108	82
30002	14	31172	12	34080	80	34320	76	34437	78	34626	77	34766	78	35109	82
30004	14	31174	12	34094	80	34321	76	34440	78	34627	76	34769	78	35110	82
30005	14	31175	12	34114	77	34324	76	34445	78	34628	76	34770	78	35113	82
30006	14	31201	12	34115	78	34325	76	34447	78	34629	77	34771	78	35114	82
30011	14	31202	12	34116	79	34326	76	34448	78	34633	76	34774	78	35130	27
30012	14	31204	12	34147	80	34328	76	34449	78	34634	76	34775	78	35131	27
30014	14	31205	12	34148	80	34329	76	34452	78	34635	76	34778	78	35132	27
30015	14	31231	12	34149	80	34330	77	34454	78	34636	77	34779	78	35133	27
30016	14	31232	12	34150	80	34332	77	34456	78	34638	77	34781	78	35134	27
30022	14	31234	12	34151	80	34333	77	34458	78	34640	77	34786	78	35135	27
30024	14	31235	12	34152	80	34335	77	34459	79	34642	77	34790	78	35201	83
30025	14	31261	12	34153	80	34336	77	34460	79	34644	77	34792	78	35203	83
30026	14	31262	12	34154	80	34337	77	34462	79	34645	77	34793	79	35204	83
30032	14	31264	12	34200	86	34341	77	34464	79	34647	77	34794	79	35207	83
30034	14	31265	12	34201	86	34342	77	34465	79	34648	77	34795	79	35209	83
30035	14	34003	79	34203	86	34343	77	34466	79	34649	77	34798	79	35210	83
30036	14	34004	79	34204	86	34344	77	34467	79	34652	77	34801	78	35211	83
30060	15	34006	79	34207	76	34345	77	34469	79	34653	77	34802	78	35212	83
30062	15	34007	79	34208	76	34348	77	34470	79	34655	77	34803	78	35213	83
30063	15	34014	79	34209	76	34349	77	34472	79	34656	77	34808	79	35214	83
30066	15	34021	79	34210	76	34350	77	34473	79	34657	77	34809	79	35218	83
30068	15	34022	79	34212	76	34351	77	34474	79	34663	77	34811	79	35219	83
30069	15	34023	79	34213	76	34352	77	34480	79	34664	77	34812	79	35221	83
30142	10	34025	79	34214	77	34353	77	34481	79	34669	77	34813	79	35223	83
30144	10	34027	79	34215	77	34354	77	34482	79	34671	77	34816	79	35224	83
30145	10	34028	79	34217	78	34355	77	34486	79	34672	77	34830	78	35225	83
30146	10	34029	79	34219	78	34356	77	34487	79	34673	77	34900	86	35230	84
30152	10	34030	79	34220	78	34357	77	34488	79	34674	77	34903	86	35232	84
30154	10	34032	80	34221	78	34358	77	34489	79	34676	77	34904	86	35233	84
30155	10	34033	80	34222	78	34359	77	34490	79	34677	77	34907	86	35236	84
30162	10	34034	80	34223	78	34360	77	34491	79	34678	77	34908	86	35237	84
30164	10	34035	80	34225	78	34364	77	34493	79	34679	77	34909	86	35239	85
30202	10	34036	80	34226	78	34366	77	34495	79	34680	77	34914	86	35241	84
30204	10	34037	80	34227	78	34367	77	34496	79	34681	77	34915	86	35242	84
30205	10	34038	80	34230	78	34369	77	34497	79	34682	77	34916	86	35243	84
30212	10	34039	80	34232	78	34383	78	34600	76	34683	77	34917	86	35246	84
30214	10	34040	80	34233	78	34387	78	34603	76	34685	77	34919	86	35247	84
30215	10	34041	80	34234	79	34390	78	34604	76	34688	77	34920	86	35248	85
30222	10	34043	80	34235	79	34391	78	34605	76	34689	77	34921	86	35251	84
30224	10	34044	80	34238	78	34392	78	34606	76	34690	77	34923	86	35254	84
30225	10	34046	80	34239	78	34395	78	34607	76	34692	77	34929	86	35261	85
31011	12	34048	80	34240	79	34396	78	34608	76	34697	77	34930	86	35266	84
31012	12	34049	80	34241	79	34411	78	34609	76	34698	77	34933	86	35267	84
31014	12	34051	80	34245	80	34413	78	34610	76	34700	77	34936	86	35270	84
31015	12	34055	80	34250	76	34414	78	34611	76	34701	77	34941	86	35272	84
31051	12	34057	80	34252	77	34418	78	34612	76	34702	77	34942	86	35273	84
31052	12	34059	80	34254	77	34419	78	34613	76	34703	77	34943	86	35274	85
31054	12	34060	80	34301	76	34421	78	34615	76	34705	77	34944	86	35277	84
31055	12	34063	80	34303	76	34422	78	34616	76	34725	78	34948	86	35278	84
31091	12	34064	80	34308	76	34425	78	34617	76	34729	78	34949	86	35279	84
31092	12	34067	80	34309	76	34426	78	34618	76	34742	78	34950	86	35280	84
31094	12	34069	80	34310	76	34427	78	34619	76	34744	78	34951	86	35281	84
31095	12	34070	80	34312	76	34429	78	34620	76	34752	78	34952	86	35282	84
31131	12	34071	80	34313	76	34430	78	34621	76	34755	78	35044	81	35283	84
31132	12	34072	80	34315	76	34433	78	34622	76	34759	78	35073	81	35286	84
31134	12	34074	80	34317	76	34434	78	34623	76	34761	78	35074	81	35287	84
31135	12	34075	80	34318	76	34435	78	34624	77	34762	78	35107	82	35288	85

INDEX

UPC #	Page #	UPC #	Page #	UPC #	Page #	UPC #	Page #	UPC #	Page #	UPC #	Page #	UPC #	Page #	UPC #	Page #
35289	85	35517	26	35666	40	36109	38	36234	33	37099	56	37782	79	38051	82
35290	85	35518	26	35667	40	36110	38	36235	18	37100	56	37801	83	38052	82
35291	85	35575	33	35670	33	36113	34	36236	18	37103	56	37803	83	38053	82
35292	84	35576	33	35673	37	36116	34	36237	18	37104	56	37806	83	38054	82
35293	84	35577	32	35674	37	36122	33	36238	72	37105	56	37807	83	38111	81
35294	84	35582	32	35675	39	36123	33	36239	72	37530	37	37808	83	38113	81
35295	84	35584	32	35676	39	36124	33	36240	72	37531	37	37809	83	38114	81
35296	84	35587	34	35677	37	36125	33	36241	49	37535	37	37813	84	38116	81
35297	84	35589	34	35678	37	36126	34	36242	49	37543	37	37814	84	38121	81
35298	84	35590	34	35679	40	36133	33	36243	49	37700	76	37815	84	38123	81
35299	84	35592	34	35680	40	36142	34	36246	40	37701	76	37816	84	38126	81
35300	84	35599	34	35681	40	36143	34	36247	40	37702	76	37817	79	38161	81
35302	85	35600	34	35682	40	36144	34	36248	40	37703	76	37818	80	38163	81
35303	85	35601	34	35687	31	36147	34	36249	40	37704	76	37821	84	38201	81
35304	85	35602	34	35688	31	36156	38	36250	57	37705	76	37829	84	38203	81
35308	85	35603	34	35689	31	36157	38	36255	38	37706	76	37831	84	38204	81
35314	84	35605	34	35690	31	36158	34	36256	38	37707	77	37833	84	38206	81
35319	84	35606	34	35691	31	36159	34	36259	38	37708	77	38003	81	38501	81
35321	84	35611	37	35699	38	36160	34	36260	38	37709	77	38004	81	38502	81
35324	84	35612	39	35830	18	36161	34	36261	38	37710	77	38007	81	38503	81
35333	84	35613	39	35831	18	36162	35	36262	38	37712	78	38008	81	38504	81
35334	84	35616	39	35832	18	36163	35	36283	49	37714	78	38009	81	38505	81
35337	85	35617	39	35833	18	36173	30	36284	49	37715	78	38010	81	38506	81
35339	85	35620	37	35834	18	36174	30	36285	49	37716	78	38011	81	38507	81
35342	85	35621	37	35835	18	36175	30	36286	49	37717	78	38012	81	38508	81
35343	85	35622	38	35836	18	36176	30	36287	49	37718	78	38013	81	38509	81
35345	85	35623	38	35837	18	36177	30	36288	49	37719	78	38014	81	38510	81
35349	85	35624	37	35838	18	36178	30	36292	18	37720	78	38015	81	38511	81
35352	85	35625	37	35839	18	36179	30	36293	18	37721	79	38016	81	38512	81
35353	85	35626	37	35840	18	36180	30	36294	18	37722	79	38017	81	38513	81
35354	85	35627	38	35841	18	36181	30	36301	28	37723	79	38018	81	38514	81
35355	85	35628	37	35842	18	36182	30	36302	28	37724	79	38019	81	38515	81
35356	85	35629	38	35843	18	36183	30	36303	28	37726	79	38020	81	38516	81
35360	85	35630	39	35844	18	36184	30	36304	28	37728	76	38021	81	38517	81
35361	85	35631	39	35845	18	36185	30	36316	8	37732	77	38022	81	38518	81
35362	85	35632	37	35851	32	36186	30	36317	8	37733	77	38023	81	38519	81
35363	85	35633	37	35900	72	36189	39	36318	8	37736	77	38024	81	38520	81
35368	85	35634	39	35901	72	36190	39	36319	8	37737	78	38025	81	38521	81
35370	85	35635	39	35902	82	36204	21	36320	8	37738	78	38026	81	38522	81
35372	85	35640	37	35905	82	36205	21	36321	8	37739	78	38027	81	38523	81
35376	85	35641	37	35906	82	36206	21	36322	8	37740	78	38028	81	38525	81
35384	85	35642	38	35907	82	36207	57	36323	8	37742	78	38029	81	38528	81
35390	85	35643	38	35908	82	36208	57	36324	8	37745	78	38030	81	38529	81
35500	31	35644	37	35909	82	36209	57	36325	8	37746	78	38031	81	38531	82
35501	31	35645	37	35951	87	36210	57	36326	8	37747	78	38032	81	38532	82
35502	31	35646	38	35953	87	36211	57	36327	8	37748	79	38033	81	38533	82
35503	31	35647	38	35954	87	36212	57	36450	58	37749	79	38034	81	38534	82
35504	31	35648	39	35955	87	36213	57	36451	58	37750	79	38035	81	38535	82
35505	31	35649	39	35957	87	36214	57	36452	58	37751	79	38036	81	38580	81
35506	31	35654	37	35975	87	36215	57	36453	58	37752	79	38038	81	38613	81
35507	31	35655	37	35980	87	36216	57	36454	58	37753	79	38039	81	38616	81
35508	31	35656	38	35985	87	36217	57	36455	58	37754	78	38042	81	38623	81
35509	31	35657	38	36009	87	36218	57	36456	58	37755	78	38043	81	38626	81
35510	31	35658	37	36042	87	36219	39	36457	58	37761	78	38044	81	38663	81
35511	31	35659	37	36058	87	36220	39	36458	58	37764	79	38046	81	38703	81
35512	31	35660	38	36060	87	36223	39	36459	58	37768	76	38047	82	38706	81
35514	26	35661	38	36067	87	36224	39	36460	58	37771	77	38048	82	39202	13
35515	28	35664	40	36107	38	36231	38	36461	58	37773	78	38049	82	39204	13
35516	26	35665	40	36108	38	36232	38	37098	56	37779	78	38050	82	39205	13

INDEX

UPC #	Page #	UPC #	Page #	UPC #	Page #	UPC #	Page #	UPC #	Page #	UPC #	Page #	UPC #	Page #	UPC #	Page #
39212	13	39912	56	40006	56	41523	56	41965	9	42326	7	42525	7	42765	7
39214	13	39913	56	40007	57	41524	56	41971	9	42330	7	42526	7	42772	7
39401	13	39914	56	40008	57	41525	56	41972	9	42331	7	42531	7	42774	7
39402	13	39915	56	40009	57	41526	56	41974	9	42332	7	42532	7	42775	7
39404	13	39916	56	41000	57	41527	56	41992	9	42334	7	42534	7	42801	5
39405	13	39917	56	41004	57	41528	56	42002	9	42335	7	42541	6	42802	5
39406	13	39920	56	41005	57	41529	56	42012	9	42336	7	42542	6	42804	5
39407	13	39921	56	41006	57	41530	56	42020	15	42341	6	42544	6	42805	5
39410	13	39922	56	41007	57	41608	57	42021	15	42342	6	42545	6	42811	5
39411	13	39923	56	41015	56	41630	56	42022	15	42344	6	42551	6	42812	5
39412	13	39924	56	41016	56	41631	56	42023	15	42345	6	42552	6	42821	5
39414	13	39925	56	41017	56	41701	9	42025	15	42346	6	42554	6	42822	5
39415	13	39926	56	41018	56	41702	9	42026	15	42351	6	42561	7	42831	5
39416	13	39927	56	41019	56	41704	9	42027	15	42352	6	42562	7	42832	5
39417	13	39928	56	41020	56	41705	9	42028	15	42354	6	42564	7	42942	11
39420	13	39929	56	41025	59	41706	9	42101	6	42355	6	42565	7	42944	11
39421	13	39930	56	41026	59	41711	9	42102	6	42356	6	42566	7	42945	11
39422	13	39931	56	41027	59	41712	9	42103	6	42361	7	42571	7	42952	11
39424	13	39932	56	41032	56	41714	9	42104	6	42362	7	42572	7	42954	11
39425	13	39933	56	41035	56	41715	9	42105	6	42364	7	42574	7	42955	11
39426	13	39934	56	41036	56	41716	9	42106	6	42365	7	42575	7	42962	11
39430	13	39935	56	41037	56	41721	9	42111	6	42366	7	42601	5	42964	11
39431	13	39936	56	41038	56	41722	9	42112	6	42371	7	42602	5	42965	11
39432	13	39937	56	41039	56	41724	9	42114	6	42372	7	42604	5	43081	13
39434	13	39938	56	41044	56	41725	9	42120	7	42374	7	42605	5	43084	13
39435	13	39939	56	41045	59	41726	9	42121	7	42375	7	42641	5	43091	13
39442	13	39941	56	41046	59	41731	9	42122	7	42376	7	42642	5	43094	13
39444	13	39942	56	41047	59	41732	9	42124	7	42401	5	42644	5	43101	13
39445	13	39943	56	41049	59	41734	9	42125	7	42402	5	42700	6	43104	13
39446	13	39947	56	41055	59	41735	9	42131	7	42404	5	42701	6	43111	13
39452	13	39948	56	41056	59	41736	9	42132	7	42405	5	42702	6	43114	13
39454	13	39949	56	41059	59	41741	9	42134	7	42411	5	42704	6	43181	13
39455	13	39950	56	41065	59	41742	9	42135	7	42412	5	42705	6	43184	13
39462	13	39951	56	41066	59	41744	9	42142	6	42414	5	42706	6	43241	13
39464	13	39952	56	41067	59	41745	9	42144	6	42415	5	42710	6	43251	13
39465	13	39953	56	41069	59	41746	9	42145	6	42441	5	42711	6	44601	60
39466	13	39954	56	41085	59	41751	9	42146	6	42442	5	42712	6	44602	60
39472	13	39955	56	41086	59	41752	9	42161	7	42444	5	42714	6	44603	60
39474	13	39956	56	41087	59	41754	9	42162	7	42445	5	42715	6	44604	60
39475	13	39960	57	41089	59	41761	9	42164	7	42451	5	42716	6	44605	60
39712	11	39961	57	41091	59	41762	9	42165	7	42452	5	42720	7	44607	60
39714	11	39964	57	41096	59	41764	9	42300	6	42454	5	42721	7	44608	60
39715	11	39965	57	41097	59	41765	9	42301	6	42455	5	42722	7	44609	60
39716	11	39966	57	41099	59	41766	9	42302	6	42500	6	42724	7	44610	60
39722	11	39967	57	41121	56	41771	9	42304	6	42501	6	42725	7	44611	60
39724	11	39977	57	41122	56	41772	9	42305	6	42502	6	42730	7	44612	60
39725	11	39978	57	41500	56	41774	9	42306	6	42504	6	42731	7	44613	60
39726	11	39979	57	41501	56	41802	9	42310	6	42505	6	42732	7	44617	60
39742	11	39980	57	41502	56	41804	9	42311	6	42510	6	42734	7	44618	60
39744	11	39988	57	41510	56	41805	9	42312	6	42511	6	42735	7	44619	60
39745	11	39989	57	41511	56	41842	9	42314	6	42512	6	42742	6	44620	60
39903	56	39990	57	41513	56	41844	9	42315	6	42514	6	42744	6	44621	60
39904	56	39991	57	41514	56	41845	9	42316	6	42515	6	42745	6	44622	60
39905	56	39998	57	41515	56	41952	9	42320	7	42516	6	42752	6	44623	60
39907	56	39999	57	41519	56	41954	9	42321	7	42520	7	42754	6	44625	60
39908	56	40003	56	41520	56	41955	9	42322	7	42521	7	42755	6	44626	60
39909	56	40004	56	41521	56	41962	9	42324	7	42522	7	42762	7	44627	60
39910	56	40005	56	41522	56	41964	9	42325	7	42524	7	42764	7	44628	60

INDEX

UPC #	Page #	UPC #	Page #	UPC #	Page #	UPC #	Page #	UPC #	Page #	UPC #	Page #	UPC #	Page #		
44629	60	44694	61	44827	48	45009	28	45212	39	48114	20	48516	21	48836	20
44630	60	44695	61	44828	48	45010	26	45213	39	48115	20	48517	21	48881	19
44631	60	44696	61	44836	48	45011	26	45214	39	48116	20	48518	21	48882	19
44632	60	44697	61	44837	48	45012	26	45215	39	48121	20	48519	21	48884	19
44633	60	44698	61	44838	48	45013	26	45218	29	48122	20	48528	21	48885	19
44634	60	44699	61	44839	48	45014	26	45219	29	48124	20	48529	21	48886	19
44635	60	44700	61	44840	48	45017	28	45220	29	48125	20	48530	21	48891	19
44636	60	44701	61	44841	48	45020	29	45221	29	48126	20	48531	21	48892	19
44640	61	44702	61	44842	48	45021	29	45222	29	48141	20	48532	21	48894	19
44641	61	44703	61	44843	48	45024	29	45223	29	48142	20	48533	21	48895	19
44642	61	44704	61	44844	48	45025	29	45234	29	48145	20	48534	21	48896	19
44643	61	44706	61	44845	48	45026	29	45235	29	48146	20	48535	21	48901	19
44644	61	44707	61	44846	48	45027	29	46691	16	48181	19	48536	21	48902	19
44645	61	44708	61	44847	48	45028	29	48001	20	48182	19	48537	21	48904	19
44646	61	44709	61	44848	48	45030	29	48002	20	48184	19	48538	21	48905	19
44647	61	44710	61	44849	48	45032	29	48004	20	48185	19	48539	21	48906	19
44648	61	44711	61	44850	48	45036	37	48005	20	48186	19	48540	21	49000	72
44649	61	44712	61	44851	48	45039	37	48006	20	48191	19	48541	21	49001	72
44650	61	44713	61	44852	48	45040	37	48007	20	48192	19	48542	21	49002	72
44651	61	44714	61	44854	48	45046	29	48008	20	48194	19	48572	59	49003	72
44652	61	44715	61	44855	48	45047	26	48010	20	48195	19	48711	20	49004	72
44653	61	44716	60	44856	48	45048	37	48011	20	48196	19	48712	20	49005	72
44654	61	44717	60	44857	48	45049	37	48012	20	48201	19	48714	20	49006	72
44655	61	44718	60	44858	48	45066	31	48014	20	48202	19	48715	20	49007	72
44656	61	44726	60	44859	48	45081	37	48015	20	48204	19	48716	20	49008	72
44657	61	44727	60	44860	48	45082	37	48016	20	48205	19	48721	20	49009	72
44658	61	44729	60	44861	48	45085	31	48017	20	48206	19	48722	20	49010	72
44659	61	44730	60	44862	48	45086	31	48018	20	48218	21	48724	20	49011	72
44660	61	44732	60	44865	48	45087	31	48020	20	48220	21	48725	20	49012	72
44661	61	44733	60	44866	48	45088	31	48021	20	48221	21	48726	20	49013	72
44662	61	44735	60	44867	48	45098	27	48022	20	48222	21	48731	20	49014	72
44663	61	44741	60	44868	48	45100	26	48024	20	48224	21	48732	20	49015	72
44664	61	44746	60	44871	48	45102	27	48025	20	48225	21	48734	20	49016	72
44665	61	44747	60	44872	48	45103	27	48026	20	48226	21	48735	20	49017	72
44666	61	44748	60	44873	48	45105	27	48027	20	48227	31	48736	20	49018	72
44667	61	44749	60	44881	48	45106	27	48028	20	48228	38	48741	20	49019	72
44668	61	44751	60	44882	48	45113	29	48030	20	48232	20	48742	20	49021	72
44669	61	44752	60	44883	48	45114	29	48031	20	48234	20	48744	20	49022	72
44670	61	44753	60	44884	48	45141	26	48032	20	48239	21	48745	20	49023	72
44671	61	44754	60	44885	48	45142	26	48033	20	48240	21	48746	20	49024	72
44672	61	44755	60	44886	48	45143	26	48034	20	48245	31	48801	20	49026	72
44673	61	44756	61	44887	48	45144	26	48035	20	48250	57	48802	20	49027	72
44674	61	44757	61	44889	48	45145	26	48036	20	48251	21	48804	20	49028	72
44675	61	44758	61	44917	48	45146	28	48037	20	48261	21	48805	20	49029	72
44676	61	44759	61	44919	48	45147	28	48038	20	48262	21	48806	20	49030	72
44677	61	44760	61	44921	48	45148	28	48039	20	48264	21	48811	20	49031	72
44678	61	44761	61	44922	48	45152	27	48041	20	48266	21	48812	20	49032	72
44679	61	44762	61	44923	48	45153	27	48042	20	48501	21	48814	20	49033	72
44680	61	44763	61	44924	48	45154	28	48044	20	48502	21	48815	20	49035	72
44681	61	44764	61	44925	48	45155	28	48045	20	48503	21	48816	20	49036	72
44682	61	44765	61	45001	26	45156	28	48046	20	48504	21	48821	20	49037	72
44683	61	44767	60	45002	26	45157	28	48101	20	48505	21	48822	20	49038	72
44684	61	44821	48	45003	28	45200	40	48102	20	48508	21	48824	20	49039	72
44685	61	44822	48	45004	28	45201	40	48104	20	48509	21	48825	20	49040	72
44686	61	44823	48	45005	26	45202	40	48105	20	48510	21	48826	20	49042	72
44687	61	44824	48	45006	28	45203	40	48106	20	48511	21	48831	20	49043	72
44688	61	44825	48	45007	26	45206	40	48111	20	48512	21	48832	20	49406	46
44689	61	44826	48	45008	26	45207	40	48112	20	48515	21	48835	20	49407	46

INDEX

UPC #	Page #	UPC #	Page #	UPC #	Page #	UPC #	Page #	UPC #	Page #	UPC #	Page #	UPC #	Page #	UPC #	Page #
49408	46	49626	18	49790	43	49975	43	51249	44	52644	45	52886	51	53251	17
49413	46	49627	18	49791	43	49976	43	51250	44	52647	45	52887	51	53252	17
49414	46	49628	18	49792	43	49977	43	51251	44	52648	45	52888	51	53253	17
49415	46	49629	18	49793	43	49985	43	51253	44	52650	45	52889	51	53254	17
49423	46	49630	18	49794	43	49986	43	51254	44	52651	45	52890	51	53255	28
49424	46	49631	18	49795	43	49987	43	51267	44	52653	45	52892	51	53256	28
49425	46	49635	67	49796	43	49988	43	51269	44	52658	45	52894	51	53259	28
49426	46	49636	67	49797	43	49989	43	51270	44	52661	45	52895	51	53260	28
49427	46	49637	67	49798	43	49990	43	51272	44	52662	45	52897	51	53327	45
49428	46	49638	67	49800	43	49991	43	51303	44	52680	45	52899	51	53335	45
49501	21	49639	67	49801	43	49992	43	51304	44	52681	45	52901	51	53336	45
49503	21	49640	67	49803	43	49995	43	51305	44	52682	45	52902	51	53337	45
49504	21	49641	67	49805	43	50965	43	51306	44	52683	45	52903	51	53338	45
49505	21	49642	67	49806	43	51000	82	51307	44	52684	45	53001	6	54001	8
49508	21	49643	67	49807	43	51001	82	51308	44	52685	45	53002	6	54002	8
49510	21	49644	67	49808	43	51002	82	51657	45	52686	45	53004	6	54004	8
49511	21	49645	67	49809	43	51003	82	51658	45	52714	45	53005	6	54005	8
49515	21	49646	67	49810	43	51004	82	51659	45	52716	45	53006	6	54011	8
49519	21	49647	67	49811	43	51005	82	51660	45	52717	45	53011	6	54012	8
49521	21	49649	67	49812	43	51006	82	51661	45	52718	45	53012	6	54014	8
49527	21	49650	67	49813	43	51007	82	51662	45	52720	45	53014	6	54015	8
49532	47	49652	16	49815	43	51008	82	51663	45	52726	45	53015	6	54021	8
49533	47	49653	16	49816	43	51015	44	52166	43	52746	45	53021	7	54022	8
49534	47	49682	41	49818	43	51016	44	52275	42	52747	45	53022	7	54024	8
49535	47	49683	41	49822	43	51017	44	52276	42	52748	45	53024	7	54025	8
49536	47	49684	41	49823	43	51018	44	52277	42	52749	45	53025	7	54031	8
49537	47	49686	16	49824	43	51019	44	52278	42	52750	45	53026	7	54032	8
49543	41	49687	16	49825	43	51020	44	52279	42	52762	45	53031	7	54034	8
49544	41	49688	16	49826	43	51051	44	52280	42	52773	45	53032	7	54035	8
49545	41	49689	16	49827	43	51052	44	52281	42	52774	45	53034	7	54270	36
49546	41	49690	16	49852	43	51053	44	52282	42	52775	45	53035	7	54271	36
49547	41	49692	16	49853	43	51054	44	52283	42	52811	45	53041	6	54272	36
49548	41	49693	16	49854	43	51055	44	52284	42	52814	45	53042	6	54273	36
49549	71	49694	16	49855	43	51056	44	52285	42	52815	45	53044	6	54274	36
49550	71	49698	16	49856	43	51057	44	52286	42	52819	45	53045	6	54275	36
49551	71	49699	16	49925	43	51058	44	52287	42	52820	45	53051	6	54276	36
49553	71	49700	16	49926	43	51059	44	52288	42	52822	45	53052	6	54277	36
49558	71	49701	16	49927	43	51060	44	52289	42	52823	45	53054	6	54280	25
49559	71	49714	73	49928	43	51062	44	52290	42	52861	51	53055	6	54281	25
49561	87	49716	73	49929	43	51063	44	52291	42	52862	51	53056	6	54282	25
49563	87	49750	41	49930	43	51064	44	52292	42	52863	51	53061	7	54283	25
49564	87	49751	41	49931	43	51065	44	52293	42	52864	51	53062	7	54284	25
49566	87	49752	41	49932	43	51066	44	52294	42	52865	51	53064	7	54285	25
49567	87	49753	41	49935	43	51069	44	52295	42	52866	51	53065	7	54286	25
49569	87	49761	43	49936	43	51070	44	52296	42	52867	51	53066	7	54287	25
49576	71	49762	43	49938	43	51071	44	52297	42	52868	51	53071	7	54288	25
49577	71	49763	43	49956	43	51072	44	52298	42	52869	51	53072	7	54290	25
49578	71	49764	43	49957	43	51073	44	52299	42	52870	51	53074	7	54291	25
49600	71	49765	43	49958	43	51074	44	52300	42	52871	51	53075	7	54292	25
49606	18	49766	43	49959	43	51231	44	52301	42	52872	51	53076	7	54293	25
49607	18	49767	43	49960	43	51232	44	52302	42	52873	51	53241	17	54294	25
49608	18	49776	43	49961	43	51233	44	52636	45	52874	51	53242	17	54295	25
49609	18	49777	43	49962	43	51234	44	52637	45	52875	51	53243	17	54296	25
49610	18	49778	43	49970	43	51235	44	52638	45	52876	51	53244	17	54297	25
49611	18	49779	43	49971	43	51236	44	52639	45	52877	51	53245	17	54298	25
49618	18	49780	43	49972	43	51239	44	52640	45	52878	51	53246	17	56012	12
49620	18	49781	43	49973	43	51240	44	52641	45	52879	51	53247	17	56013	12
49622	18	49782	43	49974	43	51242	44	52642	45	52885	51	53248	17	56014	12

INDEX

UPC #	Page #	UPC #	Page #	UPC #	Page #	UPC #	Page #	UPC #	Page #	UPC #	Page #	UPC #	Page #	UPC #	Page #
56015	12	59007	77	59223	54	59519	23	59625	23	59731	22	59927	23	60140	64
56016	12	59008	77	59224	54	59524	23	59626	23	59732	22	59940	23	60141	64
56017	12	59009	77	59225	54	59525	23	59627	23	59733	22	59941	23	60150	65
56018	12	59010	77	59226	54	59526	23	59628	23	59734	22	59942	23	60160	65
56019	12	59011	77	59227	54	59527	23	59633	23	59735	22	59943	23	60161	65
56022	12	59012	78	59228	54	59528	23	59634	23	59736	22	59944	23	60162	65
56024	12	59013	78	59229	54	59529	23	59635	23	59738	22	59945	23	60170	65
56025	12	59014	78	59230	54	59530	23	59636	23	59739	22	59946	23	60171	65
56026	12	59015	78	59231	54	59531	23	59637	23	59740	22	59947	23	60172	65
56027	12	59016	78	59232	54	59536	23	59638	23	59741	22	59950	23	60180	65
56028	12	59017	78	59233	54	59537	23	59639	23	59742	22	59951	23	60181	65
56029	12	59018	78	59234	54	59538	23	59640	23	59743	22	59952	23	60182	65
58002	76	59020	78	59235	54	59539	23	59645	23	59744	22	59953	23	60190	65
58004	76	59021	78	59236	54	59540	23	59646	23	59745	22	59954	23	60195	65
58006	76	59022	78	59237	54	59541	23	59647	23	59746	22	59955	23	60196	65
58007	76	59023	79	59238	54	59542	23	59648	23	59747	22	59956	23	60200	66
58008	76	59024	79	59239	54	59543	23	59649	23	59748	22	59957	23	60201	66
58011	76	59025	76	59240	54	59560	23	59650	23	59749	22	59960	23	60202	66
58012	76	59033	77	59241	54	59561	23	59651	23	59750	22	59961	23	60203	66
58013	77	59035	78	59242	54	59562	23	59652	23	59751	22	59962	23	60204	66
58016	77	59038	78	59243	54	59563	23	59668	23	59752	22	59963	23	60205	66
58017	77	59040	78	59244	54	59564	23	59669	23	59753	22	59964	23	60206	66
58019	77	59045	79	59245	54	59565	23	59670	23	59754	22	59965	23	60207	66
58021	77	59050	87	59246	54	59566	23	59671	23	59801	19	59966	23	60208	66
58023	77	59051	87	59271	54	59567	23	59672	23	59802	19	59967	23	60209	66
58025	77	59052	87	59272	54	59568	23	59673	23	59803	19	60001	62	60210	66
58026	77	59053	87	59273	54	59569	23	59674	23	59804	19	60006	62	60211	66
58028	77	59054	87	59274	54	59570	23	59675	23	59805	19	60011	62	60225	66
58029	77	59055	87	59275	54	59571	23	59676	23	59806	19	60012	62	60226	66
58031	78	59056	87	59276	54	59572	23	59677	23	59807	19	60013	62	60227	66
58033	78	59057	87	59277	54	59573	23	59678	23	59808	19	60014	62	60228	66
58034	78	59059	79	59278	54	59574	23	59679	23	59809	19	60020	62	60229	66
58037	78	59060	55	59279	54	59587	23	59680	23	59810	19	60025	62	60230	66
58038	78	59061	55	59283	54	59588	23	59681	23	59811	19	60035	62	60250	67
58039	78	59062	55	59284	54	59589	23	59682	23	59812	19	60037	62	60500	62
58040	78	59063	55	59285	54	59590	23	59683	23	59900	23	60040	62	60501	62
58041	79	59081	76	59286	54	59591	23	59696	23	59901	23	60041	62	60502	62
58042	79	59084	77	59287	54	59592	23	59697	23	59902	23	60052	62	60503	62
58043	79	59085	77	59288	54	59593	23	59698	23	59903	23	60053	62	60505	62
58044	79	59100	40	59306	54	59594	23	59699	23	59904	23	60060	63	60514	62
58045	79	59101	40	59307	54	59595	23	59700	23	59905	23	60065	63	60515	62
58046	79	59109	32	59308	54	59596	23	59701	23	59906	23	60070	63	60520	62
58047	79	59110	32	59503	22	59597	23	59702	23	59907	23	60076	63	60521	62
58048	78	59200	55	59504	22	59598	23	59703	23	59910	23	60090	63	60522	62
58049	78	59201	55	59505	22	59599	23	59704	23	59911	23	60091	63	60523	62
58050	78	59202	55	59506	22	59600	23	59705	23	59912	23	60100	63	60524	62
58054	86	59203	55	59507	22	59608	22	59706	23	59913	23	60103	63	60525	62
58057	86	59204	55	59508	22	59609	22	59707	23	59914	23	60104	63	60535	63
58058	86	59205	55	59509	22	59610	22	59708	23	59915	23	60105	63	60536	63
58059	86	59206	55	59510	22	59611	22	59709	23	59916	23	60106	63	60537	63
58060	86	59207	55	59511	22	59612	22	59717	23	59917	23	60110	63	60538	63
59000	76	59208	55	59512	23	59614	22	59718	23	59920	23	60112	63	60539	63
59001	77	59209	55	59513	23	59615	22	59719	23	59921	23	60120	63	60540	63
59002	77	59210	55	59514	23	59616	22	59722	23	59922	23	60125	63	60541	63
59003	77	59211	55	59515	23	59621	23	59723	23	59923	23	60130	64	60542	63
59004	77	59220	54	59516	23	59622	23	59728	22	59924	23	60131	64	60560	63
59005	77	59221	54	59517	23	59623	23	59729	22	59925	23	60132	64	60561	63
59006	77	59222	54	59518	23	59624	23	59730	22	59926	23	60133	67	60562	63

INDEX

UPC #	Page #	UPC #	Page #	UPC #	Page #	UPC #	Page #	UPC #	Page #	UPC #	Page #	UPC #	Page #	UPC #	Page #
60563	63	61083	52	61507	52	61808	52	62502	70	70007	47	70111	32	72053	17
60564	63	61084	52	61508	52	61809	52	62505	70	70008	47	70112	33	72054	17
60575	64	61085	52	61509	52	61810	52	62508	70	70009	47	70113	33	72055	17
60576	64	61087	52	61510	52	61811	52	62509	70	70010	47	70114	28	72056	17
60577	64	61089	53	61511	52	61812	52	62510	70	70011	47	70115	28	72057	17
60578	64	61090	53	61513	52	61813	52	62511	70	70012	47	70120	16	72058	17
60579	64	61091	53	61514	52	61814	52	62522	70	70013	47	70121	16	72059	17
60580	64	61092	53	61515	52	61815	52	62524	70	70014	47	70122	16	72070	17
60590	64	61093	53	61516	52	61816	52	62526	70	70015	47	70123	16	72071	17
60591	64	61095	53	61517	52	62028	68	62604	68	70017	47	70124	16	72072	17
60592	64	61117	53	61519	52	62142	69	62608	68	70018	47	70125	16	72073	17
60593	64	61118	53	61520	52	62146	69	62613	68	70019	47	70130	88	72074	17
60650	65	61119	53	61521	52	62161	69	62614	68	70022	47	70131	88	72075	17
60651	65	61120	53	61522	52	62226	70	62621	68	70023	47	70132	88	72080	17
60665	65	61121	53	61523	52	62319	68	62625	68	70024	47	70133	88	72082	17
60728	53	61123	53	61525	52	62321	68	62654	69	70025	47	70134	88	72083	17
60729	53	61125	53	61526	52	62323	68	62658	69	70026	47	70135	88	72084	17
60730	53	61126	53	61527	52	62325	68	62668	70	70029	47	70136	88	72085	17
60731	53	61127	53	61528	52	62328	68	62700	70	70030	47	70137	88	72106	58
60732	53	61128	53	61529	52	62329	68	63062	46	70031	47	70139	88	72107	58
61009	52	61129	53	61531	52	62330	68	63063	46	70032	47	70140	88	72108	58
61010	52	61131	53	61532	52	62333	68	63064	46	70033	47	70141	88	72109	58
61011	52	61133	53	61533	52	62350	68	63065	46	70034	47	70143	88	72110	58
61012	52	61134	53	61534	52	62353	68	63066	46	70035	47	70144	88	72111	58
61013	52	61135	53	61535	52	62357	68	63067	46	70036	47	70145	88	72112	58
61015	52	61136	53	61543	52	62377	68	63068	46	70037	47	70148	88	72113	58
61017	52	61137	53	61544	52	62379	68	63069	46	70038	55	70149	88	72114	58
61018	52	61139	53	61545	52	62381	68	63070	46	70040	55	70150	88	72116	58
61019	52	61178	53	61546	52	62383	68	63071	46	70042	55	70151	88	72117	58
61020	52	61179	53	61547	52	62386	68	63072	46	70046	55	70153	88	72118	58
61021	52	61180	53	61555	52	62387	68	63073	46	70047	55	70154	88	72119	58
61023	52	61181	53	61556	52	62391	68	63074	46	70048	55	70155	88		
61025	52	61182	53	61557	52	62404	69	63075	46	70049	55	70156	88		
61026	52	61184	53	61558	52	62407	69	63076	46	70050	55	70157	88		
61027	52	61191	53	61559	52	62408	69	63077	46	70051	55	70160	88		
61028	52	61192	53	61561	53	62410	69	63078	46	70052	55	70185	16		
61029	52	61193	53	61562	53	62412	69	63079	46	70053	55	70186	16		
61031	52	61194	53	61563	53	62413	69	63080	46	70054	55	70187	16		
61033	52	61195	53	61564	53	62425	69	63081	46	70057	57	70188	16		
61034	52	61197	53	61565	53	62426	69	63082	46	70058	57	70189	16		
61035	52	61249	53	61579	53	62427	69	63083	46	70059	57	70190	16		
61036	52	61250	53	61580	53	62428	69	63084	46	70062	57	70401	73		
61037	52	61251	53	61581	53	62430	69	63085	46	70063	57	70407	73		
61039	52	61252	53	61582	53	62440	69	63086	46	70064	57	70428	73		
61041	52	61253	53	61583	53	62442	69	63087	46	70068	57	70429	73		
61042	52	61255	53	61633	53	62443	69	63088	46	70069	57	70430	73		
61043	52	61262	53	61634	53	62446	69	63089	46	70070	57	70432	73		
61044	52	61263	53	61635	53	62447	69	63090	46	70086	57	70447	73		
61045	52	61264	53	61636	53	62448	69	63091	46	70087	57	70449	73		
61047	52	61265	53	61637	53	62449	69	63092	46	70088	57	70456	73		
61057	52	61266	53	61800	53	62462	69	63095	46	70090	57	71151	49		
61058	52	61268	53	61801	53	62463	69	63098	46	70091	57	72008	88		
61059	52	61291	53	61802	53	62465	69	70000	47	70092	57	72009	88		
61060	52	61292	53	61803	53	62468	69	70001	47	70105	32	72013	88		
61061	52	61293	53	61804	53	62469	69	70002	47	70107	32	72018	88		
61063	52	61294	53	61805	53	62478	69	70003	47	70108	32	72050	17		
61081	52	61295	53	61806	52	62479	69	70004	47	70109	32	72051	17		
61082	52	61297	53	61807	52	62480	69	70006	47	70110	33	72052	17		



Flap Discs

Various Sizes & Specifications

Resin Bonded Abrasives

Grinding & Cutting Wheels

Paper Discs

Disc Rolls, Hook & Loop, PSA

Coated Abrasive Belts

Narrow & Wide Belts

- Stock
- Made-to-order

Precision Grinding

Vitrified Abrasives

- Stock
- Made-to-order

NEW PREMIUM PRODUCTS



eXtreme
Cutting Wheels

page 25



eXtreme
Grinding Wheels

page 36

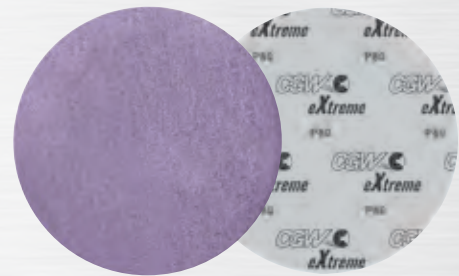

eXtreme
Paper Discs

page 42



OUR COMPANY

- Established since 1956
- Same day/next day shipping
- Broad product offering
- CGW EXPRESS made-to-order belts



Where Quality, Performance & Value – Come Together!

7525 North Oak Park Avenue, Niles, IL 60714 | phone: 800.447.4248 | orders@cgwabrasives.com