

LOC-LINE[®]

THE ORIGINAL MODULAR HOSE SYSTEM

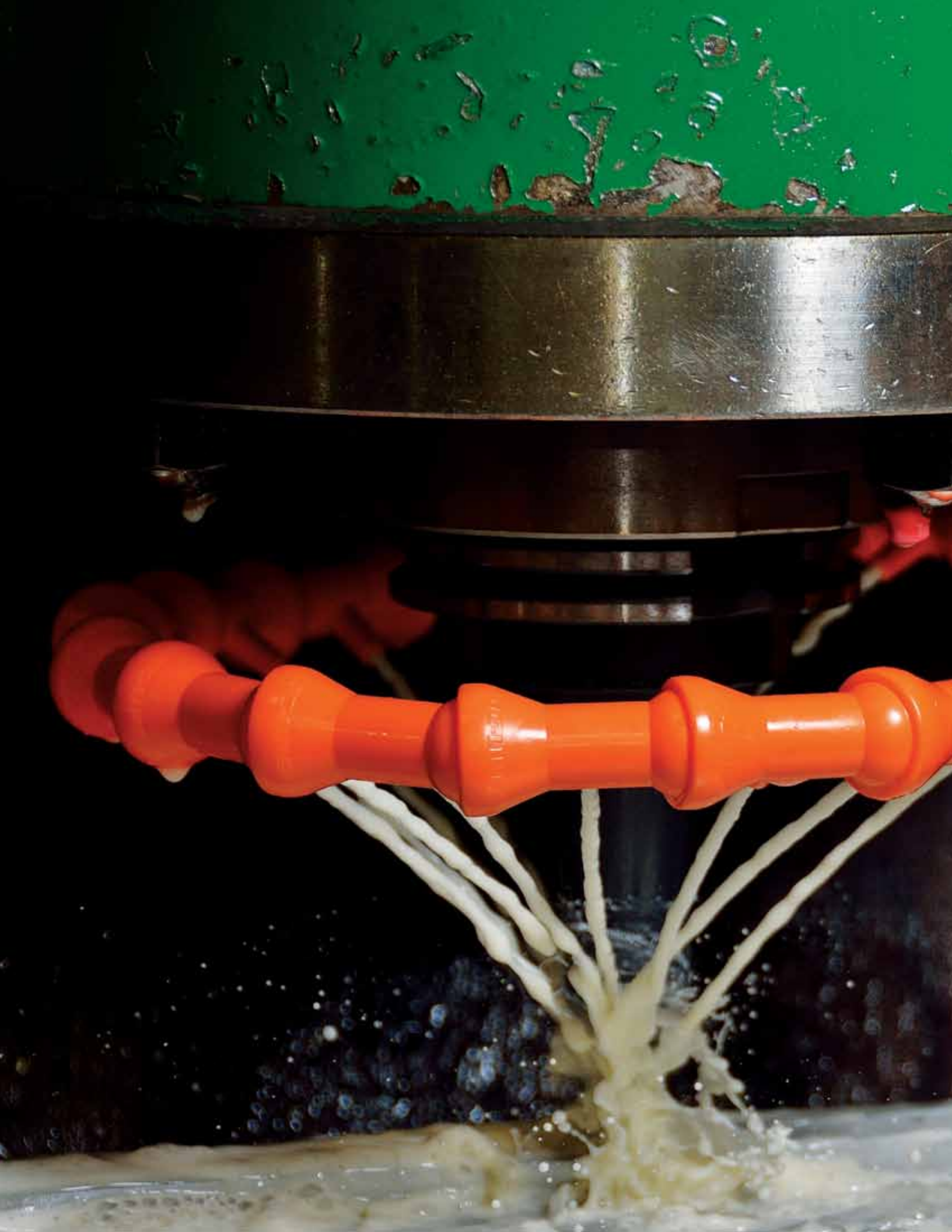





CONTENTS

THE LOC-LINE® SYSTEM	4
CUSTOMIZED SOLUTIONS	5
1/4" SYSTEM	6
1/2" SYSTEM	10
3/4" SYSTEM	14
QUICK-SET SHIELD™	15
2-1/2" SYSTEM	16
A WORLD OF POSSIBILITIES	18
TECHNICAL INFORMATION	20
PRODUCT INDEX	22



THE LOC-LINE® SYSTEM: ENDLESS COMBINATIONS, OUTSTANDING RESULTS

LOC-LINE® is the original modular hose system. Four hose diameters and a multitude of nozzles, fittings and accessories allow for customized solutions suitable for a wide variety of industrial and commercial applications.



Loc-Line® was the answer to an age old problem specific to the machine tool industry: How to easily apply liquid coolant at the point of contact with the cutting tool and the target metal.

The design was simple and elegant. A ball and socket assembly with just enough friction to create a hose that offered unlimited positioning, full coolant flow, would not fatigue, stayed in position and could be customized to the job. Loc-Line was and still is the number one coolant delivery answer for machinists across the globe. Over the years, the adjustable hose concept has expanded way beyond its first task of coolant delivery.



Continued growth has seen the use of Loc-Line expanding into the electronic, scientific, graphic arts and woodworking industries. Almost any situation that requires precise yet adjustable directional flow of fluid, air, vacuum and third arm positioning will find Loc-Line to be the perfect solution. With four hose diameters; 1/4", 1/2", 3/4" and 2 1/2" to accommodate many applications and environments, our customers have become as varied as our hose combinations.



- Loc-Line's unique ball and socket design is fully hand adjustable in both position and length.
- Loc-Line has no internal positioning rod that can break or restrict fluid flow.
- Bending doesn't decrease the inside diameter and it won't kink or fatigue like copper tubing.
- Repeated positioning is easy and it will stay in position without any springback. Creep due to machine vibration is eliminated.
- Unlike metal hoses, Loc-Line won't damage machine tool cutters if contact occurs.
- Loc-Line is manufactured in a premium grade acetal copolymer material which is chemically resistant to petroleum products, coolants and most common chemicals. Selected parts are also available in an acid resistant polyester.
- Loc-Line is electrically non-conductive. It's ideal for use as an EDM flushing hose.

MY HOSE DRAINS WHILE I CHANGE MY PALLET OR TOOL. HOW CAN I STOP THIS?

Use our **Check Valves** to eliminate dripping while you change your pallet or tool.

HOW DO I PUT A CONNECTOR ON BOTH ENDS? Use a **Double Socket** to reverse the direction of the hose and add the second connector.

HOW DO I ADD HOSE SUPPORT MID-WAY IN THE COOLANT LINE? Use our **T Fitting** which features a mounting boss.

HOW DO I GET MY NOZZLE TO RUN COOLANT PARALLEL TO MY WORK? Use our **Swivel Nozzles** with an adjustable spray head featuring a 40 degree range of motion over the flared base. The evenly spaced holes create an even distribution of coolant or air.

HOW CAN I MAKE QUICK TURNS? Use our **90 Degree Nozzles** for a quick turn close to the cutter. 90 Nozzles can also be assembled directly on the NPT for tight spaces.

MY COOLANT HEADS TO THE EDGES, HOW CAN I IMPROVE THE DISTRIBUTION? Use our **Straight Flow Nozzles** designed with a wider center and straight edges to create a uniform flow over the width of the nozzles.

HOW DO REDUCE DOWN FROM A LARGER SYSTEM? Use our **Adapters** to reduce down from 3/4" or 1/2" hose systems.

HOW CAN I ATTACH A NON LOC-LINE NOZZLE? Use our **1/4" Socket X 1/8 FNPT** to thread in your specialty nozzle.

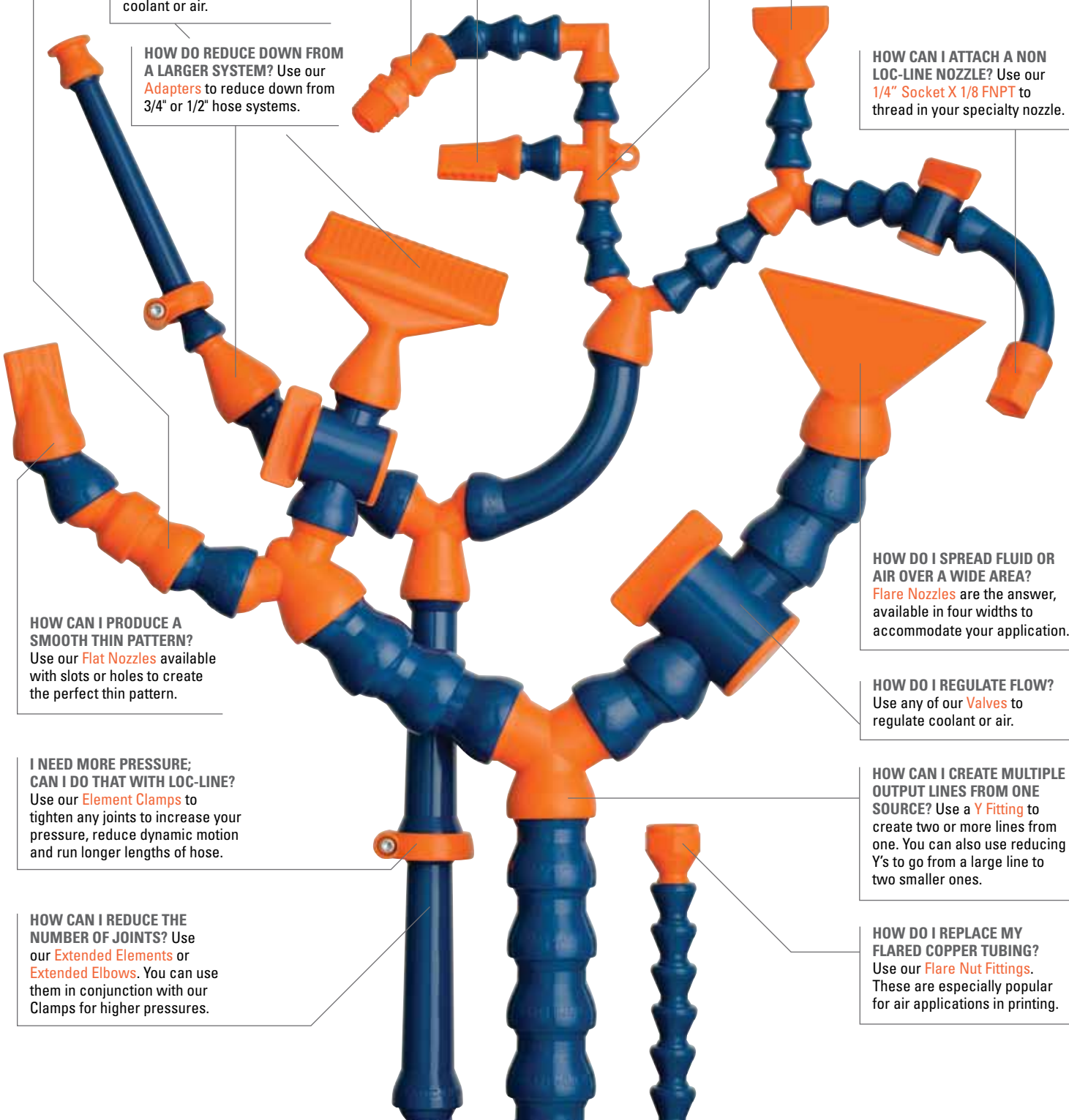

HOW CAN I PRODUCE A SMOOTH THIN PATTERN? Use our **Flat Nozzles** available with slots or holes to create the perfect thin pattern.

HOW DO I SPREAD FLUID OR AIR OVER A WIDE AREA? **Flare Nozzles** are the answer, available in four widths to accommodate your application.

I NEED MORE PRESSURE; CAN I DO THAT WITH LOC-LINE? Use our **Element Clamps** to tighten any joints to increase your pressure, reduce dynamic motion and run longer lengths of hose.

HOW DO I REGULATE FLOW? Use any of our **Valves** to regulate coolant or air.

HOW CAN I REDUCE THE NUMBER OF JOINTS? Use our **Extended Elements** or **Extended Elbows**. You can use them in conjunction with our **Clamps** for higher pressures.

HOW CAN I CREATE MULTIPLE OUTPUT LINES FROM ONE SOURCE? Use a **Y Fitting** to create two or more lines from one. You can also use reducing Y's to go from a large line to two smaller ones.

HOW DO I REPLACE MY FLARED COPPER TUBING? Use our **Flare Nut Fittings**. These are especially popular for air applications in printing.



1/4-INCH SYSTEM

KITS

1/4" HOSE KIT

40413

- (2) 5 3/4" Long Segments
- (1) 1/4" Round Nozzle
- (1) 1/8" Round Nozzle
- (1) 1/16" Round Nozzle
- (1) 1/4" NPT Connector
- (1) 1/8" NPT Connector

• Assembled Length = 13"



1/4" FLARED TUBING REPLACEMENT PACK

40452

- (8) 5 3/4" Long Segments
- (1) 1" Flare Nozzle
- (4) 3/8" Flare Nut Adapters
- (4) 1/8" Round Nozzles
- (4) 1/4" Round Nozzles



HAAS LATHE ADAPTER KIT

40475

- (4) Haas Short Adapters
- (4) Haas 2" Adapters
- (2) Flat 5-Hole Nozzles
- (2) Flat Slot 60 Nozzles
- (2) 1/8" 90° Nozzles
- (2) 1/4" 90° Nozzles
- (2) 1/8" Round Nozzles
- (2) 1/4" Round Nozzles
- (2) Straight Flow Nozzles
- (4) Element Clamps w/ screws
- (8) Elements
- (1) 1/4" Assembly Pliers



15 MM LATHE ADAPTER KIT

40476

- (4) 15 mm Short Adapters
- (4) 15 mm x 2" Adapters
- (2) Flat 5 Hole Nozzles
- (2) Flat Slot 60 Nozzles
- (2) 1/8" 90° Nozzles
- (2) 1/4" 90° Nozzles
- (2) 1/8" Round Nozzles
- (2) 1/4" Round Nozzles
- (2) Straight Flow Nozzles
- (4) Element Clamps w/ screws
- (8) Elements
- (1) 1/4" Assembly Pliers



1/4" EXTENDED ELBOW KIT

40472

- (4) Extended Elbows
- (4) Element Clamps w/ screws
- (1) 1/8" NPT Connector
- (1) 1/4" NPT Connector
- (1) 1/16" Round Nozzle
- (1) 1/8" Round Nozzle
- (1) 1/4" Round Nozzle



1/4" MIXED ELEMENT KIT

40473

- (2) Extended Elbows
- (2) Extended Elements
- (4) Element Clamps w/ screws
- (1) 1/8" NPT Connector
- (1) 1/4" NPT Connector
- (1) 1/16" Round Nozzle
- (1) 1/8" Round Nozzle
- (1) 1/4" Round Nozzle



1/4" EXTENDED ELBOWS WITH CLAMPS

40474

- (4) Extended Elbows
- (4) Element Clamps w/ screws



1/4" EXTENDED ELEMENT KIT WITH CLAMPS

41475

- (4) 1/4" Extended Elements
- (4) 1/4" Element Clamps w/ screws



1/4" CIRCLE FLOW NOZZLE KIT

41479

- Assembled with:
- (15) 1/4" Side Flow Nozzles
- (1) 1/4" End Cap

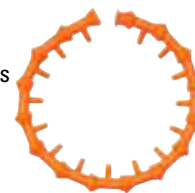

Overall Length = 17.56"

PLIERS

1/4" HOSE ASSEMBLY PLIERS

78001

- (1) 1/4" Pliers

78003

- (1) 1/4" Pliers
- (1) 1/2" Pliers



• 1/4" Assembly pliers will not assemble part numbers 41411 or 49431

HOSES

1/4" HOSE

41401

- (2) 5 3/4" Long Segments*

49420 ■-BLK ■-G (55) Segments*, Bulk 25-ft

49419 ■-BLK ■-G (1) 5 ft Coil

49421 ■-BLK ■-G (1) 50 ft Coil

*1 Segment = 10 Elements



1/4" EXTENDED ELEMENT

41476

- (4) Extended Elements
- 49445** ■-BLK ■-G (20) Extended Elements



1/4" EXTENDED ELBOW

41491

- (4) Extended Elbows
- 49457** ■-BLK ■-G (20) Extended Elbows



HOW TO ORDER BLACK OR GRAY LOC-LINE:

■-BLK Part can be ordered in Black.

Add suffix to part number when ordering, ie: **49421-BLK**

■-G Part can be ordered in Gray.

Add suffix to part number when ordering, ie: **49421-G**

NOZZLES

1/4" NOZZLE-RAMA PACK

41490 
 (16) Includes 1 nozzle from each of these packages:
 41402, 41403, 41404, 41407, 41470, 41471, 41472, 41473, 41481, 41482, 41483, 41484, 41485, 41486 41488, 41489



1/4" 90° NOZZLE KIT

41474 
 (1) 1/16" 90° Nozzle
 (1) 1/8" 90° Nozzle
 (1) 1/4" 90° Nozzle
 (1) 1/4" 90° Spray Bar Nozzle







1/4" FLAT NOZZLE ASSORTMENT PACK

41487 
 (1) Flat Slot 40 Nozzle
 (1) Flat Slot 60 Nozzle
 (1) Flat 5 Hole Nozzle
 (1) Flat 7 Hole Nozzle







1/16" ROUND NOZZLE

41402 
 (4) Round Nozzles
49422   **-BLK**  **-G**
 (50) Round Nozzles







1/8" ROUND NOZZLE

41403 
 (4) Round Nozzles
49423   **-BLK**  **-G**
 (50) Round Nozzles



1/4" ROUND NOZZLE

41404 
 (4) Round Nozzles
49424   **-BLK**  **-G**
 (50) Round Nozzles



1" FLARE NOZZLE

41407 
 (2) Flare Nozzles
49427   **-BLK**  **-G**
 (20) Flare Nozzles





1" STRAIGHT FLOW NOZZLE

41489 
 (2) Straight Flow Nozzles
49456   **-BLK**  **-G**
 (20) Straight Flow Nozzles







1/16" 90° NOZZLE

41470 
 (4) 90° Nozzles
49439   **-BLK**  **-G**
 (20) 90° Nozzles







1/8" 90° NOZZLE

41471 
 (4) 90° Nozzles
49440   **-BLK**  **-G**
 (20) 90° Nozzles







1/4" 90° NOZZLE

41472 
 (4) 90° Nozzles
49441   **-BLK**  **-G**
 (20) 90° Nozzles



1/4" 90° SPRAY BAR NOZZLE

41473 
 (2) 90° Spray Bar Nozzles
49442   **-BLK**  **-G**
 (20) 90° Spray Bar Nozzles



1/4" FLAT SLOT 40 NOZZLE

41483 
 (4) Flat Slot Nozzles
49451   **-BLK**  **-G**
 (20) Flat Slot Nozzles
 0.040" Slot height







1/4" FLAT SLOT 60 NOZZLE

41484 
 (4) Flat Slot Nozzles
49452   **-BLK**  **-G**
 (20) Flat Slot Nozzles
 0.060" Slot height







1/4" FLAT 5-HOLE NOZZLE

41485 
 (4) Flat 5-Hole Nozzles
49453   **-BLK**  **-G**
 (20) Flat 5-Hole Nozzles
 0.060" Hole diameter



1/4" FLAT 7-HOLE NOZZLE

41486 
 (4) Flat 7-Hole Nozzles
49454   **-BLK**  **-G**
 (20) Flat 7-Hole Nozzles
 0.040" Hole diameter



1/4" SIDE FLOW NOZZLE

41478 
 (4) Side Flow Nozzles
49443   **-BLK**  **-G**
 (20) Side Flow Nozzles



1/4" SWIVEL NOZZLE 40

41481 
 (2) Swivel Nozzles
49449   **-BLK**  **-G**
 (20) Swivel Nozzles
 0.040" Hole diameter



1/4" SWIVEL NOZZLE 60

41482 
 (2) Swivel Nozzles
49450   **-BLK**  **-G**
 (20) Swivel Nozzles
 0.060" Hole diameter







2 1/2" SWIVEL NOZZLE 75

41488 
 (2) Swivel Nozzles
49455   **-BLK**  **-G**
 (20) Swivel Nozzles
 0.075" Hole diameter



VALVES

1/4" MALE NPT VALVE

21192 
 (2) Male NPT Valves
29452   **-BLK**  **-G**
 (10) Male NPT Valves







1/4" IN-LINE VALVE

21194 
 (2) In-Line Valves
29454   **-BLK**  **-G**
 (10) In-Line Valves







1/4" FEMALE NPT VALVE

21193 
 (2) Female NPT Valves
29453   **-BLK**  **-G**
 (10) Female NPT Valves



IN-LINE CHECK VALVE





21191 
 (2) Check Valves
29451   **-BLK**  **-G**
 (10) Check Valves



1/4-INCH SYSTEM

CONNECTORS

1/8" NPT CONNECTOR

- 41405**  (4) NPT Connectors
49425   -BLK  -G (50) NPT Connectors

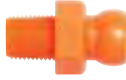





1/8" BSPT* CONNECTOR

- 41417**  (4) BSPT Connectors
49437   -BLK  -G (50) BSPT Connectors



* British Standard Pipe Thread

1/4" NPT CONNECTOR

- 41406**  (4) NPT Connectors
49426   -BLK  -G (50) NPT Connectors

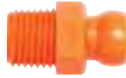

1/4" BSPT* CONNECTOR

- 41418**  (4) BSPT Connectors
49438   -BLK  -G (50) BSPT Connectors







* British Standard Pipe Thread

3/8" SAE FLARE NUT ADAPTER

- 41412**  (4) Flare Nut Adapters
49432   -BLK  -G (20) Flare Nut Adapters







1/4" SAE FLARE NUT ADAPTER

- 41414**  (4) Flare Nut Adapters
49434   -BLK  -G (20) Flare Nut Adapters







15 MM "SHORT" LATHE ADAPTER

- 41492**  (4) Lathe Adapters
49458   -BLK  -G (20) Lathe Adapters







15 MM x 2" LATHE ADAPTER

- 41493**  (4) Lathe Adapters
49459   -BLK  -G (20) Lathe Adapters







HAAS "SHORT" LATHE ADAPTER

- 41494**  (4) Lathe Adapters
49460   -BLK  -G (20) Lathe Adapters







HAAS x 2" LATHE ADAPTER

- 41495**  (4) Lathe Adapters
49461   -BLK  -G (20) Lathe Adapters







ACCESSORIES

1/4" ELEMENT CLAMP

- 41477**  (4) Element Clamps
 w/ Torx® T-15 screws
49446   -BLK  -G (20) Element Clamps
 w/ Torx® T-15 screws







1/4" Y FITTING

- 41408**  (2) Y Fittings
49428   -BLK  -G (20) Y Fittings







1/4" DOUBLE SOCKET

- 41409**  (4) Double Sockets
49429   -BLK  -G (20) Double Sockets





1/4" SOCKET X 1/8" FNPT

- 41411**  (4) 1/4" Socket X 1/8" FNPT
49431   -BLK  -G (20) 1/4" Socket X 1/8" FNPT







1/4" ELBOW FITTING

- 41415**  (2) Elbow Fittings
49435   -BLK  -G (20) Elbow Fittings







1/4" T FITTING

- 41416**  (2) T Fittings
49436   -BLK  -G (20) T Fittings



1/4" END CAP

- 41480**  (4) End Caps
49447   -BLK  -G (20) End Caps



HOW TO ORDER BLACK OR GRAY LOC-LINE:

 -BLK Part can be ordered in Black.

Add suffix to part number when ordering, ie: **49421-BLK**

 -G Part can be ordered in Gray.

Add suffix to part number when ordering, ie: **49421-G**

MANIFOLDS

MAGNETIC BASE MANIFOLD SUPER KIT

40480

- (8) 5/4" Long Segments
- (5) 1/4" MNPT Valves
- (2) 1" Flare Nozzles
- (2) 1/4" Round Nozzles
- (2) 1/8" Round Nozzles
- (2) 1/16" Round Nozzles
- (1) Mag. Base Manifold
- (3) 1/4" Plugs
- (1) 1/4" Barb Fitting

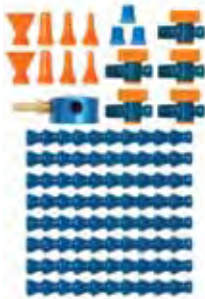

1/4" MODULAR MANIFOLD

21199

- (3) 1/4" T Fittings
- (1) 1/4" Elbow Fitting
- (1) 1/4" Manifold Bracket
- (3) Mounting Screws



1/4" TOTAL FLOW CONTROL MANIFOLD

21198

- (1) 1/4" Modular Manifold
- (5) 1/4" In-Line Valves

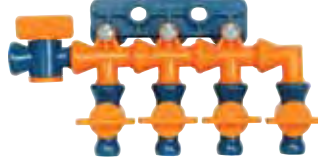

1/4" MODULAR MANIFOLD BRACKET

21195

- (2) Brackets



MAGNETIC BASE MANIFOLD KIT

40463

- (2) 5/4" Long Segments
- (1) 1/4" MNPT Valve
- (1) 1" Flare Nozzle
- (1) 1/4" Round Nozzle
- (1) 1/8" Round Nozzle
- (1) 1/16" Round Nozzle
- (1) Mag. Base Manifold
- (3) 1/4" Plugs
- (1) 1/4" Barb Fitting

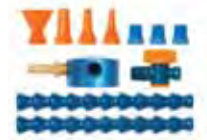

MAGNETIC BASE MANIFOLD

40400

- (1) Magnetic Base Manifold
- (3) 1/4" Plugs
- (1) 1/4" Barb Fitting



25 LB. Holding Force

ACID RESISTANT

1/4" ACID RESISTANT HOSE KIT

45463

- (2) 5/4" Long Segments
- (1) 1/4" Nozzle
- (1) 1/8" Nozzle
- (1) 1/16" Nozzle
- (1) 1/4" NPT Connector
- (1) 1/8" NPT Connector



1/4" ACID RESISTANT HOSE

45401

- (2) 5/4" Long Segments



46420

- (55) Segments, Bulk 25-ft



46419

- (1) 5 ft Coil



46421

- (1) 50 ft Coil



1/16" ACID RESISTANT NOZZLE

45402

- (4) Round Nozzles



46422

- (50) Round Nozzles

1/8" ACID RESISTANT NOZZLE

45403

- (4) Round Nozzles



46423

- (50) Round Nozzles

1/4" ACID RESISTANT NOZZLE

45404

- (4) Round Nozzles



46424

- (50) Round Nozzles

1" ACID RESISTANT FLARE NOZZLE

45407

- (2) Flare Nozzles



46427

- (20) Flare Nozzles

1/8" ACID RESISTANT NPT CONNECTOR

45405

- (4) NPT Connectors

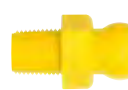

46425

- (50) NPT Connectors

1/4" ACID RESISTANT NPT CONNECTOR

45406

- (4) NPT Connectors



46426

- (50) NPT Connectors

1/4" ACID RESISTANT Y FITTING

45408

- (2) Y Fittings



46428

- (20) Y Fittings

1/4" ACID RESISTANT DOUBLE SOCKET

45409

- (4) Double Sockets



46429

- (20) Double Sockets

1/4" SOCKET X 1/8" FNPT ACID RESISTANT

45411

- (4) 1/4" Socket X 1/8" FNPT



46431

- (20) 1/4" Socket X 1/8" FNPT

1/4" ACID RESISTANT ELBOW FITTING

45415

- (2) Elbow Fittings



46435

- (20) Elbow Fittings

1/4" ACID RESISTANT T FITTING

45416

- (2) T Fittings



46436

- (20) T Fittings

1/4" ACID RESISTANT SWIVEL NOZZLE 40

45481

- (2) Swivel Nozzles



46449

- (20) Swivel Nozzles

1/4" ACID RESISTANT SWIVEL NOZZLE 60

45482

- (2) Swivel Nozzles



46450

- (20) Swivel Nozzles



1/2-INCH SYSTEM

KITS

1/2" HOSE KIT

50813

- (2) 5 1/2" Long Segments
- (1) 1/4" Round Nozzle
- (1) 3/8" Round Nozzle
- (1) 1/2" Round Nozzle
- (1) 3/8" NPT Connector
- (1) 1/2" NPT Connector

• Assembled Length = 13"



1/2" EXTENDED ELBOWS WITH CLAMPS

50874

- (4) Extended Elbows
- (4) Element Clamps w/ screws



1/2" EXTENDED ELBOW KIT

50872

- (4) Extended Elbows
- (4) Element Clamps w/ screws



1/2" MIXED ELEMENT KIT

50873

- (1) 3/8" NPT Connector
- (1) 1/2" NPT Connector
- (1) 1/4" Round Nozzle
- (1) 3/8" Round Nozzle
- (1) 1/2" Round Nozzle
- (2) Extended Elbows
- (2) Extended Elements
- (4) Element Clamps w/ screws



1/2" EXTENDED ELEMENT KIT W/ CLAMPS

51835

- (4) 1/2" Extended Elements
- (4) Element Clamps w/ screws



1/2" CIRCLE FLOW NOZZLE KIT

51837

- Assembled with (15) 1/2" Side Flow Nozzles
- (1) 1/2" End Cap

• Overall Length = 24.375"



PLIERS

1/2" HOSE ASSEMBLY PLIERS

78002

- (1) 1/2" pliers



78003

- (1) 1/4" pliers
- (1) 1/2" pliers

HOW TO ORDER BLACK OR GRAY LOC-LINE:

■-BLK Part can be ordered in Black.

Add suffix to part number when ordering, ie: 59861-BLK

■-G Part can be ordered in Gray.

Add suffix to part number when ordering, ie: 59861-G

HOSES

1/2" HOSE

51801

- (2) 5 1/2" Long Segments

59860 ■-BLK ■-G

- (59) Segments, Bulk 25 ft

59859 ■-BLK ■-G

- (1) 5 ft Coil

59861 ■-BLK ■-G

- (1) 50 ft Coil

• 1 Segment = 6 Elements



1/2" EXTENDED ELEMENT

51833

- (4) Extended Elements

59883 ■-BLK ■-G

- (20) Extended Elements



1/2" EXTENDED ELBOW

51896

- (4) Extended Elbows

59899 ■-BLK ■-G

- (20) Extended Elbows



NOZZLES

1/2" NOZZLE-RAMA PACK

51849 
 (16) Includes 1 nozzle from each of these packages:
 51802, 51803, 51806, 51807, 51809, 51828, 51829, 51830, 51831, 51840, 51841 51842, 51843, 51845, 51847, 51848,



1/2" 90° NOZZLE KIT

51832 
 (1) 1/16" Round Nozzle
 (1) 1/8" Round Nozzle
 (1) 1/4" Round Nozzle
 (1) 1/4" Spray Bar Nozzle









1/2" FLAT NOZZLE ASSORTMENT

51844 
 (1) Flat Slot 80 Nozzle
 (1) Flat Slot 125 Nozzle
 (1) Flat 5-Hole Nozzle
 (1) Flat 7-Hole Nozzle









1/4" ROUND NOZZLE FOR 1/2"

51806 
 (4) Round Nozzles
59866     
 (50) Round Nozzles









3/8" ROUND NOZZLE

51802 
 (4) Round Nozzles
59862     
 (50) Round Nozzles









1/2" ROUND NOZZLE

51803 
 (4) Round Nozzles
59863     
 (50) Round Nozzles









1/4" 90° NOZZLE

51828 
 (4) 90° Nozzles
59878     
 (20) 90° Nozzles





3/8" 90° NOZZLE

51829 
 (4) 90° Nozzles
59879     
 (20) 90° Nozzles



1/2" 90° NOZZLE

51830 
 (4) 90° Nozzles
59880    
 (20) 90° Nozzles



1/2" 90° SPRAY BAR NOZZLE

51831 
 (2) 90° Spray Bar Nozzles
59881    
 (20) 90° Spray Bar Nozzles



1/4" FLARE NOZZLE

51807 
 (2) Flare Nozzles
59867    
 (20) Flare Nozzles







2 1/2" FLARE NOZZLE

51809 
 (2) Flare Nozzles
59871    
 (20) Flare Nozzles



1/2" SIDE FLOW NOZZLE

51836 
 (4) Side Flow Nozzles
59889    
 (20) Side Flow Nozzles







1/2" SWIVEL NOZZLE 75 FOR 1/2"

51845 
 (2) Swivel Nozzles
59895    
 (20) Swivel Nozzles
 • .075" Hole diameter







1/4" STRAIGHT FLOW NOZZLE

51847 
 (2) Straight Flow Nozzles
59897    
 (20) Straight Flow Nozzles







1/8" STRAIGHT FLOW NOZZLE

51848 
 (2) Straight Flow Nozzles
59898    
 (20) Straight Flow Nozzles







1/2" FLAT SLOT 80 NOZZLE

51840 
 (4) Flat Slot Nozzles
59890    
 (20) Flat Slot Nozzles
 • .080" Slot height



1/2" FLAT SLOT 125 NOZZLE

51841 
 (4) Flat Slot Nozzles
59891    
 (20) Flat Slot Nozzles
 • .125" Slot height







1/2" FLAT 5-HOLE NOZZLE

51842 
 (4) Flat 5-Hole Nozzles
59892    
 (20) Flat 5-Hole Nozzles
 • .125" Hole diameter







1/2" FLAT 7 HOLE NOZZLE

51843 
 (4) Flat 7-Hole Nozzles
59893    
 (20) Flat 7-Hole Nozzles
 • .080" Hole diameter







VALVES

1/2" MALE NPT VALVE

32092 
 (2) Male NPT Valves
39852    
 (10) Male NPT Valves



1/2" FEMALE NPT VALVE

32093 
 (2) Female NPT Valves
39853    
 (10) Female NPT Valves







1/2" IN-LINE VALVE

32094 
 (2) In-Line Valves
39854    
 (10) In-Line Valves



1/2" IN-LINE CHECK VALVE

32091 
 (2) Check Valves
39851    
 (10) Check Valves



1/2-INCH SYSTEM

CONNECTORS

3/8" NPT CONNECTOR

51804 

(4) NPT Connectors

59864  **-BLK**  **-G**
(50) NPT Connectors



1/2" NPT CONNECTOR

51805 

(4) NPT Connectors

59865  **-BLK**  **-G**
(50) NPT Connectors



3/8" SAE FLARE NUT ADAPTER

51823 

(4) Flare Nut Adapters

59873  **-BLK**  **-G**
(20) Flare Nut Adapters



5/8 - 18 Thread

3/8" BSPT* CONNECTOR

51826 

(4) BSPT Connectors

59876  **-BLK**  **-G**
(50) BSPT Connectors



* British Standard Pipe Thread

1/2" BSPT* CONNECTOR

51827 

(4) BSPT Connectors

59877  **-BLK**  **-G**
(50) BSPT Connectors



* British Standard Pipe Thread

1/2" FIXED MOUNT

51895 

(2) Fixed Mounts

59896  **-BLK**  **-G**
(20) Fixed Mounts



• Mounts with 1/4" bolt, not included

ACCESSORIES

1/2" ELEMENT CLAMP

51834 

(4) Element Clamps
w/ Torx® T-15 screws

59884  **-BLK**  **-G**
(20) Element Clamps
w/ Torx® T-15 screws



1/2" ELBOW FITTING

51824 

(2) Elbow Fittings

59874  **-BLK**  **-G**
(20) Elbow Fittings



1/2" T FITTING

51825 

(2) T Fittings

59875  **-BLK**  **-G**
(20) T Fittings



1/2" Y FITTING

51808 

(2) Y Fittings

59868  **-BLK**  **-G**
(20) Y Fittings



1/2" END CAP

51838 

(4) End Caps

59885  **-BLK**  **-G**
(20) End Caps



1/2" TO 1/4" Y REDUCER

51822 

(2) Y Reducers

59870  **-BLK**  **-G**
(20) Y Reducers



1/2" DOUBLE SOCKET

51811 

(4) Double Sockets

59872  **-BLK**  **-G**
(20) Double Sockets



1/2" MAGNETIC BASE

51846 

(1) Magnetic Base

• 60# holding force



1/2" TO 1/4" ADAPTER

51821 

(2) Adapters

59869  **-BLK**  **-G**
(20) Adapters



HOW TO ORDER BLACK OR GRAY LOC-LINE:

-BLK Part can be ordered in Black.

Add suffix to part number when ordering, ie: **59861-BLK**

-G Part can be ordered in Gray.

Add suffix to part number when ordering, ie: **59861-G**

MANIFOLDS

1/2" MODULAR MANIFOLD

32099

(3) 1/2" T Fittings
(1) 1/2" Elbow Fitting
(1) 1/2" Manifold
Bracket
(3) Mounting Screws



1/2" TOTAL FLOW CONTROL MANIFOLD

32098

(1) 1/2" Modular Manifold
(5) 1/2" In-Line Valves



1/2" MODULAR MANIFOLD BRACKET

32095 

(2) Brackets



ACID RESISTANT

1/2" ACID RESISTANT HOSE KIT

- 56863** 🚧
(2) 5½" Long Segments
- (1) 1/4" Round Nozzle
- (1) 3/8" Round Nozzle
- (1) 1/2" Round Nozzle
- (1) 3/8" NPT Connector
- (1) 1/2" NPT Connector



1/2" ACID RESISTANT HOSE

- 56801** 🚧
(2) 5½" Long Segments
- 57860** 🚧
(59) Segments, Bulk 25 ft.
- 57859** 🚧
(1) 5 ft Coil
- 57861** 🚧
(1) 50 ft Coil



1/4" ACID RESISTANT NOZZLE

- 56806** 🚧
(4) Round Nozzles
- 57866** 🚧
(50) Round Nozzles



3/8" ACID RESISTANT NOZZLE

- 56802** 🚧
(4) Round Nozzles
- 57862** 🚧
(50) Round Nozzles



1/2" ACID RESISTANT NOZZLE

- 56803** 🚧
(4) Round Nozzles
- 57863** 🚧
(50) Round Nozzles



3/8" ACID RESISTANT NPT

- 56804** 🚧
(4) NPT Connectors
- 57864** 🚧
(50) NPT Connectors



1/2" ACID RESISTANT NPT

- 56805** 🚧
(4) NPT Connectors
- 57865** 🚧
(50) NPT Connectors

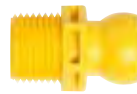

1/4" ACID RESISTANT FLARE NOZZLE

- 56807** 🚧
(2) Flare Nozzles
- 57867** 🚧
(20) Flare Nozzles



1/2" ACID RESISTANT Y FITTING

- 56808** 🚧
(2) Y Fittings
- 57868** 🚧
(20) Y Fittings



1/2" TO 1/4" ACID RESISTANT Y REDUCER

- 56822** 🚧
(2) Y Reducers
- 57870** 🚧
(20) Reducers



1/2" TO 1/4" ACID RESISTANT ADAPTER

- 56821** 🚧
(2) Adapters
- 57869** 🚧
(20) Adapters



1/2" ACID RESISTANT ELBOW FITTING

- 56824** 🚧
(2) Elbow Fittings
- 57874** 🚧
(20) Elbow Fittings



1/2" ACID RESISTANT T FITTING

- 56825** 🚧
(2) T Fittings
- 57875** 🚧
(20) T Fittings



- Loc-Line® Acid Resistant Hose is excellent for rinsing cycles in plating operations.
- Acid environments won't corrode the Loc-Line® Acid Resistant Hose because of its polyester composition.
- CAUTION:** Loc-Line® Acid Resistant Hose is not intended for conveying acids or high pressure applications.





3/4-INCH SYSTEM

KITS

3/4" HOSE KIT

60513

- (2) 5 3/4" Long Segments
- (1) 5/8" Round Nozzle
- (1) 3/4" Round Nozzle
- (1) 3/4" NPT Connector

• Assembled Length = 14"



PLIERS

3/4" HOSE ASSEMBLY PLIERS

78004

- (1) 3/4" Pliers



• 3/4" Assembly Pliers will not assemble the 3/4" Y Fitting, the 3/4" Fixed Mount or the 3/4" Valves.

HOSES

3/4" HOSE

61501

- (2) 5 3/4" Long Segments

69540 ■-BLK ■-G
(54) Segments, Bulk 25 ft

69539 ■-BLK ■-G

- (1) 5 ft Coil

69541 ■-BLK ■-G

- (1) 50 ft Coil

• 1 Segment = 6 Elements



NOZZLES

5/8" ROUND NOZZLE

61503

- (4) Round Nozzles

69543 ■-BLK ■-G

- (50) Round Nozzles



3/4" ROUND NOZZLE

61502

- (4) Round Nozzles

69542 ■-BLK ■-G

- (50) Round Nozzles



3" FLARE NOZZLE

61507

- (2) Flare Nozzles

69547 ■-BLK ■-G

- (20) Flare Nozzles



VALVES

3/4" MALE NPT VALVE

61516

- (2) NPT Valves

69556 ■-BLK ■-G

- (10) NPT Valves



3/4" FEMALE NPT VALVE

61517

- (2) Female NPT Valves

69557 ■-BLK

■-G

- (10) Female NPT Valves



3/4" IN-LINE VALVE

61518

- (2) In-Line Valves

69558 ■-BLK ■-G

- (10) In-Line Valves



CONNECTORS

3/4" NPT CONNECTOR

61505

- (4) NPT Connectors

69545 ■-BLK ■-G

- (50) NPT Connectors



3/4" BSPT* CONNECTOR

61509

- (4) BSPT Connectors

69549 ■-BLK ■-G

- (50) BSPT Connectors



* British Standard Pipe Thread

3/4" FIXED MOUNT

60533

- (2) Fixed Mounts

69563 ■-BLK ■-G

- (20) Fixed Mounts



• Mounts with 1/4" bolt, not included

ACCESSORIES

3/4" Y FITTING

61511

- (2) Y Fittings

69551 ■-BLK ■-G

- (20) Y Fittings



3/4" ELBOW FITTING

61515

- (2) Elbow Fittings

69555 ■-BLK ■-G

- (20) Elbow Fittings



3/4" TO 1/2" Y REDUCER

61512

- (2) Y Reducers

69552 ■-BLK ■-G

- (20) Y Reducers



3/4" TO 1/2" ADAPTER

61508

- (2) Adapters

69548 ■-BLK ■-G

- (20) Adapters



3/4" DOUBLE SOCKET

61514

- (4) Double Sockets

69554 ■-BLK ■-G

- (20) Double Sockets



HOW TO ORDER BLACK OR GRAY LOC-LINE:

■-BLK Part can be ordered in Black.

Add suffix to part number when ordering, ie: **69541-BLK**

■-G Part can be ordered in Gray.

Add suffix to part number when ordering, ie: **69541-G**

KIT

QUICK-SET SHIELD™ KIT

60525

(1) 6"x8" Shield Kit

60526

(1) 7½"x10" Shield Kit

60527

(1) 8½"x12" Shield Kit

• All Quick-Set Shield Kits include a 14" adjustable 3/4" Loc-Line® arm, magnetic base and fitting for fixed mounting.



CONNECTOR

3/4" FIXED MOUNT

60533 ■

(2) Fixed Mounts

69563 ■ ■-BLK ■-G

(20) Fixed Mounts

• Mounts with 1/4" bolt, not included.



ACCESSORIES

SHIELD MOUNTING ELBOW

60531 ■

(2) Mounting Elbows

69561 ■ ■-BLK ■-G

(20) Mounting Elbows

• Washer and screw included



REPLACEMENT SHIELD

60528

(1) 6" x 8" Shield

60529

(1) 7½" x 10" Shield

60530

(1) 8½" x 12" Shield



3/4" MAGNETIC BASE

60532 ■ ■-BLK ■-G

(1) Magnetic Base

• 60 lb. holding force



2 1/2-INCH SYSTEM



NOZZLES

4 1/2" ROUND NOZZLE

- 81203** 🚧
(1) Round Nozzle
- 89223** 🚧
(10) Round Nozzles



TAPERED OVAL NOZZLE

- 81205** 🚧
(1) Oval Nozzle
- 89225** 🚧
(10) Oval Nozzles



6" x 3 1/2" RECTANGULAR NOZZLE

- 81204** 🚧
(1) Rectangular Nozzle
- 89224** 🚧
(10) Rectangular Nozzles



VALVES

2 1/2" SLIDE VALVE

- 81208** 🚧
(1) Slide Valve
- 89228** 🚧
(10) Slide Valves



HOSES

2 1/2" HOSE

- 81201** 🚧
(1) 12" Segment*
- 81202** 🚧
(2) 12" Segments
- 89220** 🚧
(20) 12" Segments



- *1 Segment = 9 Elements
- Hose Bending Radius = 5.75"

CONNECTORS

3" PVC ADAPTER

- 81206** 🚧
(1) PVC Adapter
- 89226** 🚧
(10) PVC Adapters



3" SHEET METAL DUCT ADAPTER

- 81207** 🚧
(1) Sheet Metal Duct Adapter
- 89227** 🚧
(10) Sheet Metal Duct Adapters



ACCESSORIES

SHOP VACUUM HOSE ADAPTER WITH MOUNTING TAB

- 81209** 🚧
(1) Shop Vacuum Adapter
- 89229** 🚧
(10) Shop Vacuum Adapters



SHOP VACUUM ADAPTER

- 81210** 🚧
(1) Shop Vacuum Adapter
- 89230** 🚧
(10) Shop Vacuum Adapters



ANTI-STATIC

2 1/2" HOSE

- 81301AS** 🚧
(1) 12" Anti-Static Segment*
- 81302AS** 🚧
(2) 12" Anti-Static Segments
- 89320AS** 🚧
(20) 12" Anti-Static Segments



- *1 Segment = 9 Elements

4 1/2" ROUND NOZZLE

- 81303AS** 🚧
(1) Anti-Static Round Nozzle
- 89323AS** 🚧
(10) Anti-Static Round Nozzles



6" x 3 1/2" RECTANGULAR NOZZLE

- 81304AS** 🚧
(1) Anti-Static Rectangular Nozzle
- 89324AS** 🚧
(10) Anti-Static Rectangular Nozzles



TAPERED OVAL NOZZLE

- 81305AS** 🚧
(1) Anti-Static Oval Nozzle
- 89325AS** 🚧
(10) Anti-Static Oval Nozzles



2 1/2" SLIDE VALVE

- 81308AS** 🚧
(1) Anti-Static Slide Valve
- 89328AS** 🚧
(10) Anti-Static Slide Valves



3" SHEET METAL DUCT ADAPTER

- 81307AS** 🚧
(1) Anti-Static Metal Duct Adapter
- 89327AS** 🚧
(10) Anti-Static Metal Duct Adapters



TECH SPECS

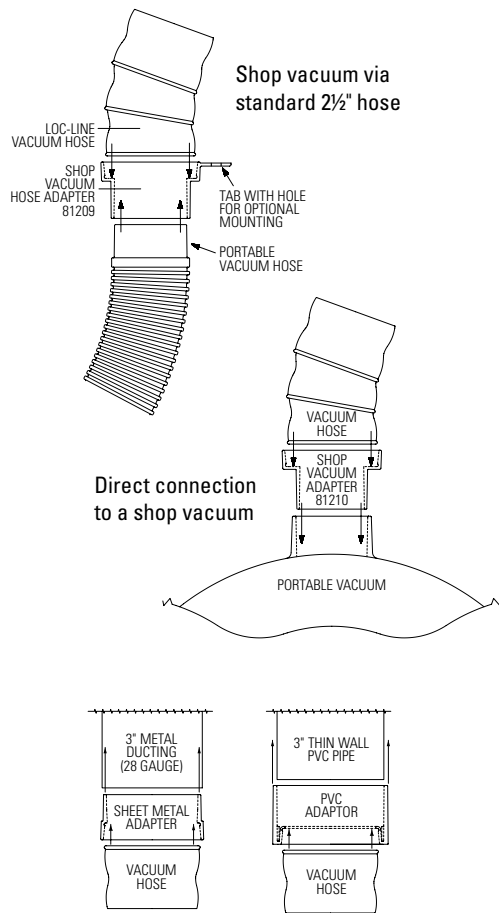



Hose connects to 3" metal duct or PVC pipe using Loc-Line adapters





TEFEN™ FITTINGS

Tefen™ products change male fittings to female threads. Tefen products are made in Israel.

1/8" FEMALE PIPE COUPLING

- 40656**  (4) Female Pipe Couplings
- 41756**  (20) Female Pipe Couplings

1/4" FEMALE PIPE COUPLING

- 40657**  (4) Female Pipe Couplings
- 41757**  (20) Female Pipe Couplings



3/8" FEMALE PIPE COUPLING

- 50660**  (4) Female Pipe Couplings
- 51760**  (20) Female Pipe Couplings



1/2" FEMALE PIPE COUPLING

- 50661**  (4) Female Pipe Couplings
- 51761**  (20) Female Pipe Couplings



1/4" TO 1/8" FEMALE PIPE REDUCER

- 40655**  (4) Female Pipe Reducers
- 41755**  (20) Female Pipe Reducers

3/8" TO 1/4" FEMALE PIPE REDUCER

- 50658**  (4) Female Pipe Reducers
- 51758**  (20) Female Pipe Reducers

1/2" TO 1/4" FEMALE PIPE REDUCER

- 50659**  (4) Female Pipe Reducers
- 51759**  (20) Female Pipe Reducers

A WORLD OF POSSIBILITIES

VACUUM



MACHINE TOOL

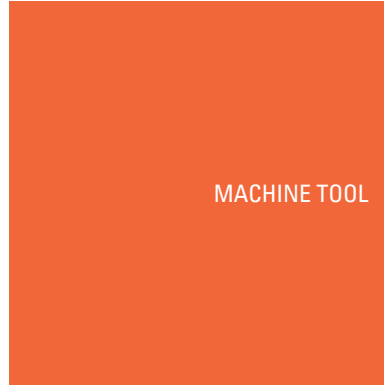

PARTS WASHER
BY CHEMFREE



FLAREDINKUM PRO



PAINTLESS AUTO BODY
DENT REPAIR



ASSISTIVE
TECHNOLOGY



MACHINE TOOL

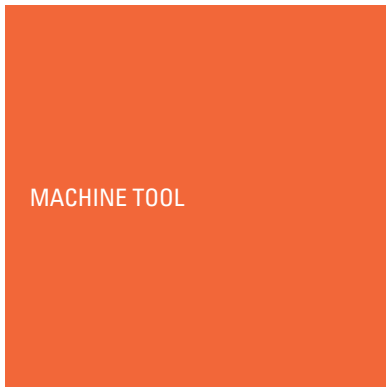

SNAKE LIGHT™
BY BLACK AND DECKER

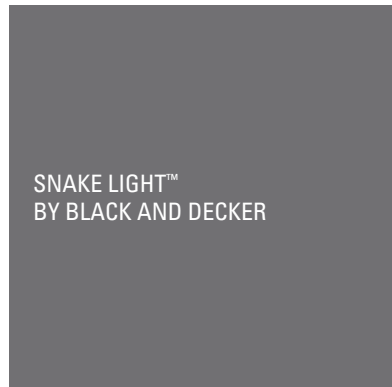

AQUARIUM



ACTION POD
BY DINKUM



MIST DISPENSING
BY TRICO



COLD GUN
BY EXAIR



CHERRY CREEK SYSTEMS
GREENHOUSE PRODUCTS



MACHINE TOOL

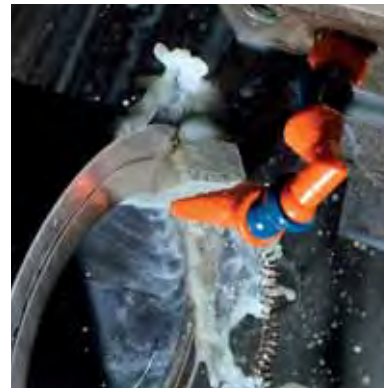

VACUUM ARM BY
AMERICAN HAKKO



AIR DELIVERY



TECHNICAL INFORMATION

IDENTIFYING LOC-LINE SYSTEMS

1/4" SYSTEM



1/2" SYSTEM



3/4" SYSTEM



2-1/2" SYSTEM



MEASURING LOC-LINE

1/4" SYSTEM

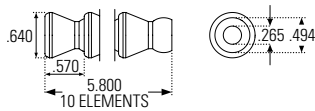

1/2" SYSTEM

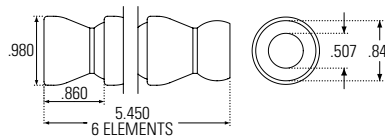

3/4" SYSTEM

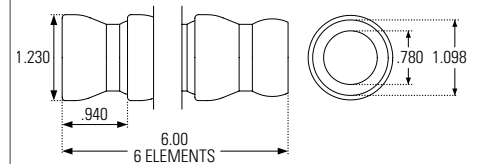

MINIMUM HOSE BENDING DIAMETER

1/4" SYSTEM

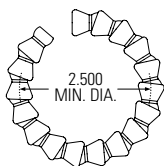

1/2" SYSTEM

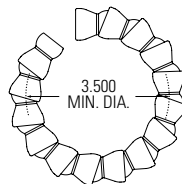

3/4" SYSTEM

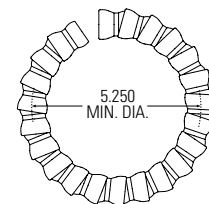

LOC-LINE VALVE SPECIFICATIONS

1/4" VALVES

- Full 1/4" inside diameter
- Maximum Working Pressures:
 - 1/4" Hose: 30 PSI
 - 1/4" In-Line Valve: 30 PSI
 - 1/4" Male and Female NPT Valves: 100 PSI (1/4" Hose limits most applications to 30 PSI)
- Body and stem material: Acetal Copolymer
- Stem seal: Nitrile (Buna N)
- 1/4-turn shut off

1/2" VALVES

- Full 1/2" inside diameter
- Maximum Working Pressures:
 - 1/2" Hose: 20 PSI
 - 1/2" In-Line Valve: 20 PSI
 - 1/2" Male and Female NPT Valves: 100 PSI (1/2" Hose limits most applications to 20 PSI)
- Body and stem material: Acetal Copolymer
- Stem seal: Nitrile (Buna N)
- 1/4-turn shut off

3/4" VALVES

- Full 3/4" inside diameter
- Maximum Working Pressures:
 - 3/4" Hose: 10 PSI
 - 3/4" In-Line Valve: 10 PSI
 - 3/4" Male and Female NPT Valves: 50 PSI (3/4" Hose limits most applications to 10 PSI)
- Body and stem material: Acetal Copolymer
- Stem seal: Nitrile (Buna N)
- 1/4-turn shut off

LINE PRESSURE AND FLOW RATES

1/4" SYSTEM

	LINE PRESSURE	FLOW RATE
Standard	30 – 50 PSI	250 gal/hr
w/ clamps	up to 110 PSI*	

*Assumes use of element clamps on all joints and fully tightened.

Please note that all applications have variables and conditions that will affect the maximum hose pressures. Testing is always recommended whenever possible.

1/2" SYSTEM

	LINE PRESSURE	FLOW RATE
Standard	20 – 30 PSI	478 gal/hr
w/ clamps	up to 110 PSI*	

*Assumes use of element clamps on all joints and fully tightened.

3/4" SYSTEM

	LINE PRESSURE	FLOW RATE
Standard	10 – 20 PSI	1,140 gal/hr

Additional flow rate information and graphs can be viewed at www.loc-line.com

ASSEMBLY PROCEDURES AND TIPS

Loc-Line Assembly Pliers are strongly recommended for assembling Loc-Line. Available for 1/4", 1/2" and 3/4" Systems. *Please note there are a few exceptions where 3/4" Pliers do not work including: 3/4" Valves, 3/4" Y's and 3/4" Fixed Mounts.*

Rod Assembly Method: Place the various pieces you would like assembled together over an appropriately sized dowel rod that is clamped into a vise or other stable base. Push the pieces together until they snap.

If you're having difficulty with an **NPT Connector**, rub the ball with your fingers. The oil on your hands will make it easier to assemble.

If you are **assembling a large number of parts**, the use of 409® All-Purpose Cleaner will act as a lubricant to make assembly easier.

MATERIAL SPECIFICATIONS

COMMON COMPATIBILITY WITH LOC-LINE ACETAL PRODUCTS

■ BLUE ■ ORANGE ■ BLACK ■ GREY

Yes	Acetone
No	Acids
Yes	Alcohol, Ethyl
No	Ammonium Hydroxide, Strong
No	Bases, Strong
Yes	Commercial Dish Detergents
Yes	Gasoline
Yes	Greases
No	Hypochlorite Ion Solutions
Yes	Lacquer Solvents
Yes	Oils
Yes	Sodium Hydroxide
No	Sodium Hypochlorite

ACETAL TEMPERATURE DATA

■ BLUE ■ ORANGE ■ BLACK ■ GREY

Melting point: 329° F
Maximum operating temperature: 170° F

ACETAL ANTI-STATIC ELECTRICAL PROPERTIES

■ BLACK (2½" System)

Surface Resistivity: 1.000E3 Ohm
Volume Resistivity: <6.000E2 Ohm-cm

COMMON COMPATIBILITY WITH LOC-LINE POLYESTER PRODUCTS

■ YELLOW ACID RESISTANT

No	Acetone
Yes	Acids, (Less than 150° F)
No	Acids, (Greater than 150° F)
Yes	Alcohols
Yes	Aromatic Solvents
No	Chlorinated Hydrocarbon
No	Bases, Strong
No	Ethyl Acetate
Yes	Gasoline
Yes	Greases
Yes	Hydrocarbons
Yes	Oils
Yes	Salt Solutions

TEMPERATURE DATA - POLYESTER

■ YELLOW ACID RESISTANT

Melting point: 475° F
Maximum operating temperature: 170° F

REGULATORY INFORMATION

FDA – Acetal Copolymer meets the requirements for food contact in accordance to the rules in 21CFR 177.2470. All color pigments are used at the recommended let-down ratio that meet 21CFR 178.3297.

NSF – Acetal Copolymer meets the Standards 14, 51 and 61 meet plumbing items in contact with potable water.

Loc-Line products are REACH compliant and RoHS compliant. Loc-Line products are free from Ozone depleting chemicals.

Lockwood Products, Inc. does not produce Loc-Line in a FDA certified facility. Nor does Lockwood Products, Inc. warrant any particular application.



PART NUMBER INDEX

■ Part is Blue
 ■ Part is Orange
 ■ Part is Black
 ■ Part is Gray
 ■ Part is Yellow

PART NO.	ITEM DESCRIPTION	PG	PART NO.	ITEM DESCRIPTION	PG	PART NO.	ITEM DESCRIPTION	PG
21191	1/4" In-Line Check Valve (2pcs) ■	7	41495	HAAS X 2" Lathe Adapter (4pcs) ■	8	49440	1/8" 90° Nozzle (20pcs) ■	7
21192	1/4" Male NPT Valve (2pcs) ■	7	41755	1/4" to 1/8" Female Pipe Reducer (20pcs) ■	17	49440-BLK	1/8" 90° Nozzle (20pcs) ■	7
21193	1/4" Female NPT Valve (2pcs) ■	7	41756	1/8" Female Pipe Coupling (20pcs) ■	17	49440-G	1/8" 90° Nozzle (20pcs) ■	7
21194	1/4" In-Line Valve (2pcs) ■	7	41757	1/4" Female Pipe Coupling (20pcs) ■	17	49441	1/4" 90° Nozzle, 1/4" System (20pcs) ■	7
21195	1/4" Manifold Bracket (2pcs) ■	9	45401	1/4" AR Hose Segment (2pcs) ■	9	49441-BLK	1/4" 90° Nozzle, 1/4" System (20pcs) ■	7
21198	1/4" Total Flow Control Manifold	9	45402	1/16" AR Round Nozzle (4pcs) ■	9	49441-G	1/4" 90° Nozzle, 1/4" System (20pcs) ■	7
21199	1/4" Modular Manifold	9	45403	1/8" AR Round Nozzle (4pcs) ■	9	49442	1/4" 90° Spray Bar Nozzle (20pcs) ■	7
29451	1/4" In-Line Check Valve (10pcs) ■	7	45404	1/4" AR Round Nozzle (4pcs) ■	9	49442-BLK	1/4" 90° Spray Bar Nozzle (20pcs) ■	7
29451-BLK	1/4" In-Line Check Valve (10pcs) ■	7	45405	1/8" AR NPT Connector (4pcs) ■	9	49442-G	1/4" 90° Spray Bar Nozzle (20pcs) ■	7
29451-G	1/4" In-Line Check Valve (10pcs) ■	7	45406	1/4" AR NPT Connector (4pcs) ■	9	49443	1/4" Side Flow Nozzle (20pcs) ■	7
29452	1/4" Male NPT Valve (10pcs) ■	7	45407	1" AR Flare Nozzle (2pcs) ■	9	49443-BLK	1/4" Side Flow Nozzle (20pcs) ■	7
29452-BLK	1/4" Male NPT Valve (10pcs) ■	7	45408	1/4" AR Y Fitting (2pcs) ■	9	49443-G	1/4" Side Flow Nozzle (20pcs) ■	7
29452-G	1/4" Male NPT Valve (10pcs) ■	7	45409	1/4" AR Double Socket (4pcs) ■	9	49445	1/4" Extended Element (20pcs) ■	6
29453	1/4" Female NPT Valve (10pcs) ■	7	45411	1/4" AR Socket to 1/8" FNPT (4pcs) ■	9	49445-BLK	1/4" Extended Element (20pcs) ■	6
29453-BLK	1/4" Female NPT Valve (10pcs) ■	7	45415	1/4" AR Elbow (2pcs) ■	9	49445-G	1/4" Extended Element (20pcs) ■	6
29453-G	1/4" Female NPT Valve (10pcs) ■	7	45416	1/4" AR T Fitting (2pcs) ■	9	49446	1/4" Element Clamp (20pcs) ■	8
29454	1/4" In-Line Valve (10pcs) ■	7	45463	1/4" AR Hose Assembly Kit	9	49446-BLK	1/4" Element Clamp (20pcs) ■	8
29454-BLK	1/4" In-Line Valve (10pcs) ■	7	45481	1/4" AR Socket to 1/8" FNPT (2pcs) ■	9	49446-G	1/4" Element Clamp (20pcs) ■	8
29454-G	1/4" In-Line Valve (10pcs) ■	7	45482	1/4" AR Swivel Nozzle 60 (2pcs) ■	9	49447	1/4" End Cap (20pcs) ■	8
32091	1/2" In-Line Check Valve (2pcs) ■	11	46191	1/4" AR 5 Foot Coil	9	49447-BLK	1/4" End Cap (20pcs) ■	8
32092	1/2" Male NPT Valve (2pcs) ■	11	46420	1/4" AR Hose Segments (55pc) Bulk 25 ft ■	9	49447-G	1/4" End Cap (20pcs) ■	8
32093	1/2" Female NPT Valve (2pcs) ■	11	46421	1/4" AR 50 foot Coil	9	49448	1/4" 4 Way Cross (20pcs) ■	7
32094	1/2" In-Line Valve (2pcs) ■	11	46422	1/16" AR Round Nozzle (50pcs) ■	9	49449	1/4" Swivel Nozzle 40 (20pcs) ■	7
32095	1/2" Manifold Bracket (2pcs) ■	12	46423	1/8" AR Round Nozzle (50pcs) ■	9	49449-BLK	1/4" Swivel Nozzle 40 (20pcs) ■	7
32098	1/2" Total Flow Control Manifold	12	46424	1/4" AR Round Nozzle (50pcs) ■	9	49449-G	1/4" Swivel Nozzle 40 (20pcs) ■	7
32099	1/2" Modular Manifold	12	46425	1/8" AR NPT Connector (50pcs) ■	9	49450	1/4" Swivel Nozzle 60 (20pcs) ■	7
39851	1/2" In-Line Check Valve (10pcs) ■	11	46426	1/4" AR NPT Connector (50pcs) ■	9	49450-BLK	1/4" Swivel Nozzle 60 (20pcs) ■	7
39851-BLK	1/2" In-Line Check Valve (10pcs) ■	11	46427	1" AR Flare Nozzle (20pcs) ■	9	49450-G	1/4" Swivel Nozzle 60 (20pcs) ■	7
39851-G	1/2" In-Line Check Valve (10pcs) ■	11	46428	1/4" AR Y Fitting (20pcs) ■	9	49451	1/4" Flat Slot 40 Nozzle (20pcs) ■	7
39852	1/2" Male NPT Valve (10pcs) ■	11	46429	1/4" AR Double Socket (20pcs) ■	9	49451-BLK	1/4" Flat Slot 40 Nozzle (20pcs) ■	7
39852-BLK	1/2" Male NPT Valve (10pcs) ■	11	46431	1/4" AR Socket to 1/8" FNPT (20pcs) ■	9	49451-G	1/4" Flat Slot 40 Nozzle (20pcs) ■	7
39852-G	1/2" Male NPT Valve (10pcs) ■	11	46435	1/4" AR Elbow (20pcs) ■	9	49452	1/4" Flat Slot 60 Nozzle (20pcs) ■	7
39853	1/2" Female NPT Valve (10pcs) ■	11	46436	1/4" AR T Fitting (20pcs) ■	9	49452-BLK	1/4" Flat Slot 60 Nozzle (20pcs) ■	7
39853-BLK	1/2" Female NPT Valve (10pcs) ■	11	46449	1/4" AR Swivel Nozzle 40 (20pcs) ■	9	49452-G	1/4" Flat Slot 60 Nozzle (20pcs) ■	7
39853-G	1/2" Female NPT Valve (10pcs) ■	11	46450	1/4" AR Swivel Nozzle 60 (20pcs) ■	9	49453	1/4" Flat 5 Hole Nozzle (20pcs) ■	7
39854	1/2" In-Line Valve (10pcs) ■	11	49419	1/4" 5 Foot Coil	6	49453-BLK	1/4" Flat 5 Hole Nozzle (20pcs) ■	7
39854-BLK	1/2" In-Line Valve (10pcs) ■	11	49419-BLK	1/4" 5 Foot Coil ■	6	49453-G	1/4" Flat 5 Hole Nozzle (20pcs) ■	7
39854-G	1/2" In-Line Valve (10pcs) ■	11	49419-G	1/4" 5 Foot Coil ■	6	49454	1/4" Flat 7 Hole Nozzle (20pcs) ■	7
40400	Magnetic Base Manifold	9	49420	1/4" Hose Segments (55pc) Bulk 25 ft ■	6	49454-BLK	1/4" Flat 7 Hole Nozzle (20pcs) ■	7
40413	1/4" Hose Assembly Kit	6	49420-BLK	1/4" Hose Segments (55pc) Bulk 25 ft ■	6	49454-G	1/4" Flat 7 Hole Nozzle (20pcs) ■	7
40452	1/4" Flared Tubing Replacement Pack	6	49420-G	1/4" Hose Segments (55pc) Bulk 25 ft ■	6	49455	2 1/2" Swivel Nozzle 75 (20pcs) ■	7
40463	Magnetic Base Manifold Kit	9	49421	1/4" 50 Foot Coil ■	6	49455-BLK	2 1/2" Swivel Nozzle 75 (20pcs) ■	7
40472	1/4" Extended Elbow Kit	6	49421-BLK	1/4" 50 Foot Coil ■	6	49455-G	2 1/2" Swivel Nozzle 75 (20pcs) ■	7
40473	1/4" Mixed Element Kit	6	49421-G	1/4" 50 Foot Coil ■	6	49456	1" Straight Flow Nozzle (20pcs) ■	7
40474	1/4" Extended Elbows with Clamps	6	49422	1/16" Round Nozzle (50pcs) ■	7	49456-BLK	1" Straight Flow Nozzle (20pcs) ■	7
40475	HAAS Lathe Adaptor Kit	6	49422-BLK	1/16" Round Nozzle (50pcs) ■	7	49456-G	1" Straight Flow Nozzle (20pcs) ■	7
40476	15MM Lathe Adaptor Kit	6	49422-G	1/16" Round Nozzle (50pcs) ■	7	49457	1/4" Extended Elbows (20pcs) ■	6
40480	Magnetic Base Manifold Super Kit	9	49423	1/8" Round Nozzle (50pcs) ■	7	49457-BLK	1/4" Extended Elbows (20pcs) ■	6
40655	1/4" to 1/8" Female Pipe Reducer (4pcs) ■	17	49423-BLK	1/8" Round Nozzle (50pcs) ■	7	49457-G	1/4" Extended Elbows (20pcs) ■	6
40656	1/8" Female Pipe Coupling (4pcs) ■	17	49423-G	1/8" Round Nozzle (50pcs) ■	7	49458	15MM X Short Lathe Adapter (20pcs) ■	8
40657	1/4" Female Pipe Coupling (4pcs) ■	17	49424	1/4" Round Nozzle, 1/4" System (50pcs) ■	7	49458-BLK	15MM X Short Lathe Adapter (20pcs) ■	8
41401	1/4" Hose Segment (2pcs) ■	6	49424-BLK	1/4" Round Nozzle, 1/4" System (50pcs) ■	7	49458-G	15MM X Short Lathe Adapter (20pcs) ■	8
41402	1/16" Round Nozzle (4pcs) ■	7	49424-G	1/4" Round Nozzle, 1/4" System (50pcs) ■	7	49459	15MM X 2" Lathe Adapter (20pcs) ■	8
41403	1/8" Round Nozzle (4pcs) ■	7	49425	1/8" NPT Connector (50pcs) ■	8	49459-BLK	15MM X 2" Lathe Adapter (20pcs) ■	8
41404	1/4" Round Nozzle (4pcs) ■	7	49425-BLK	1/8" NPT Connector (50pcs) ■	8	49459-G	15MM X 2" Lathe Adapter (20pcs) ■	8
41405	1/8" NPT Connector (4pcs) ■	8	49425-G	1/8" NPT Connector (50pcs) ■	8	49460	HAAS X Short Lathe Adapter (20pcs) ■	8
41406	1/4" NPT Connector (4pcs) ■	8	49426	1/4" NPT Connector (50pcs) ■	8	49460-BLK	HAAS X Short Lathe Adapter (20pcs) ■	8
41407	1" Flare Nozzle (2pcs) ■	7	49426-BLK	1/4" NPT Connector (50pcs) ■	8	49460-G	HAAS X Short Lathe Adapter (20pcs) ■	8
41408	1/4" Y Fitting (2pcs) ■	8	49426-G	1/4" NPT Connector (50pcs) ■	8	49461	HAAS X 2" Lathe Adapter (20pcs) ■	8
41409	1/4" Double Socket (4pcs) ■	8	49427	1" Flare Nozzle (20pcs) ■	7	49461-BLK	HAAS X 2" Lathe Adapter (20pcs) ■	8
41411	1/4" Socket to 1/8" FNPT (4pcs) ■	8	49427-BLK	1" Flare Nozzle (20pcs) ■	7	49461-G	HAAS X 2" Lathe Adapter (20pcs) ■	8
41412	3/8" Flare Nut Adapter, 1/4" System (4pcs) ■	8	49427-G	1" Flare Nozzle (20pcs) ■	7	50658	3/8" to 1/4" FNPT Reducer (4pcs) ■	17
41414	1/4" Flare Nut Adapter (4pcs) ■	8	49428	1/4" Y Fitting (20pcs) ■	8	50659	1/2" to 1/4" FNPT Reducer (4pcs) ■	17
41415	1/4" Elbow (2pcs) ■	8	49428-BLK	1/4" Y Fitting (20pcs) ■	8	50660	3/8" Female Coupling (4pcs) ■	17
41416	1/4" T Fitting (2pcs) ■	8	49428-G	1/4" Y Fitting (20pcs) ■	8	50661	1/2" Female Coupling (4pcs) ■	17
41417	1/8" BSPT Fitting (4pcs) ■	8	49429	1/4" Double Socket (20pcs) ■	8	50813	1/2" Hose Assembly Kit	10
41418	1/4" BSPT Fitting (4pcs) ■	8	49429-BLK	1/4" Double Socket (20pcs) ■	8	50872	1/2" Extended Elbow Kit	10
41470	1/16" 90° Nozzle (4pcs) ■	7	49429-G	1/4" Double Socket (20pcs) ■	8	50873	1/2" Mixed Element Kit	10
41471	1/8" 90° Nozzle (4pcs) ■	7	49431	1/4" Socket to 1/8" FNPT (20pcs) ■	8	50874	1/2" Extended Elbows with Clamps	10
41472	1/4" 90° Nozzle, 1/4" System (4pcs) ■	7	49431-BLK	1/4" Socket to 1/8" FNPT (20pcs) ■	8	51758	3/8" to 1/4" FNPT Reducer (20pcs) ■	17
41473	1/4" 90° Spray Bar Nozzle (2pcs) ■	7	49431-G	1/4" Socket to 1/8" FNPT (20pcs) ■	8	51759	1/2" to 1/4" FNPT Reducer (20pcs) ■	17
41474	1/4" 90° Nozzle Kit	7	49432	3/8" Flare Nut Adapter, 1/4" Sys (20pcs) ■	8	51760	3/8" Female Coupling (20pcs) ■	17
41475	1/4" Extended Element Kit	6	49432-BLK	3/8" Flare Nut Adapter, 1/4" Sys (20pcs) ■	8	51761	1/2" Female Coupling (20pcs) ■	17
41476	1/4" Extended Element (4pcs) ■	6	49432-G	3/8" Flare Nut Adapter, 1/4" Sys (20pcs) ■	8	51801	1/2" Hose Segment Pack (2pcs) ■	10
41477	1/4" Element Clamp (4pcs) ■	8	49434	1/4" SAE Flare Nut Adapter (20pcs) ■	8	51802	3/8" Round Nozzle (4pcs) ■	11
41478	1/4" Side Flow Nozzle (4pcs) ■	7	49434-BLK	1/4" SAE Flare Nut Adapter (20pcs) ■	8	51803	1/2" Round Nozzle (4pcs) ■	11
41479	1/4" Circle Flow Nozzle Kit 1pc	6	49434-G	1/4" SAE Flare Nut Adapter (20pcs) ■	8	51804	3/8" NPT Connector (4pcs) ■	12
41480	1/4" End Cap (4pcs) ■	8	49435	1/4" Elbow (20pcs) ■	8	51805	1/2" NPT Connector (4pcs) ■	12
41481	1/4" Swivel Nozzle 40 (2pcs) ■	7	49435-BLK	1/4" Elbow (20pcs) ■	8	51806	1/4" Round Nozzle, 1/2" System (4pcs) ■	11
41482	1/4" Swivel Nozzle 60 (2pcs) ■	7	49435-G	1/4" Elbow (20pcs) ■	8	51807	1 1/4" Flare Nozzle (2pcs) ■	11
41483	1/4" Flat Slot 40 Nozzle (4pcs) ■	7	49436	1/4" T Fitting (20pcs) ■	8	51808	1/2" Y Fitting (2pcs)	

PART NO.	ITEM DESCRIPTION	PG	PART NO.	ITEM DESCRIPTION	PG	PART NO.	ITEM DESCRIPTION	PG
51830	1/2" 90° Nozzle (4pcs) ■	11	59873	3/8" SAE Flare Nut, 1/2" System (20pcs) ■	12	61518	3/4" In-line Valve (2pcs) ■	14
51831	1/2" 90 Spray Bar Nozzle (2pcs) ■	11	59873-BLK	3/8" SAE Flare Nut, 1/2" System (20pcs) ■	12	69539	3/4" - 5 Foot Coil ■	14
51832	1/2" 90° Nozzle Kit ■	11	59873-G	3/8" SAE Flare Nut, 1/2" System (20pcs) ■	12	69539-BLK	3/4" - 5 Foot Coil ■	14
51833	1/2" Extended Element (4pcs) ■	10	59874	1/2" Elbow (20pcs) ■	12	69539-G	3/4" - 5 Foot Coil ■	14
51834	1/2" Element Clamp (4pcs) ■	12	59874-BLK	1/2" Elbow (20pcs) ■	12	69540	3/4" Hose Segment (54pc) Bulk 25 ft ■	14
51835	1/2" Extended Element Kit ■	10	59874-G	1/2" Elbow (20pcs) ■	12	69540-BLK	3/4" Hose Segment (54pc) Bulk 25 ft ■	14
51836	1/2" Side Flow Nozzle (4pcs) ■	11	59875	1/2" T Fitting (20pcs) ■	12	69540-G	3/4" Hose Segment (54pc) Bulk 25 ft ■	14
51837	1/2" Circle Flow Nozzle Kit 1pc ■	10	59875-BLK	1/2" T Fitting (20pcs) ■	12	69541	3/4" 50 Foot Coil ■	14
51838	1/2" End Cap (4pcs) ■	12	59875-G	1/2" T Fitting (20pcs) ■	12	69541-BLK	3/4" 50 Foot Coil ■	14
51840	1/2" Flat Slot 80 Nozzle (4pcs) ■	11	59876	3/8" BSPT Connector (50pcs) ■	12	69541-G	3/4" 50 Foot Coil ■	14
51841	1/2" Flat Slot 125 Nozzle (4pcs) ■	11	59876-BLK	3/8" BSPT Connector (50pcs) ■	12	69542	3/4" Round Nozzle (50pcs) ■	14
51842	1/2" Flat 5 Hole Nozzle (4pcs) ■	11	59876-G	3/8" BSPT Connector (50pcs) ■	12	69542-BLK	3/4" Round Nozzle (50pcs) ■	14
51843	1/2" Flat 7 Hole Nozzle (4pcs) ■	11	59877	1/2" BSPT Connector (50pcs) ■	12	69542-G	3/4" Round Nozzle (50pcs) ■	14
51844	1/2" Flat Nozzle Assortment Pack ■	11	59877-BLK	1/2" BSPT Connector (50pcs) ■	12	69543	5/8" Round Nozzle (50pcs) ■	14
51845	2 1/2" Swivel Nozzle 75, 1/2" System (2pcs) ■	11	59877-G	1/2" BSPT Connector (50pcs) ■	12	69543-BLK	5/8" Round Nozzle (50pcs) ■	14
51846	1/2" Magnetic Base ■	12	59878	1/4" 90 Nozzle, 1/2" System (20pcs) ■	11	69543-G	5/8" Round Nozzle (50pcs) ■	14
51846-BLK	1/2" Magnetic Base ■	12	59878-BLK	1/4" 90 Nozzle, 1/2" System (20pcs) ■	11	69545	3/4" NPT Connector (50pcs) ■	14
51846-G	1/2" Magnetic Base ■	12	59878-G	1/4" 90 Nozzle, 1/2" System (20pcs) ■	11	69545-BLK	3/4" NPT Connector (50pcs) ■	14
51847	1 1/4" Straight Flow Nozzle (2pcs) ■	11	59879	3/8" 90 Nozzle (20pcs) ■	11	69545-G	3/4" NPT Connector (50pcs) ■	14
51848	1 1/2" Straight Flow Nozzle (2pcs) ■	11	59879-BLK	3/8" 90 Nozzle (20pcs) ■	11	69547	3" Flare Nozzle (20pcs) ■	14
51849	1/2" Nozzle-Rama Pack (16 Nozzles) ■	11	59879-G	3/8" 90 Nozzle (20pcs) ■	11	69547-BLK	3" Flare Nozzle (20pcs) ■	14
51895	1/2" Fixed Mount (2pcs) ■	12	59880	1/2" 90 Nozzle (20pcs) ■	11	69547-G	3" Flare Nozzle (20pcs) ■	14
51896	1/2" Extended Elbow (4pcs) ■	10	59880-BLK	1/2" 90 Nozzle (20pcs) ■	11	69548	3/4" to 1/2" Adapter (20pcs) ■	14
56801	1/2" AR Hose Segment Pack (2pcs) ■	13	59880-G	1/2" 90 Nozzle (20pcs) ■	11	69548-BLK	3/4" to 1/2" Adapter (20pcs) ■	14
56802	3/8" AR Round Nozzle (4pcs) ■	13	59881	1/2" 90 Spray Bar Nozzle (20pcs) ■	11	69548-G	3/4" to 1/2" Adapter (20pcs) ■	14
56803	1/2" AR Round Nozzle (4pcs) ■	13	59881-BLK	1/2" 90 Spray Bar Nozzle (20pcs) ■	11	69549	3/4" BSPT Connector (50pcs) ■	14
56804	3/8" AR NPT Connector (4pcs) ■	13	59881-G	1/2" 90 Spray Bar Nozzle (20pcs) ■	11	69549-BLK	3/4" BSPT Connector (50pcs) ■	14
56805	1/2" AR NPT Connector (4pcs) ■	13	59883	1/2" Extended Element (20pcs) ■	10	69549-G	3/4" BSPT Connector (50pcs) ■	14
56806	1/4" AR Round Nozzle, 1/2" System (4pcs) ■	13	59883-BLK	1/2" Extended Element (20pcs) ■	10	69551	3/4" Y Fitting (20pcs) ■	14
56807	1 1/4" AR Flare Nozzle (2pcs) ■	13	59883-G	1/2" Extended Element (20pcs) ■	10	69551-BLK	3/4" Y Fitting (20pcs) ■	14
56808	1/2" AR Y Fitting (2pcs) ■	13	59884	1/2" Element Clamp (20pcs) ■	12	69551-G	3/4" Y Fitting (20pcs) ■	14
56821	1/2" to 1/4" AR Adapter (2pcs) ■	13	59884-BLK	1/2" Element Clamp (20pcs) ■	12	69552	3/4" to 1/2" Y Reducer (20pcs) ■	14
56822	1/2" to 1/4" AR Y Reducer (2pcs) ■	13	59884-G	1/2" Element Clamp (20pcs) ■	12	69552-BLK	3/4" to 1/2" Y Reducer (20pcs) ■	14
56824	1/2" AR Elbow (2pcs) ■	13	59885	1/2" End Cap (20pcs) ■	12	69552-G	3/4" to 1/2" Y Reducer (20pcs) ■	14
56825	1/2" AR T Fitting (2pcs) ■	13	59885-BLK	1/2" End Cap (20pcs) ■	12	69554	3/4" Double Socket (20pcs) ■	14
56863	1/2" AR Hose Assembly Kit ■	13	59885-G	1/2" End Cap (20pcs) ■	12	69554-BLK	3/4" Double Socket (20pcs) ■	14
57859	1/2" AR 5 Foot Coil ■	13	59887	1/2" 4 Way Cross (20pcs) ■	11	69554-G	3/4" Double Socket (20pcs) ■	14
57860	1/2" AR Hose Segment (59pc) Bulk 25 ft ■	13	59889	1/2" Side Flow Nozzle (20pcs) ■	11	69555	3/4" Elbow (20pcs) ■	14
57861	1/2" AR 50 Foot Coil ■	13	59889-BLK	1/2" Side Flow Nozzle (20pcs) ■	11	69555-BLK	3/4" Elbow (20pcs) ■	14
57862	3/8" AR Round Nozzle (50pcs) ■	13	59889-G	1/2" Side Flow Nozzle (20pcs) ■	11	69555-G	3/4" Elbow (20pcs) ■	14
57863	1/2" AR Round Nozzle (50pcs) ■	13	59890	1/2" Flat Slot 80 Nozzle (20pcs) ■	11	69556	3/4" Male NPT Valve (10pcs) ■	14
57864	3/8" AR NPT Connector (50pcs) ■	13	59890-BLK	1/2" Flat Slot 80 Nozzle (20pcs) ■	11	69556-BLK	3/4" Male NPT Valve (10pcs) ■	14
57865	1/2" AR NPT Connector (50pcs) ■	13	59890-G	1/2" Flat Slot 80 Nozzle (20pcs) ■	11	69556-G	3/4" Male NPT Valve (10pcs) ■	14
57866	1/4" AR Round Nozzle, 1/2" Sys. (50pcs) ■	13	59891	1/2" Flat Slot 125 Nozzle (20pcs) ■	11	69557	3/4" Female NPT Valve (10pcs) ■	14
57867	1 1/4" AR Flare Nozzle (20pcs) ■	13	59891-BLK	1/2" Flat Slot 125 Nozzle (20pcs) ■	11	69557-BLK	3/4" Female NPT Valve (10pcs) ■	14
57868	1/2" AR Y Fitting (20pcs) ■	13	59891-G	1/2" Flat Slot 125 Nozzle (20pcs) ■	11	69557-G	3/4" Female NPT Valve (10pcs) ■	14
57869	1/2" to 1/4" AR Adapter (20pcs) ■	13	59892	1/2" Flat 5 Hole Nozzle (20pcs) ■	11	69558	3/4" In-line Valve (10pcs) ■	14
57870	1/2" to 1/4" AR Y Reducer (20pcs) ■	13	59892-BLK	1/2" Flat 5 Hole Nozzle (20pcs) ■	11	69558-BLK	3/4" In-line Valve (10pcs) ■	14
57874	1/2" AR Elbow (20pcs) ■	13	59892-G	1/2" Flat 5 Hole Nozzle (20pcs) ■	11	69558-G	3/4" In-line Valve (10pcs) ■	14
57875	1/2" AR T Fitting (20pcs) ■	13	59893	1/2" Flat 7 Hole Nozzle (20pcs) ■	11	69561	3/4" Shield Mounting Elbow (20pcs) ■	15
59859	1/2" 5 Foot Coil ■	10	59893-BLK	1/2" Flat 7 Hole Nozzle (20pcs) ■	11	69561-BLK	3/4" Shield Mounting Elbow (20pcs) ■	15
59859-BLK	1/2" 5 Foot Coil ■	10	59893-G	1/2" Flat 7 Hole Nozzle (20pcs) ■	11	69561-G	3/4" Shield Mounting Elbow (20pcs) ■	15
59859-G	1/2" 5 Foot Coil ■	10	59895	2 1/2" Swivel Nozzle 75, 1/2" System (20pcs) ■	11	69563	3/4" Fixed Mount (20pcs) ■	15
59860	1/2" Hose Segment (59pc) Bulk 25 ft ■	10	59895-BLK	2 1/2" Swivel Nozzle 75, 1/2" System (20pcs) ■	11	69563-BLK	3/4" Fixed Mount (20pcs) ■	15
59860-BLK	1/2" Hose Segment (59pc) Bulk 25 ft ■	10	59895-G	2 1/2" Swivel Nozzle 75, 1/2" System (20pcs) ■	11	69563-G	3/4" Fixed Mount (20pcs) ■	15
59860-G	1/2" Hose Segment (59pc) Bulk 25 ft ■	10	59896	1/2" Fixed Mount (20pcs) ■	12	78001	1/4" Hose Assembly Pliers ■	6
59861	1/2" 50 Foot Coil ■	10	59896-BLK	1/2" Fixed Mount (20pcs) ■	12	78002	1/2" Hose Assembly Pliers ■	10
59861-BLK	1/2" 50 Foot Coil ■	10	59896-G	1/2" Fixed Mount (20pcs) ■	12	78003	1/4" and 1/2" Hose Assembly Plier Set ■	6,10
59861-G	1/2" 50 Foot Coil ■	10	59897	1 1/4" Straight Flow Nozzle (20pcs) ■	11	78004	3/4" Hose Assembly Pliers ■	14
59862	3/8" Round Nozzle (50pcs) ■	11	59897-BLK	1 1/4" Straight Flow Nozzle (20pcs) ■	11	81201	2 1/2" ID Hose, 9 Elements (1 ft Segment) ■	16
59862-BLK	3/8" Round Nozzle (50pcs) ■	11	59897-G	1 1/4" Straight Flow Nozzle (20pcs) ■	11	81202	2 1/2" ID Hose, 18 Elements (2 - one ft Segs) ■	16
59862-G	3/8" Round Nozzle (50pcs) ■	11	59898	1 1/2" Straight Flow Nozzle (20pcs) ■	11	81203	4 1/2" Round Nozzle (1pc) ■	16
59863	1/2" Round Nozzle (50pcs) ■	11	59898-BLK	1 1/2" Straight Flow Nozzle (20pcs) ■	11	81204	6" x 3 1/2" Rectangular Nozzle (1pc) ■	16
59863-BLK	1/2" Round Nozzle (50pcs) ■	11	59898-G	1 1/2" Straight Flow Nozzle (20pcs) ■	11	81205	Tapered Oval Nozzle (1pc) ■	16
59863-G	1/2" Round Nozzle (50pcs) ■	11	59899	1/2" Extended Elbow (20pcs) ■	10	81206	PVC Adapter for Vacuum (1pc) ■	16
59864	3/8" NPT Connector (50pcs) ■	12	59899-BLK	1/2" Extended Elbow (20pcs) ■	10	81207	3" Sheet Metal Duct Adapter (1pc) ■	16
59864-BLK	3/8" NPT Connector (50pcs) ■	12	59899-G	1/2" Extended Elbow (20pcs) ■	10	81208	2 1/2" Slide Valve (1pc) ■	16
59864-G	3/8" NPT Connector (50pcs) ■	12	60513	3/4" Hose Assembly Kit ■	14	81209	Shop Vacuum Hose Adapt. w/ Tab (1pc) ■	16
59865	1/2" NPT Connector (50pcs) ■	12	60525	6" X 8" Quick Set SML Shield Kit ■	15	81210	Shop Vacuum Adapter (1pc) ■	16
59865-BLK	1/2" NPT Connector (50pcs) ■	12	60526	7 1/2" X 10" Quick Set MED Shield Kit ■	15	81301AS	2 1/2" ID AS Hose, 9 Elements ■	16
59865-G	1/2" NPT Connector (50pcs) ■	12	60527	8 1/2" X 12" Quick Set LRG Shield Kit ■	15	81302AS	2 1/2" ID AS Hose, 18 Elements ■	16
59866	1/4" Round Nozzle, 1/2" System (50pcs) ■	11	60528	6" X 8" Replacement Shield SML ■	15	81303AS	4 1/2" AS Round Nozzle (1pc) ■	16
59866-BLK	1/4" Round Nozzle, 1/2" System (50pcs) ■	11	60529	7 1/2" X 10" Replacement Shield MED ■	15	81304AS	6" x 3 1/2" AS Rectangular Nozzle (1pc) ■	16
59866-G	1/4" Round Nozzle, 1/2" System (50pcs) ■	11	60530	8 1/2" X 12" Replacement Shield LRG ■	15	81305AS	AS Tapered Oval Nozzle (1pc) ■	16
59867	1 1/4" Flare Nozzle (20pcs) ■	11	60531	Shield Mounting Elbow (2pcs) ■	15	81307AS	3" AS Sheet Metal Duct Adapter (1pc) ■	16
59867-BLK	1 1/4" Flare Nozzle (20pcs) ■	11	60532	3/4" Magnetic Base (1pc) ■	15	81308AS	2 1/2" AS Slide Valve (1pc) ■	16
59867-G	1 1/4" Flare Nozzle (20pcs) ■	11	60532-BLK	3/4" Magnetic Base (1pc) ■	15	89220	2 1/2" ID Hose, 20 (1 ft Segments) ■	16
59868	1/2" Y Fitting (20pcs) ■	12	60532-G	3/4" Magnetic Base (1pc) ■	15	89223	4 1/2" Round Nozzle (10pcs) ■	16
59868-BLK	1/2" Y Fitting (20pcs) ■	12	60533	3/4" Fixed Mount (2pcs) ■	15	89224	6" x 3 1/2" Rectangular Nozzle (10pcs) ■	16
59868-G	1/2" Y Fitting (20pcs) ■	12	61501	3/4" Hose Segment Pack (2pcs) ■	14	89225	Tapered Oval Nozzle (10pcs) ■	16
59869	1/2" to 1/4" Adapter (20pcs) ■	12	61502	3/4" Round Nozzle (4pcs) ■	14	89226	PVC Adapter for Vacuum (10pcs) ■	16
59869-BLK	1/2" to 1/4" Adapter (20pcs) ■	12	61503	5/8" Round Nozzle (4pcs) ■	14	89227	Sheet Metal Duct Adapter (10pcs) ■	16
59869-G	1/2" to 1/4" Adapter (20pcs) ■	12	61505	3/4" NPT Connector (4pcs) ■	14	89228	2 1/2" Slide Valve (10pcs) ■	16
59870	1/2" to 1/4" Y Reducer (20pcs) ■	12	61507	3" Flare Nozzle (2pcs) ■	14	89229	Shop Vacuum Hose Adapt. w/ Tab (10pcs) ■	16
59870-BLK	1/2" to 1/4" Y Reducer (20pcs) ■	12	61508	3/4" to 1/2" Adapter (2pcs) ■	14	89230	Shop Vacuum Adapter (10pcs) ■	16
59870-G	1/2" to 1/4" Y Reducer (20pcs) ■	12	61509	3/4" BSPT Connector (4pcs) ■	14	89320AS	2 1/2" ID AS Hose, 20 (1 ft Segments) ■	16
59871	2 1/2" Flare Nozzle (20pcs) ■	11	61511	3/4" Y Fitting (2pcs) ■	14	89323AS	4 1/2" AS Round Nozzle (10pcs) ■	16
59871-BLK	2 1/2" Flare Nozzle (20pcs) ■	11	61512	3/4" to 1/2" Y Reducer (2pcs) ■	14	89324AS	6" x 3 1/2" AS Rectangular Nozzle (10pcs) ■	16
59871-G	2 1/2" Flare Nozzle (20pcs) ■	11	61514	3/4" Double Socket (4pcs) ■	14	89325AS	AS Tapered Oval Nozzle (10pcs) ■	16
59872	1/2" Double Socket (20pcs) ■	12	61515	3/4" Elbow (2pcs) ■	14	89327AS	3" AS Sheet Metal Duct Adapter (10pcs) ■	16
59872-BLK	1/2" Double Socket (20pcs) ■	12	61516	3/4" Male NPT Valve (2pcs) ■	14	89328AS	2 1/2" AS Slide Valve (10pcs) ■	16
59872-G	1/2" Double Socket (20pcs) ■	12	61517	3/4" Female NPT Valve (2pcs) ■	14			



LOC-LINE[®]

THE ORIGINAL MODULAR HOSE SYSTEM

LOCKWOOD PRODUCTS, INC.

5615 Willow Lane
Lake Oswego, OR 97035 U.S.A.

PHONE: (800) 423-1625 or (503) 635-8113

FAX: (800) 472-8188 or (503) 635-2844

EMAIL: info@loc-line.com

WEB: www.loc-line.com