

SPECIAL? STANDARD MAGAFOR!

SPECIALIZATION

With more than 250 product groups and over 8,000 standard products, Magafor offers the solution adapted to each of your machining applications. For example, the 0,40mm diameter micro end-mill is available in 26 different lengths and styles! Who offers more? Styles, materials and lengths vary within each specific range of tooling to offer you the widest selection.

INNOVATION

To detect the needs created by new technologies – To analyze and compare the totality of the special tools which are required of us – To compare the heavy tendencies of the market – Such are the studies undertaken by Magafor to offer a standard answer, available with specific expectations of the most demanding customers.



MINIATURE TOOLING

Forever Magafor has chosen to manufacture small tools at the feasibility limit. Naturally its production program has shown a trend towards the micro-tools.

Micro-NC Spot Drills

Micro End-Mills

Micro-Reamers

PRODUCTIVITY

The multi-purpose concept is one of the recent major evolutions for machining operations. With its multi-function tools and tools for combined machining, Magafor emphasizes this evolution. These new concepts reduce the machining times, the number of tools needed and set-up time.

**Combined Machining
Multi-Function Tools**

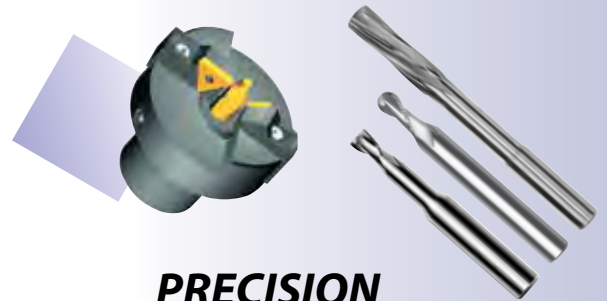

PRECISION

The miniaturization and the market requirements directed towards perfection have incited us to stock extensive series of standard items and an unrivalled range of types, forms, materials and coatings.

For Instance:

High Precision Micro Reamers available at every .0002" increment from .0078" to .0236" and every .0004 increment from .0240" to .7882"

Micro End-Mills available at every .0080" increment from .0020" to .2323"

magafor is the only cutting tool manufacturer member of the European Commission that has been chosen to research micro-machining.

*This research targets performance improvements of all **magafor** tools for the greatest profit margins for our customers.*



EDP NUMBERING SYSTEM

EDP # 86000181 - 1.81 mm
Solid Carbide High Precision
Micro Reamer

86000181
A B

A = Series # - 8600

Series # 8600 refers to Solid Carbide
High Precision Micro Reamers

B = Size - 1.81 mm

Size 0181 refers to 1.81 mm

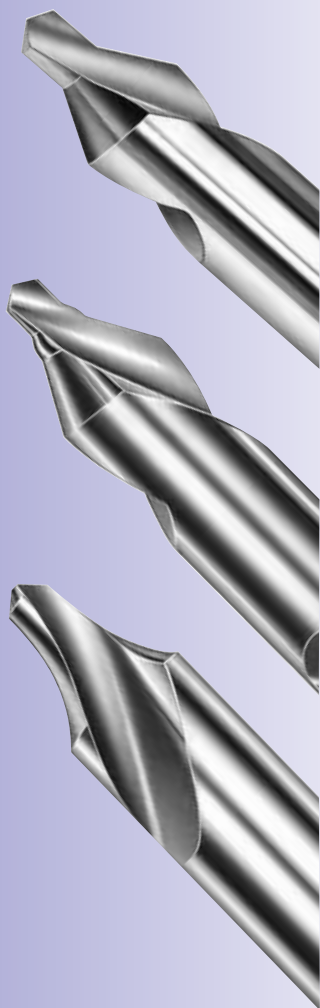

Note: Vickers Hardness Test
HV = a unit of hardness
given by the test known as
the Vickers Pyramid Number

SERIES INDEX

Code	Page	Code	Page	Code	Page	Code	Page
019	16	195	15	4811	21	8480	27
0919	16	196	15	4821	23	8480-H	27
019-L	16	197	16	4822	22	8490	27
0919-L	16	199	16	4824	22	8490-H	27
0290	7, 12	201	28	4831	24	8500	42-43
0291	12	202	28	4832	26	8500-G	42-43
0292	12	203	28	4834	26	8500-H	42-43
0811	8	2901	28	4837	24	8507	38
08115	5	2903	28	4933	25	8507-H	38
0890	7, 12	411	21	4936	25	8507-D	40
0891	12	412	21	8040	18	8507-DG	40
0895	15	413	21	8088	18	8507-DH	40
0896	15	414	21	8088-H	18	8510	44
0910	8	415	21	8090	18	8510-G	44
09105	5	416	21	8090-H	18	8510-H	44
0995	15	421	23	8092	18	8522-H	43
0996	15	422	22	8092-H	18	8527	38
10	8	423	23	8100	8	8527-H	38
105	8	424	22	8100-H	8	8527-D	39
1055	5	425	23	8190-H	14	8527-DG	39
11	7	430	26	8195	14	8527-DH	39
115	5	4303	25	8195-H	14	8527-L	39
118	6	431	24	8196	14	8529	41
125	11	432	26	8196-H	14	8529-G	41
135	10	433	26	8197	16	8529-H	41
145	9	434	26	8199	16	8550	45
154	6	435	26	8203-H	28	8600	32-37
155	6	436	25	8431	25	8610	31
16	7	437	24	8431-H	25		
185	6	438	26	8460	27		
191	15	439	26	8460-H	27		

COATINGS

Engaged right from the start in the process aspiring to excellence, in addition to our Futura and TiN coatings, MAGAFOR offers three new "X" coatings, sprung from multi-layer nano technology.

Red'X: cobalt tool coating with higher hardness of (3700 HV) like TiAlN in a multi-layer coating. This coating can be used for dry machining. Using coolant will add lubricity.

Hard'X: carbide tool coating with a high hardness (3500 HV) this coating shows a high thermic stability and an excellent protection against heat and wear. Ideal for dry machining-high speed cut-in treated steels and dies up to 67 Rc.

Graph'X: diamond coating (8000 HV) particularly effective to machine graphite, composite materials, plastics with glass-fibers or carbon-fibers.

MATERIALS USED IN THE MANUFACTURE OF OUR TOOLS AND COATINGS

DESIGNATION

magafor	europaen	american	japanese
HSS	HSS	M2	SKH-51
HSS-E COBALT	HSS-E	M35	SKH-55
HSS-E 8% COBALT	HSS-E8	M42	SKH-59
TiN	TiN	TiN	TiN
Futura	TiAlN	TiAlN	TiAlN
Red'X	TiAlN with higher hardness (3700 HV)		
Hard'X	AlTiN	(Exceed)	
Graph'X	Diamond coating		
K15 CARBIDE — 6.5 - 7% Cobalt (0,006 - 0,008mm grain size)			

Table of Contents

CENTERING – SPOTTING – COMBINED MACHINING

Plain Type 60° HSS & Cobalt Center Drills	5
HSS Long, 92°, 82° and JIS Center Drills.....	6
HSS, Cobalt & Carbide Metric Center Drills	7-8
Unique Bulge Style HSS Center Drills	9
Bell Type HSS Center Drills	10
Radius Type HSS Center Drills	11
Metric HSS-E Cobalt Flatted Center Drills for Combined Machining	12
Speeds & Feeds for Center Drills & NC Spot Drills	13
Carbide NC & Micro Spotting Drills / Multi-V 90°, 120° & 140°	14
Cobalt NC Spot Drills 60°, 90° & 120° and New! Red'X Coated	15
Long Series Cobalt & Carbide NC Spot Drills 90° & 120°	16
New! Duo-Mag = 2 Single End NC Spot Drills	16

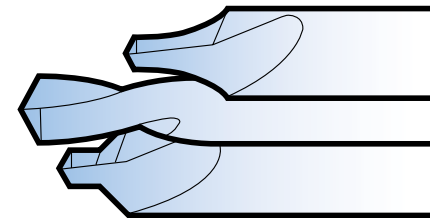

CENTERING-SPOTTING
COMBINED MACHINING
Page 4-16

MULTI-FUNCTION TOOLS "MULTI-V"

Micro & Multi-Function Tools "Multi-V" Carbide 90°	18
Multi-V Carbide 40°, 60° & 120°	18
Speeds & Feeds for Multi-V	19

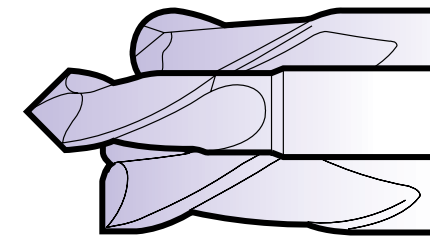

MULTI-FUNCTION TOOLS
Page 17-19

COUNTERSINKING

Countersinking & Deburring Information	20
Zero Flute Deburring Tool With Hole HSS-E Cobalt	21
Single Flute Chamfering Cutters Cobalt	22-23
Trident Three Flute Countersinks Cobalt 90°	24
Metric Three Flute Countersinks 90° Cobalt & Carbide – Long Series	25
Metric Three Flute Countersinks Cobalt 30°, 60°, 82°, 100° & 120°	26
Trident Hand Countersinks and Universal Auto-Lock Chuck Handles	26
New! Bi-Face Chamfering Biconical Cutters.....	27
Spotweld Drills Short & Long Series Cobalt & Carbide	28
Speeds & Feeds for Deburring, Chamfering & Three Flute Countersinks... 29	

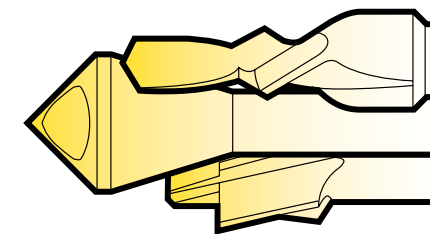

COUNTERSINKING
Page 20-29

HIGH PRECISION MICRO & MINIATURE REAMERS

Reamer Information Page	30
Carbide Micro-Reamers	31
Carbide Miniature Reamers	32-37
Reamer Formulas for Speeds & Feeds	37

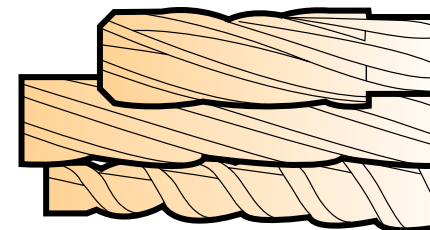

REAMING
Page 30-37

MICRO END-MILLS

Miniature Ball End & Square End Carbide End-Mills 1.5 x Diameter	38
Miniature Ball End With Back Clearance Carbide End-Mills	39
Miniature Square End With Back Clearance Carbide End-Mills	40
Miniature Ball End Carbide End-Mills	41
Standard Length Carbide End-Mills & Long Series	42-43
220° Ball End Miniature End-Mills With Back Clearance	43
Extra Long Carbide End-Mills	44
Miniature Round Corner Carbide End-Mills	45
Speeds & Feeds for End-Mills	46

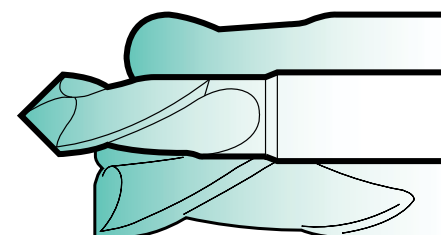

MICRO-MILLING
Page 38-46

SPECIALS FORMS

Special Center Drill Form	47
Special Reamer Form	48

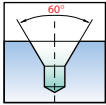
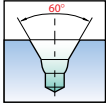
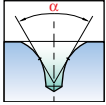
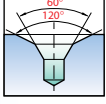
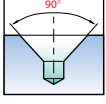

CENTERING

FORMS	RIGHT HAND CUT			LEFT HAND CUT
	SHORT	WITH FLAT	LONG	
 A	Pages 5, 7, 8	Page 12	Page 6	Page 7
 W	Page 9			
 R	Page 11	Page 12		
 B	Page 10	Page 12		
 82° 90°	Page 6			

SPOTTING

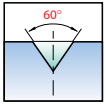
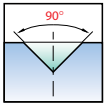
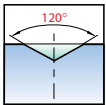
 60°	Page 15		
 90°	Pages 14-15		Page 16
 120° 140°	Pages 14-15		Page 16

COMBINED MACHINING

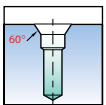
 A	Pages 12		
--	-------------	--	--



*Call for more information on modul-R centering head

PLAIN TYPE 60° CENTER DRILLS Sizes in inches

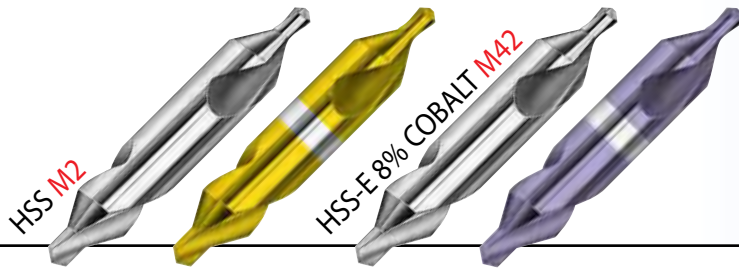

SIZE	D	d	L	l	115	M2/TIN 08115	Cobalt + 1055	M42/futura 091055
00000	1/8	.010	1-1/4	.008 - .018			1055005*	091055005*
0000	1/8	.015	1-1/4	.014 - .025	1150004	08115004	1055004*	091055004*
000	1/8	.020	1-1/4	.020 - .032	1150001	08115001	1055001*	091055001*
00	1/8	.025	1-1/4	.028 - .040	1150002	08115002	1055002*	091055002*
0	1/8	1/32	1-1/4	.035 - .047	1150003	08115003	1055003*	091055003*
1	1/8	3/64	1-1/4	.055 - .067	1150100	08115010	1055010	091055010
2	3/16	5/64	1-7/8	.095 - .106	1150200	08115020	1055020	091055020
3	1/4	7/64	2	.130 - .154	1150300	08115030	1055030	091055030
4	5/16	1/8	2-1/8	.150 - .175	1150400	08115040	1055040	091055040
4-1/2	3/8	9/64	2-1/2	.170 - .193	1150450	08115045		
5	7/16	3/16	2-3/4	.230 - .256	1150500	08115050	1055050	091055050
6	1/2	7/32	3	.270 - .295	1150600	08115060	1055060	091055060
7	5/8	1/4	3-1/4	.315 - .340	1150700	08115070	1055070	091055070
8	3/4	5/16	3-1/2	.390 - .420	1150800	08115080	1055080	091055080
9	7/8	11/32	3-5/8	.430 - .460	1150900	08115090		
10	1	3/8	3-3/4	.475 - .500	1151000	08115100		

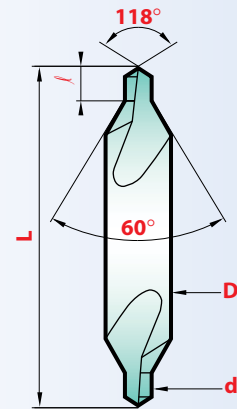
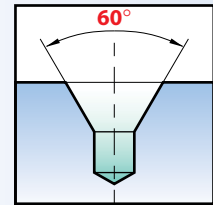

Tolerances

Tool Diameters	D	d	Angle 60° 118°
.010 - 7/64	n/a	+ .0039	
1/8 - 7/32	-.0007	+ .0047	
1/4 - 3/8	-.0009	+ .0059	- 30' ± 2°
7/16 - 5/8	-.0011	n/a	
3/4 - 1	-.0013	n/a	

Please Note: *Single end tool

Value SETS American Standard

5 PIECES



COMPOSITION Quantity	HSS S115	COMPOSITION Quantity	Cobalt S1055
1 piece each	# 1	1 piece each	# 1
	# 2		# 2
	# 3		# 3
	# 4		# 4
	# 5		# 5

Sets also available TIN coated

Longs

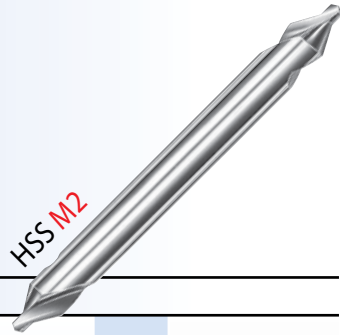

SIZE	D	d	L	185
1 x 3"	1/8	3/64	3	1850103
1 x 4"			4	1850104
1 x 5"			5	1850105
1 x 6"			6	1850106
2 x 3"	3/16	5/64	3	1850203
2 x 4"			4	1850204
2 x 5"			5	1850205
2 x 6"			6	1850206
3 x 3"	1/4	7/64	3	1850303
3 x 4"			4	1850304
3 x 5"			5	1850305
3 x 6"			6	1850306
4 x 3"	5/16	1/8	3	1850403
4 x 4"			4	1850404
4 x 5"			5	1850405
4 x 6"			6	1850406
4-1/2 x 4"	3/8	9/64	4	1850454
4-1/2 x 5"			5	1850455
4-1/2 x 6"			6	1850456
5 x 4"	7/16	3/16	4	1850504
5 x 5"			5	1850505
5 x 6"			6	1850506
6 x 4"	1/2	7/32	4	1850604
6 x 5"			5	1850605
6 x 6"			6	1850606
7 x 5"	5/8	1/4	5	1850705
7 x 6"			6	1850706
8 x 6"	3/4	5/16	6	1850806

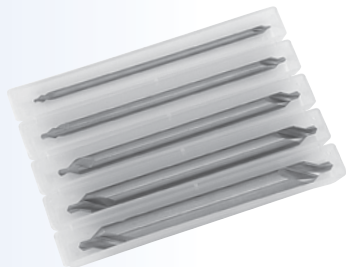

Value SETS American Standard

5 PIECES / Longs = 4"

COMPOSITION magafor S185 Long

1 - 2 - 3 - 4 - 5 Long 1 piece of each

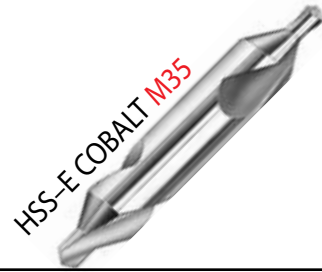

In Metric Old Japanese Standard

D x d	L	ℓ	magafor 118
4,0 x 1,0	35	1,2 - 1,5	11804100
5,0 x 1,2	40	1,3 - 1,8	11805120
5,0 x 1,5	40	1,5 - 2,0	11805150
6,0 x 2,0	45	2,0 - 2,5	11806200
7,7 x 2,5*	50	2,5 - 3,0	11807725
7,7 x 2,5*	57	2,5 - 3,0	118077251
7,7 x 3,0	56	3,0 - 3,6	11807730
7,7 x 3,2	57	3,2 - 3,8	11807732
10,0 x 4,0*	65	4,5 - 5,1	11810400
10,0 x 4,0*	69	4,5 - 5,1	118104001
11,0 x 4,0	69	4,5 - 5,1	11811400
11,0 x 5,0*	69	5,5 - 6,1	11811500
11,0 x 5,0*	78	5,5 - 6,1	118115001
18,0 x 6,0	95	7,0 - 8,0	11818600

*Overall length "L" has to be mentioned

82° - 90° Angles

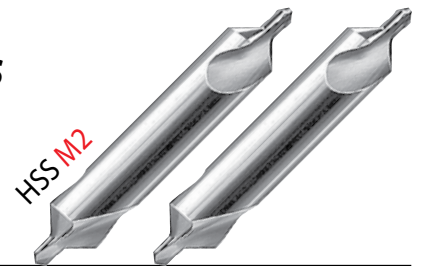

SIZE	Angle			82°	90°	
	D	d	L	154	155	
1	1/8	3/64	1-1/4	.055 - .067	1540100	1550100
2	3/16	5/64	1-7/8	.095 - .106	1540200	1550200
3	1/4	7/64	2	.130 - .154	1540300	1550300
4	5/16	1/8	2-1/8	.150 - .175	1540400	1550400
5	7/16	3/16	2-3/4	.230 - .256	1540500	1550500
6	1/2	7/32	3	.270 - .295	1540600	1550600
7	5/8	1/4	3-1/4	.315 - .340	1540700	1550700
8	3/4	5/16	3-1/2	.390 - .420	1540800	1550800

METRIC CENTER DRILLS 60° Angle Form A

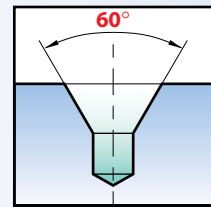

ISO • NFE 66051-A • DIN 333-A • JIS-1 In Metric

TYPE			Right hand	Left hand	With flat, right hand		
D x d	L	ℓ	11	16	P -0,1	Cobalt 0290	M35/TIN 0890
3,0 x 0,5	31	0,6 - 0,9	1103000050				
3,15 x 0,5*	25	0,6 - 0,9	1103150050	1603150050			
3,15 x 0,63*	25	0,7 - 1,0	1103150063	1603150063			
3,15 x 0,8*	25	1,0 - 1,3	1103150080	1603150080			
3,15 x 1,0	31	1,3 - 1,7	1103150100	1603150100			
3,15 x 1,25	31	1,6 - 2,0	1103150125	1603150125			
3,5 x 0,75	35	1,0 - 1,3	1103500075	1603500075			
4,0 x 1,0	35	1,3 - 1,7	1104000100	1604000100			
4,0 x 1,25	35	1,6 - 2,0	1104000125	1604000125			
4,0 x 1,6	35	2,0 - 2,6	1104000160	1604000160	3,25	02900400160	08900400160
5,0 x 1,5	40	2,0 - 2,6	1105000150	1605000150			
5,0 x 1,6	40	2,0 - 2,6	1105000160	1605000160			
5,0 x 2,0	40	2,5 - 3,1	1105000200	1605000200	4,20	02900500200	08900500200
6,0 x 2,0	45	2,5 - 3,1	1106000200	1606000200			
6,3 x 2,0	45	2,5 - 3,1	1106300200	1606300200			
6,3 x 2,5	45	3,1 - 3,8	1106300250	1606300250	5,35	02900630250	08900630250
8,0 x 2,5	50	3,1 - 3,8	1108000250	1608000250			
8,0 x 3,0	50	3,9 - 4,6	1108000300	1608000300			
8,0 x 3,15	50	3,9 - 4,6	1108000315	1608000315	6,95	02900800315	08900800315
10,0 x 3,0	55	3,9 - 4,6	1110000300	1610000300			
10,0 x 3,15	55	3,9 - 4,6	1110000315	1610000315			
10,0 x 4,0	55	5,0 - 5,9	1110000400	1610000400	8,40	02901000400	08901000400
12,0 x 4,0	63	5,0 - 5,9	1112000400	1612000400			
12,0 x 5,0	63	6,3 - 7,2	1112000500	1612000500			
12,5 x 4,0	63	5,0 - 5,9	1112500400	1612500400			
12,5 x 5,0	63	6,3 - 7,2	1112500500	1612500500	10,95	02901250500	08901250500
14,0 x 5,0	69	6,3 - 7,2	1114000500	1614000500			
16,0 x 5,0	71	6,3 - 7,2	1116000500	1616000500			
16,0 x 6,3	71	8,0 - 8,9	1116000630	1616000630	14,00	02901600630	08901600630
18,0 x 6,0	77	8,0 - 8,9	1118000600				
20,0 x 6,3	80	8,0 - 8,9	1120000630				
20,0 x 8,0	80	10,1 - 11,1	1120000800	1620000800	17,90	02902000800	08902000800
25,0 x 8,0	100	10,1 - 11,1	1125000800				
25,0 x 10,0	100	12,8 - 13,8	1125001000		22,50	02902501000	08902501000
31,5 x 10,0	125	12,8 - 13,8	1131501000				
31,5 x 12,5	125	16,5 - 17,5	1131501250				

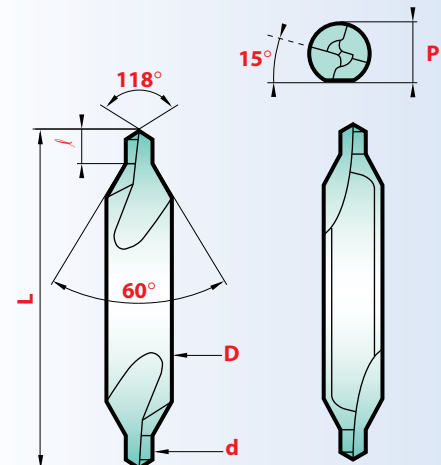

Tolerances

D	d	L	Angles	
			60°	118°
h8	k12	±1	-30'	±2°

The **magafor** center drills are particularly effective thanks to their unique ground spiral flutes.

Special attention to concentricity of drill diameter to body makes us superior to others.

* Single end

NOTE: all metric center drills are available within 2 weeks.
Call for information.

Performances

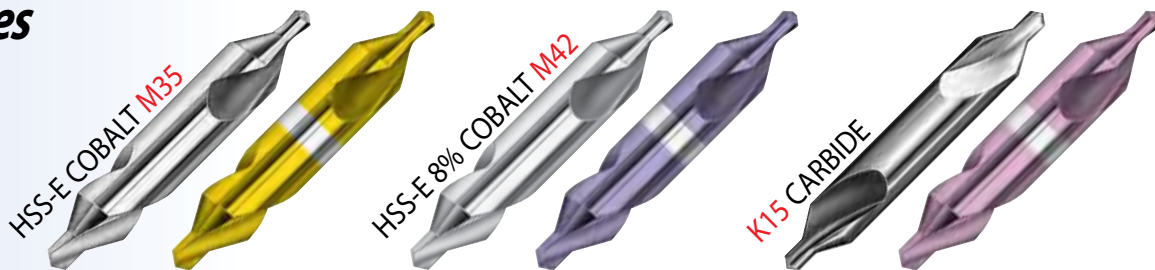

ISO • NFE 66051-A • DIN 333-A • JIS-1

In Metric

D x d	L	λ	magafor 10	M35/TIN 0811	cobalt 105	M42/futura 0910	carbide 8100	K15/Hard'X 8100-H
3,15 x 0,5*	25	0,6 - 0,9		08110315050			81000315050	81000315050-H
3,15 x 0,8*	25	1,0 - 1,3		08110315080			81000315080	81000315080-H
3,15 x 1,0	31	1,3 - 1,7	100315100	08110315100	1050315100	0910315100	81000315100	81000315100-H
3,15 x 1,25	31	1,6 - 2,0	100315125	08110315125	1050315125	0910315125	81000315125	81000315125-H
3,5 x 0,75	35	1,0 - 1,3	100350075	08110350075				
4,0 x 1,0	35	1,3 - 1,7	100400100	08110400100			81000400100	81000400100-H
4,0 x 1,6	35	2,0 - 2,6	100400160	08110400160	1050400160	0910400160	81000400160	81000400160-H
5,0 x 1,5	40	2,0 - 2,6	100500150	08110500150			81000500150	81000500150-H
5,0 x 2,0	40	2,5 - 3,1	100500200	08110500200	1050500200	0910500200	81000500200	81000500200-H
6,0 x 2,0	45	2,5 - 3,1	100600200	08110600200			81000600200	81000600200-H
6,3 x 2,5	45	3,1 - 3,8	100630250	08110630250	1050630250	0910630250	81000630250	81000630250-H
8,0 x 2,5	50	3,1 - 3,8	100800250	08110800250			81000800250	81000800250-H
8,0 x 3,0	50	3,9 - 4,6	100800300	08110800300			81000800300	81000800300-H
8,0 x 3,15	50	3,9 - 4,6	100800315	08110800315	1050800315	0910800315	81000800315	81000800315-H
10,0 x 3,0	55	3,9 - 4,6	101000300	08111000300			81001000300	81001000300-H
10,0 x 4,0	55	5,0 - 5,9	101000400	08111000400	1051000400	0910000400	81001000400	81001000400-H
12,0 x 4,0	63	5,0 - 5,9	101200400	08111200400				
12,0 x 5,0	63	6,3 - 7,2	101200500	08111200500			81001200500	81001200500-H
12,5 x 5,0	63	6,3 - 7,2	101250500	08111250500	1051250500	0910250500	81001250500	81001250500-H
14,0 x 5,0	69	6,3 - 7,2	101400500	08111400500				
16,0 x 6,3	71	8,0 - 8,9		08111600630			81001600630	81001600630-H
20,0 x 8,0	80	10,1 - 11,1		08112000800				

* Single end

K15 CARBIDE — 6.5 - 7% Cobalt (0.006 - 0.008mm grain size)

NOTE: all metric center drills are available within 2 weeks. Call for information.



**The Largest Manufacturer of Center Drills World Wide,
With Over 4 Million Units Sold Annually.**

**Our European Catalogue Promotes 19 Pages of Combined Drills and Countersinks for
World Wide Consumption.**



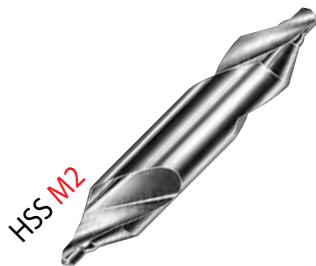

magafor

"UNIQUE"
CENTER DRILLS
With reinforcing bulge
Form W

PLAIN TYPE WITH BULGE

SIZE	D	d	L	ℓ	145
1 - W	1/8	3/64	1-1/4	.055 - .067	1450100
2 - W	3/16	5/64	1-7/8	.095 - .106	1450200
3 - W	1/4	7/64	2	.130 - .154	1450300
4 - W	5/16	1/8	2-1/8	.150 - .175	1450400
5 - W	7/16	3/16	2-3/4	.230 - .256	1450500
6 - W	1/2	7/32	3	.270 - .295	1450600
7 - W	5/8	1/4	3-1/4	.315 - .340	1450700
8 - W	3/4	5/16	3-1/2	.390 - .420	1450800

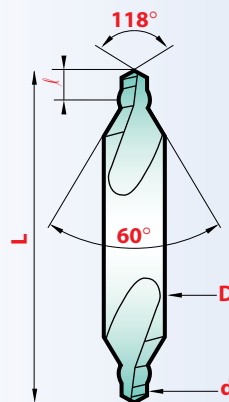
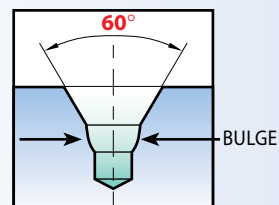

The **magafor** center drill form W is stronger than the common center drill :

- the bulge reinforces the point,
- it increases the chips removal,
- it makes the lubrication of the drill easier,
- runs at faster speeds and feeds.

Tolerances

Tool Diameters	D	d	Angle	
			60°	118°
.010 - 7/64	n/a	+ .0039		
1/8 - 7/32	- .0007	+ .0047		
1/4 - 3/8	- .0009	+ .0059	- 30'	± 2°
7/16 - 5/8	- .0011	n/a		
3/4 - 1	- .0013	n/a		

Form W SETS

American Standard

5 PIECES

COMPOSITION	Quantity	S145
1 piece each Bulge	# 1-W	
	# 2-W	
	# 3-W	
	# 4-W	
	# 5-W	



BELL TYPE CENTER DRILLS With saved angle Form B

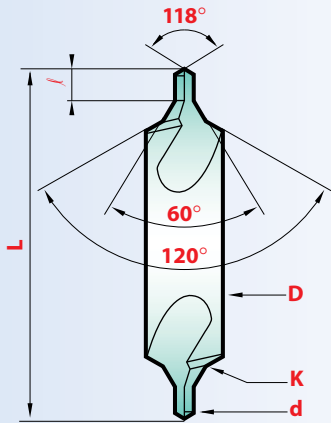
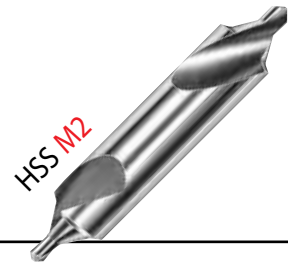
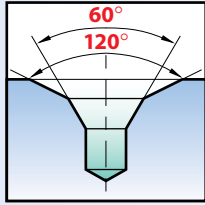

SIZE	D	d	K	L	ℓ	135
11	1/8	3/64	.100	1-1/4	.055 - .070	1351100
12	3/16	1/16	.150	1-7/8	.070 - .090	1351200
13	1/4	3/32	.200	2	.110 - .135	1351300
14	5/16	7/64	.250	2-1/8	.125 - .155	1351400
15	7/16	5/32	.350	2-3/4	.185 - .215	1351500
16	1/2	3/16	.400	3	.230 - .260	1351600
17	5/8	7/32	.500	3-1/4	.270 - .300	1351700
18	3/4	1/4	.600	3-1/2	.310 - .340	1351800
19	7/8	5/16	.700	3-5/8	.390 - .420	1351900
20	1	3/8	.800	3-3/4	.470 - .500	1352000

Tolerances

Tool Diameters	D	d	Angle		
			60°	118°	120°
.010 - 7/64	n/a	+.0039			
1/8 - 7/32	-.0007	+.0047			
1/4 - 3/8	-.0009	+.0059	-30' ± 2°		-4°
7/16 - 5/8	-.0011	n/a			
3/4 - 1	-.0013	n/a			

Center drills with protective chamfer guarantee the center obtained from any risk of blows and deformation. The splay resulting from the protective chamfer makes it easier to load parts between points on machines with automatic feed.

Form B SETS American Standard

5 PIECES

COMPOSITION Quantity	S135
1 piece each Bell Type	# 11
	# 12
	# 13
	# 14
	# 15



RADIUS TYPE CENTER DRILLS Form R

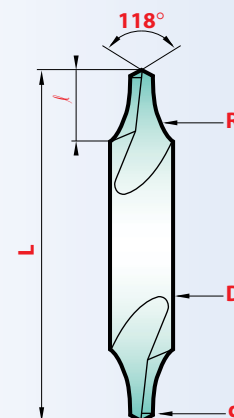
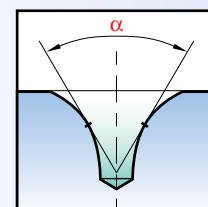
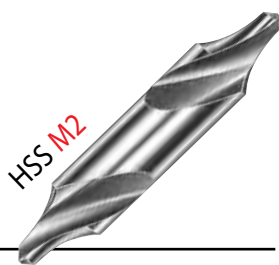

ASA #	D	d	L	R	ℓ	magafor 125
1 - R	1/8	3/64	1-1/4	.150	.125 - .150	1250100
2 - R	3/16	5/64	1-7/8	.230	.200 - .225	1250200
3 - R	1/4	7/64	2	.315	.270 - .300	1250300
4 - R	5/16	1/8	2-1/8	.400	.340 - .370	1250400
5 - R	7/16	3/16	2-3/4	.500	.480 - .510	1250500
6 - R	1/2	7/32	3	.530	.540 - .575	1250600
7 - R	5/8	1/4	3-1/4	.700	.660 - .700	1250700
8 - R	3/4	5/16	3-1/2	.790	.810 - .850	1250800

magafor center drill with radius, thanks to its special profile, is more robust than the 60° center drill:

- the radius eliminates the risk of breakage,
- it provides an exact bearing,
- it serves as a protective chamfer.

Tolerances

Tool Diameters	D	d	R max
.010 - 7/64	n/a	+ .0039	
1/8 - 7/32	- 0.0007	+ .0047	
1/4 - 3/8	- 0.0009	+ .0059	1.25 R
7/16 - 5/8	- 0.0011	n/a	
3/4 - 1	- 0.0013"	n/a	



Form R SETS American Standard

5 PIECES

COMPOSITION Quantity	S125
1 piece each Radius Type	# 1-R
	# 2-R
	# 3-R
	# 4-R
	# 5-R

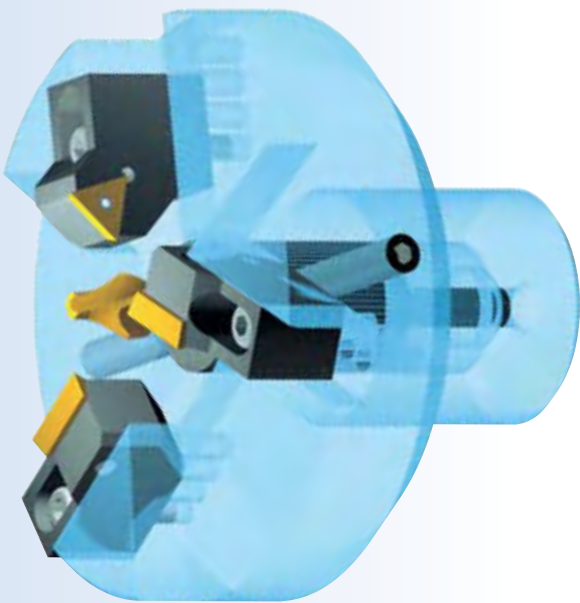

modul-R

CENTERING HEADS

The new **modul-R** center head allows to center, to face and to chamfer the surface at the same time :

- constant depth of the centers,
- reduced machining times,
- less tools and change of tools,
- simple, rigid concept designed for middle and large series,
- inexpensive even for small series.

Application : for machining the ends of bars, axles, shafts and tubes.

Capacity : flexible modular system for centers into bars from 1/4" to 2".

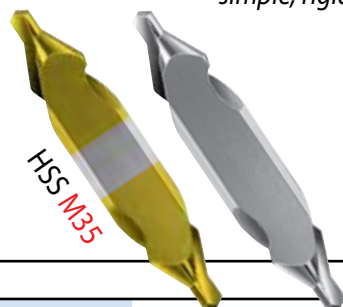

NOTE: call for further information and pricing on the **modul-R**.

METRIC PLAIN TYPE CENTER DRILLS

D x d	L	ℓ	FLAT	Cobalt 0290	TIN 0890
4,0 x 1,6	35	1,0 - 2,4	3,25	02900400160	08900400160
5,0 x 2,0	40	2,5 - 2,9	4,20	02900500200	08900500200
6,3 x 2,5	45	3,1 - 3,6	5,35	02900630250	08900630250
8,0 x 3,15	50	3,9 - 4,4	6,95	02900800315	08900800315
10,0 x 4,0	55	5,0 - 5,6	8,40	02901000400	08901000400
12,5 x 5,0	63	6,3 - 6,9	10,95	02901250500	08901250500
16,0 x 6,3	71	8,0 - 8,6	14,00	02901600630	08901600630
20,0 x 8,0	80	10,1 - 10,8	17,90	02902000800	08902000800
25,0 x 10,0	100	12,8 - 13,5	22,50	02902501000	08902501000

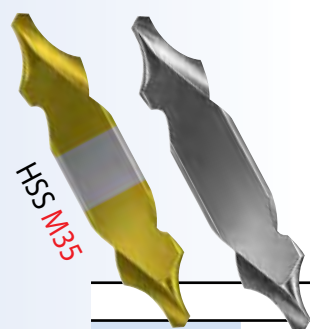

NOTE: all metric center drills are available within 2 weeks. Call for information and pricing.

METRIC RADIUS TYPE CENTER DRILLS

D x d	L	R	ℓ	FLAT	Cobalt 0291	TIN 0891
4,0 x 1,6	35	4,0	4,2 - 4,7	3,25	0291040160	0891040160
5,0 x 2,0	40	5,0	5,0 - 5,4	4,20	0291050200	0891050200
6,3 x 2,5	45	6,3	6,3 - 6,8	5,35	0291063250	0891063250
8,0 x 3,15	50	8,0	8,0 - 8,5	6,95	0291080315	0891080315
10,0 x 4,0	55	10,0	10,0 - 10,6	8,40	0291100400	0891100400
12,5 x 5,0	63	12,5	12,5 - 13,1	10,95	0291125500	0891125500
16,0 x 6,3	71	16,0	16,0 - 16,6	14,00	0291160630	0891160630
20,0 x 8,0	80	20,0	20,0 - 20,7	17,90	0291200800	0891200800

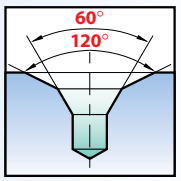

Form B
Protected center

METRIC BELL TYPE CENTER DRILLS Form B

D x d	L	K	ℓ	FLAT	Cobalt 0292
6,3 X 1,6	45	3,3	2,0 - 2,4	5,35	02920630160
8,0 x 2,0	50	4,2	2,5 - 2,9	6,95	02920800200
10,0 x 2,5	55	5,3	3,1 - 3,6	8,40	02921000250
11,2 x 3,15	63	6,7	3,9 - 4,4	10,00	02921120315
14,0 x 4,0	69	8,5	5,0 - 5,6	12,65	02921400400
18,0 x 5,0	77	10,6	6,3 - 6,9	16,40	02921800500
20,0 x 6,3	80	13,2	8,0 - 8,6	17,90	02922000630
25,0 x 8,0	100	17,0	10,1 - 10,8	22,50	02922500800
31,5 x 10,0	125	21,2	12,8 - 13,5	28,40	02923151000

Form A

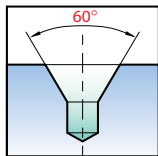

Most universal center drill.
60° angle
Standard center.
118° point

Form R

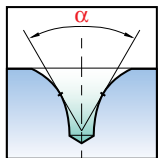

The radius eliminates the risk of breakage,
and is more robust than the 60° drill.
Provides an exact bearing surface.
Serves as a protective chamfer.
118° point

Form W

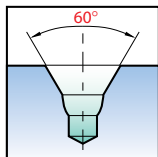

The bulge reinforces the point.
Increases chip removal.
Makes the lubrication of the drill easier.
118° point

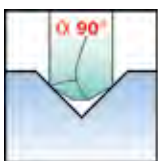

90° NC Spot Drill
By using the **magafor NC** drill of
diameter over the drilling tool,
centering and chamfering are
obtained in a single operation.



120° & 140° NC Spot Drill
The preliminary hole obtained with the
magafor NC drill corresponds to the angle
at the end of the tool used in drilling and
prevents it from deviating.

RECOMMENDATIONS FOR THE USE OF CENTER DRILLS AND NC SPOT DRILLS

- SFM:** Surface Feet per Minute
- RPM:** Revolutions per Minute
- IPT:** Inches per Tooth (chip load)
- IPM:** Inches per Minute
- IPR:** Inches per Revolution

Speed Formula:

$$RPM = 3.82 \times (SFM \div \text{Diameter})$$

$$\text{Feed: } IPM = IPT \times \# \text{ of Flutes} \times RPM$$

$$IPR = IPM \div RPM$$

$$SFM = RPM \times \text{Diameter} \div 3.82$$

FORMULA FOR SPEED (RPM)

Example	#1 Center Drill (.078) Cutting Soft Material: < 81 HRB
	SFM = 148 for 5/64 Ø HSS
	RPM = 3.82 x (148 ÷ .0787) = 7180
	IPM = .001 x 2 x 7180 = 14.36
	IPR = 14.36 ÷ 7180 = .002

MATERIAL	
	< 81 HRB (B)
STEEL-:	< 24 Rc (C)
	24 - 32 Rc
	32 - 41 Rc
	Stainless Steel/Titanium
	Inconel/Nimonic/Waspaloy
	Brass/Copper
	Copper Alloys/Bronze
	Aluminum
	Hardened Aluminum < 6% Si
	Cast Aluminum > 6% Si
	Thermoplastics

HSS						
SFM	FEED inch/rev					
	2mm 5/64	3mm 1/8	6mm 1/4	10mm 3/8	16mm 5/8	
99 - 148	.0020	.0024	.0031	.0059	.0079	
82 - 99						
49 - 82						
33 - 49	.0012	.0016	.0024	.0039	.0059	
20 - 33						
16 - 20	.0008	.0012	.0020	.0028	.0039	
132 - 197						
99 - 132	.0020	.0028	.0035	.0059	.0079	
494 - 658	.0031	.0039	.0079	.0157	.0197	
197 - 329	.0024	.0031	.0039	.0059	.0098	
132 - 197						
329 - 428	.0031	.0035	.0079	.0138	.0157	

TIN						
SFM	FEED inch/rev					
	2mm 5/64	3mm 1/8	6mm 1/4	10mm 3/8	16mm 5/8	
197 - 296	.0031	.0035	.0047	.0098	.0118	
165 - 230						
115 - 148						
82 - 99	.0020	.0024	.0035	.0055	.0087	
39 - 53						
33 - 43	.0016	.0020	.0028	.0039	.0059	
362 - 428						
263 - 362	.0028	.0035	.0055	.0106	.0142	
1152 - 1481	.0047	.0055	.0118	.0217	.0256	
395 - 592	.0031	.0039	.0059	.0118	.0157	
263 - 395						
658 - 855	.0047	.0055	.0118	.0217	.0256	

MATERIAL	
	< 81 HRB (B)
STEEL-:	< 24 Rc (C)
	24 - 32 Rc
	32 - 41 Rc
	Stainless Steel/Titanium
	Inconel/Nimonic/Waspaloy
	Brass/Copper
	Copper Alloys/Bronze
	Aluminum
	Hardened Aluminum < 6% Si
	Cast Aluminum > 6% Si
	Thermoplastics

Futura/Red'X						
SFM	FEED inch/rev					
	2mm 5/64	3mm 1/8	6mm 1/4	10mm 3/8	16mm 5/8	
296 - 395	.0039	.0047	.0063	.0118	.0177	
247 - 329						
165 - 214						
99 - 214	.0028	.0031	.0047	.0071	.0110	
59 - 79						
49 - 66	.0020	.0024	.0039	.0055	.0079	
428 - 494						
362 - 428	.0039	.0047	.0071	.0142	.0197	
1645 - 2300	.0063	.0071	.0157	.0295	.0354	
592 - 823	.0039	.0047	.0071	.0142	.0197	
395 - 559						
987 - 1316	.0063	.0071	.0157	.0295	.0354	

CARBIDE						
SFM	FEED inch/rev					
	2mm 5/64	3mm 1/8	6mm 1/4	10mm 3/8	16mm 5/8	
362 - 461	.0047	.0055	.0079	.0138	.0217	
296 - 362						
197 - 263						
115 - 165	.0035	.0039	.0055	.0087	.0094	
72 - 99						
63 - 82	.0031	.0028	.0047	.0067	.0094	
494 - 592						
428 - 494	.0047	.0055	.0087	.0173	.0240	
1974 - 2632	.0039	.0087	.0193	.0354	.0374	
658 - 987						
461 - 658	.0047	.0055	.0087	.0173	.0240	
1217 - 1579	.0079	.0087	.0193	.0354	.0374	

NC SPOTTING DRILLS

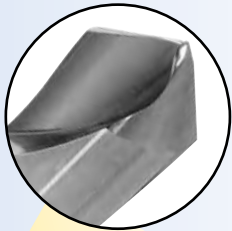
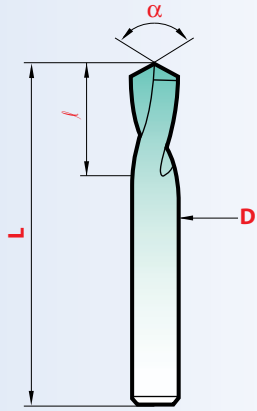

STANDARD WEB THINNING "SPLIT-POINT" FEATURE FOR HIGH SPEED CUTTING



Diameter		Angle			90°		120°		140°†
inch	mm	L	l	T*	Carbide 8195	K15/Hard'X 8195-H	Carbide 8196	K15/Hard'X 8196-H	K15/Hard'X 8190-H
.078	2	1-9/16	.315	.008	81950200	81950200-H	81960200	81960200-H	
.118	3	1-3/4	.400	.012	81950300	81950300-H	81960300	81960300-H	
.157	4	2	.475	.016	81950400	81950400-H	81960400	81960400-H	
.197	5	2	.600	.020	81950500	81950500-H	81960500	81960500-H	
.236	6	2	.700	.023	81950600	81950600-H	81960600	81960600-H	81900600-H
1/4		2	.700	.023	81950635	81950635-H	81960635	81960635-H	81900635-H
5/16		2-3/8	.900	.031	81950793	81950793-H			
.315	8	2-3/8	.900	.031	81950800	81950800-H	81960800	81960800-H	81900800-H
3/8		2-3/4	.950	.039	81950952	81950952-H	81960952	81960952-H	81900952-H
.394	10	2-3/4	.950	.039	81951000	81951000-H	81961000	81961000-H	81901000-H
.472	12	2-3/4	.950	.047	81951200	81951200-H	81961200	81961200-H	81901200-H
1/2		2-3/4	.950	.051	81951270	81951270-H	81961270	81961270-H	81901270-H
.551	14	3	.950	.055	81951400	81951400-H	81961400	81961400-H	
5/8		3-1/8	1	.063	81951587	81951587-H	81961587	81961587-H	81901587-H
.630	16	3-1/8	1	.063	81951600	81951600-H	81961600	81961600-H	81901600-H
.787	20	4	1-3/8	.079	81952000	81952000-H	81962000	81962000-H	

T* = web thickness of split point

† 140 degree angle : for hard alloys and high performance drilling

K15 CARBIDE — 6.5 - 7% Cobalt (0.006 - 0.008mm grain size)

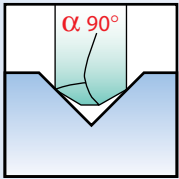

90 degree angle :
By using the **magafor NC** drill of diameter over the drilling tool, centering and chamfering are obtained in a single operation.

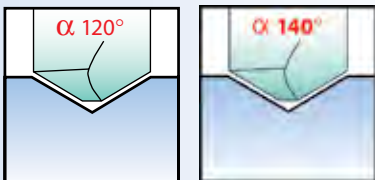

120 and 140 degree angles :
The preliminary hole obtained with the **magafor NC** drill corresponds to the angle at the end of the tool used in drilling and prevents it from drifting and allowing the drill point to cut first.

Micro Range of Carbide MINIATURE NC SPOTTING DRILLS MULTI-V®

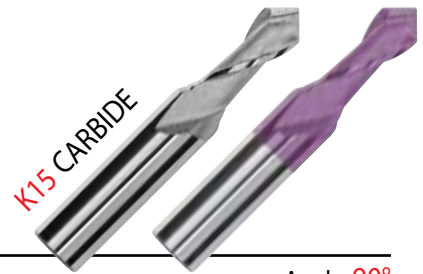

STANDARD magafor						Angle 90°	
Diameter		L	l	d2	T*	MULTI-V 8090	K15/Hard'X 8090-H
inch	mm						
.020	0,5	1-1/2	.040	.118	.002	80900050	80900050-H
.024	0,6	1-1/2	.047	.118	.002	80900060	80900060-H
.028	0,7	1-1/2	.055	.118	.003	80900070	80900070-H
.031	0,8	1-1/2	.063	.118	.003	80900080	80900080-H
.035	0,9	1-1/2	.071	.118	.003	80900090	80900090-H
.039	1,0	1-1/2	.080	.118	.004	80900100	80900100-H
.047	1,2	1-1/2	.095	.118	.005	80900120	80900120-H
.055	1,4	1-1/2	.110	.118	.006	80900140	80900140-H
.059	1,5	1-1/2	.120	.118	.006	80900150	80900150-H
.063	1,6	1-1/2	.125	.118	.006	80900160	80900160-H
.071	1,8	1-1/2	.140	.118	.007	80900180	80900180-H
.078	2,0	1-1/2	.160	.118	.008	80900200	80900200-H

T* = web thickness of split point

See the full line and more detail on pages 17-19

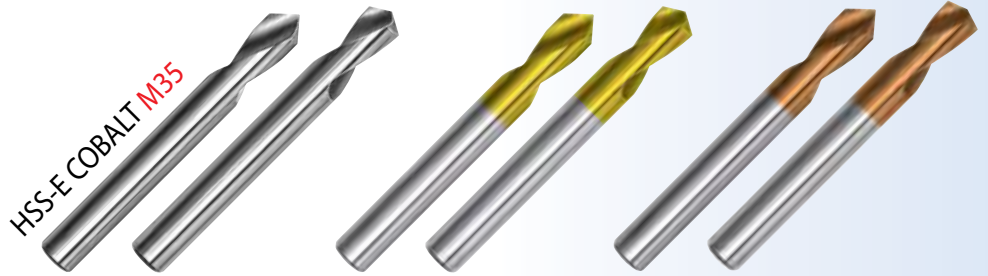

Angle					60°	90°	120°	90°	120°	90°	120°
Diameter		L	ℓ	T	Cobalt 191	Cobalt 195	Cobalt 196	M35/TIN 0895	M35/TIN 0896	M35/Red'X 0995*	M35/Red'X 0996*
inch	mm										
.078	2	2	.315	.008		1950200	1960200	08950200	08960200	09950200	09960200
.118	3	2	.400	.012		1950300	1960300	08950300	08960300	09950300	09960300
1/8		2	.400	.012		1950317	1960317	08950317	08960317	09950317	09960317
.157	4	2-1/16	.475	.016	1910400	1950400	1960400	08950400	08960400	09950400	09960400
3/16		2-3/8	.600	.020		1950476	1960476	08950476	08960476	09950476	09960476
.197	5	2-3/8	.600	.020	1910500	1950500	1960500	08950500	08960500	09950500	09960500
.236	6	2-5/8	.800	.023	1910600	1950600	1960600	08950600	08960600	09950600	09960600
1/4		2-5/8	.900	.025		1950635	1960635	08950635	08960635	09950635	09960635
5/16		3-1/8	1	.031		1950793		08950793			
.315	8	3-1/8	1	.031	1910800	1950800	1960800	08950800	08960800	09950800	09960800
3/8		3-1/2	1	.039		1950952	1960952	08950952	08960952	09950952	09960952
.394	10	3-1/2	1	.039	1911000	1951000	1961000	08951000	08961000	09951000	09961000
.472	12	4	1-1/4	.047	1911200	1951200	1961200	08951200	08961200	09951200	09961200
1/2		4	1-3/8	.051		1951270	1961270	08951270	08961270	09951270	09961270
.551	14	4-1/2	1-3/8	.055		1951400	1961400	08951400	08961400	09951400	09961400
5/8		4-1/2	1-3/8	.063		1951587	1961587	08951587	08961587	09951587	09961587
.630	16	4-1/2	1-3/8	.063	1911600	1951600	1961600	08951600	08961600	09951600	09961600
.709	18	5-1/8	1-5/8	.071		1951800	1961800	08951800	08961800	09951800	09961800
3/4		5-1/8	1-5/8	.075		1951905	1961905	08951905	08961905	09951905	09961905
.787	20	5-1/8	1-5/8	.079	1912000	1952000	1962000	08952000	08962000	09952000	09962000
.984	25	5-3/8	1-3/4	.098		1952500	1962500	08952500	08962500	09952500	09962500
1		5-3/8	1-3/4	.100		1952540	1962540	08952540	08962540	09952540	09962540

*FUTURA coating (TiAlN) is also available at same pricing as Red'X in 90° and 120° by designating 0995xxxxF

Example: 09950635 = Red'X Coating 09950635F = Futura Coating

Tolerances

Diameters	Tolerance D	Angle	L
.078 - .118	0 + .0002"		
1/8 - .236	0 + .0003"	± 1°	± .0395
1/4 - .394	0 + .0004"		
.472 - 1	0 + .0005"		

COBALT SPOT DRILL
Value SETS
American Standard
 4 PIECES

COMPOSITION 1/4 - 3/8 - 1/2 - 5/8 - Ø

TYPE	Cobalt	
90°	Code	S195/4
120°	Code	S196/4

Sets also available TiN and Futura coated



NC SPOTTING DRILLS

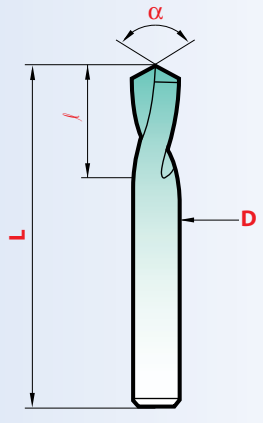

Long series

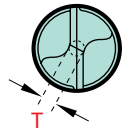
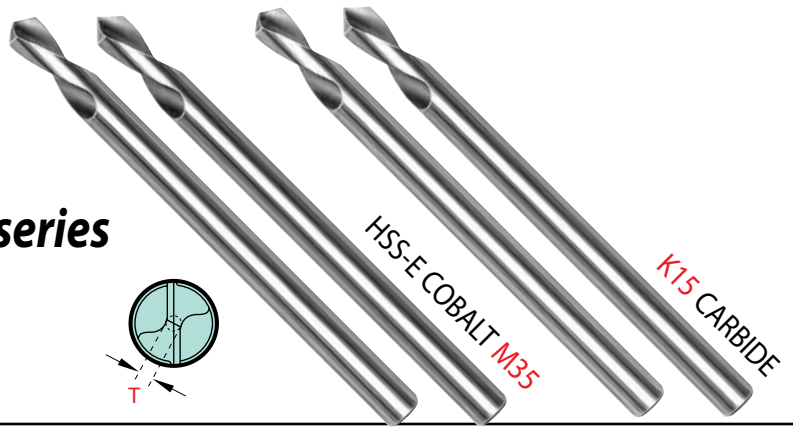

Angle					90°	120°	90°	120°
Diameter		L	ℓ	T	Cobalt	Cobalt	Carbide	Carbide
inch	mm				197	199	8197	8199
.118	3	3-1/8	.400	.012	1970300	1990300		
.157	4	4	.475	.016	1970400	1990400	81970400	81990400
.197	5	4-3/4	.600	.020	1970500	1990500	81970500	81990500
.236	6	5-1/2	.800	.023	1970600	1990600	81970600	81990600
1/4		5-1/2	.870	.025	1970635	1990635	81970635	81990635
.315	8	5-1/2	1	.031	1970800	1990800	81970800	81990800
3/8		6-3/4	1	.039	1970952	1990952	81970952	81990952
.394	10	6-3/4	1	.039	1971000	1991000	81971000	81991000
.472	12	6-3/4	1-3/16	.047	1971200	1991200	81971200	81991200
1/2		6-3/4	1-3/8	.051	1971270	1991270	81971270	81991270
5/8		8	1-3/8	.063	1971587	1991587	81971587	81991587
.630	16	8	1-3/8	.063	1971600	1991600	81971600	81991600
3/4		8	1-5/8	.075	1971905	1991905	81971905	81991950
.787	20	8	1-5/8	.079	1972000	1992000	81972000	81992000
1		8	1-3/4	.100	1972540	1992540		

K15 CARBIDE — 6.5 - 7% Cobalt (0,006 - 0,008mm grain size)

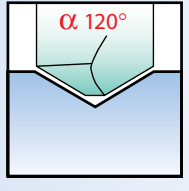

120 and 140 degree angles:
The preliminary hole obtained with the **magafor NC drill** corresponds to the angle at the end of the tool used in drilling and prevents it from deviating.

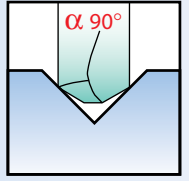

90 degree angle:
By using the **magafor NC drill** of diameter over the drilling tool, centering and chamfering are obtained in a single operation.

DUO-MAG = 2 Single End NC Spot Drills

New 2010!

Tolerance in inches

Diameters	Tolerance D	Angle	L
.078 - .118	0 + .0002"	± 1°	± .0395
1/8 - .236	0 + .0003"		
1/4 - .394	0 + .0004"		
.472 - 1	0 + .0005"		

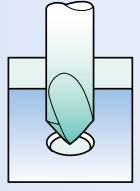
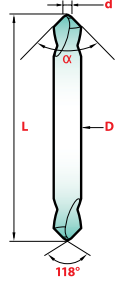

Chamfering

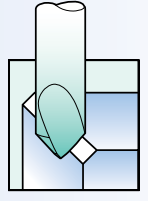

Longitudinal Chamfering

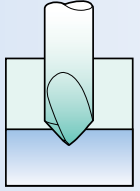

Centering Spotting

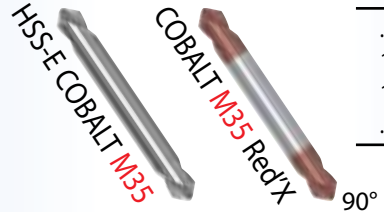

DUO-MAG Double End NC Spot Drills

D x d	L	Duo-Mag 019	Red'X 0919
3,0 x 0,5	40	019030500	091903050
4,0 x 1,0	45	019041000	091904100
6,0 x 2,0	55	019062000	091906200
8,0 x 2,5	65	019082500	091908250
10,0 x 3,0	75	019103000	091910300
12,0 x 3,5	85	019123500	091912350
16,0 x 4,0	90	019164000	091916400
20,0 x 5,0	100	019205000	091920500

DUO-MAG Long Double End NC Spot Drills

D x d	L	Duo-Mag 019	Red'X 0919
3,0 x 0,5	100	019L03050	0919L3050
4,0 x 1,0	100	019L04100	0919L0410
6,0 x 2,0	100	019L06200	0919L0620
8,0 x 2,5	100	019L08250	0919L0825
10,0 x 3,0	100	019L10300	0919L1030
12,0 x 3,5	100	019L12350	0919L1235
16,0 x 4,0	150	019XL1640	0919XL164
20,0 x 5,0	150	019XL2050	0919XL205

1 MULTI-V® = 10 OPERATIONS

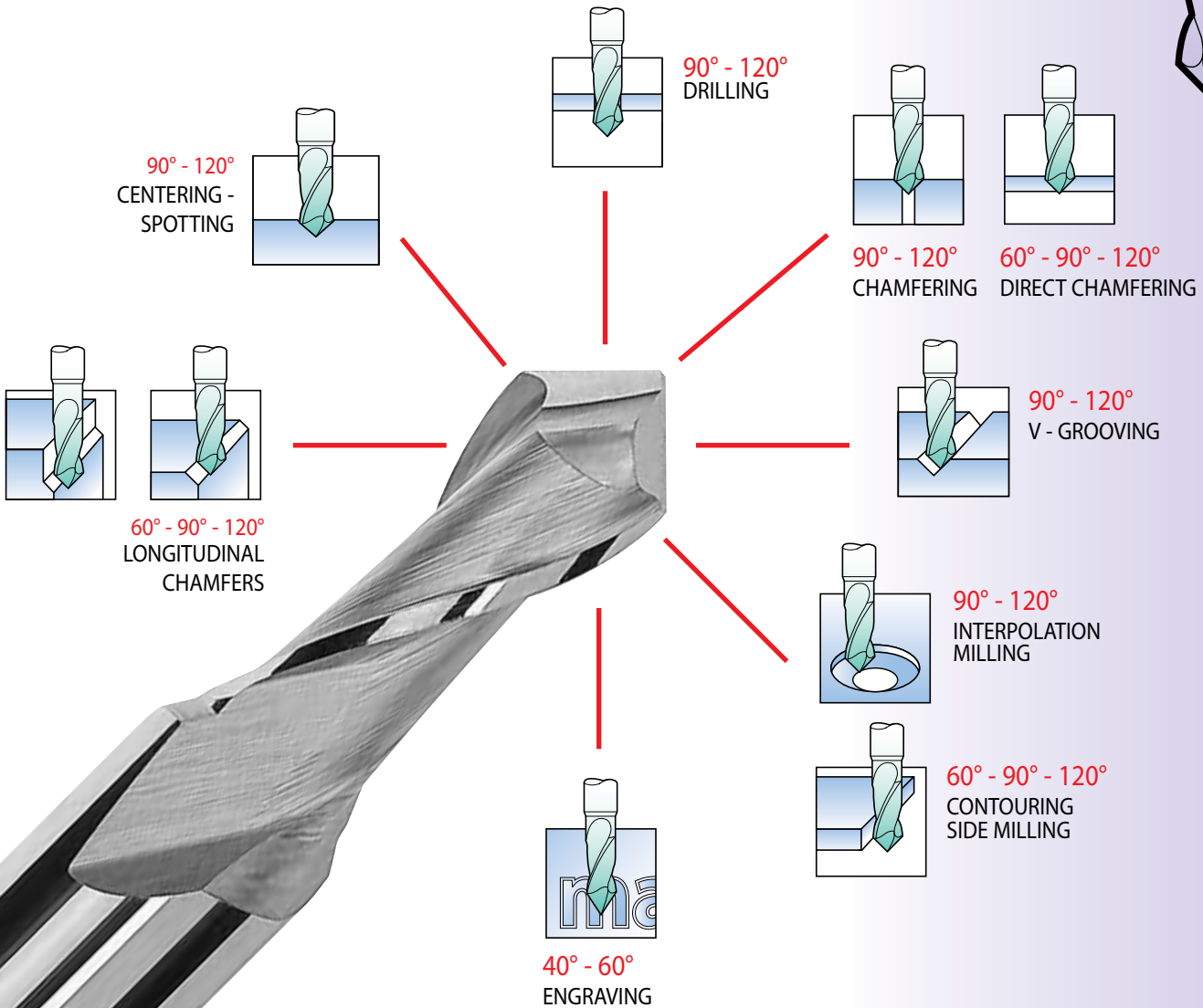

MULTI-FUNCTION TOOLS

This is the ideal tool for machine centers and NC processing machines.

- Combination of multiple machining process:
 - reduction in machine set-up time.
 - reduction of operating time.
 - less overall tool changes.
- Improved performances:
 - fine cutting edge with improved depth and surface finish.
 - micrograin solid carbide for better wear resistance and greater rigidity.
 - 30° spiral helix facilitates better chip removal.
- Easy storage:
 - fewer tools required.
 - less tool spaces required in magazine.

MULTI-V® 10 OPERATIONS

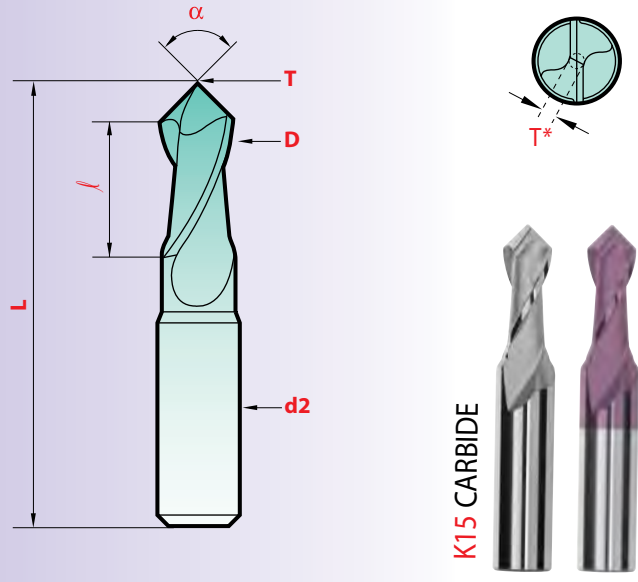

T = 0.1 D : Web thickness

Diameters	α	d2
.020 - .118 -0 - .0010	.118	0 - .00020
.157 - .236 -0 - .0012	.157 - .197	0 - .00030
.250 - .394 -0 - .0014	±1° .197 - .500	0 - .00035
.472 - .630 -.0018 - .0036	.500 - .630	0 - .00045
.787 -.0025 - .0045	.787	0 - .00050

Tolerances

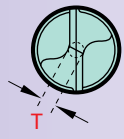

METRIC

STANDARD magafor

Angle						40°	60°	120°	
Diameter inch mm	L	l	d2	T*	MULTI-V 8040†	MULTI-V 8088†	Hard'X 8088-H†	MULTI-V 8092	Hard'X 8092-H
.020 0,5	1-1/2	.040	.118	.002	8040005	8088005	8088005-H		
.039 1,0	1-1/2	.080	.118	.004		8088010	8088010-H	8092010	8092010-H
.059 1,5	1-1/2	.120	.118	.006		8088015	8088015-H	8092015	8092015-H
.078 2,0	1-1/2	.160	.118	.008		8088020	8088020-H	8092020	8092020-H
.098 2,5	1-1/2	.195	.118	.010		8088025	8088025-H	8092025	8092025-H
.118 3	2	.240	.157	.012		8088030	8088030-H	8092030	8092030-H
.157 4	2	.315	.197	.016		8088040	8088040-H	8092040	8092040-H
.197 5	2	.395	.236	.020		8088050	8088050-H	8092050	8092050-H
.236 6	2-3/8	.475	.315	.023		8088060	8088060-H	8092060	8092060-H
.315 8	2-3/4	.630	.394	.031		8088080	8088080-H	8092080	8092080-H
.394 10	2-3/4	.710	.472	.039		8088100	8088100-H	8092100	8092100-H
.472 12	2-3/4	.790	.472	.047		8088120	8088120-H	8092120	8092120-H
.630 16	3-1/8	1.025	.630	.063		8088160	8088160-H	8092160	8092160-H
.787 20	4	1.260	.787	.079		8088200	8088200-H	8092200	8092200-H

T* = web thickness of split point

† Angle 40° - 60° : ideal for engraving

STANDARD magafor Angle 90°

Diameter inch mm	L	l	d2	T*	MULTI-V 8090	Hard'X 8090-H
.020 0,5	1-1/2	.040	.118	.002	80900050	80900050-H
.024 0,6	1-1/2	.047	.118	.002	80900060	80900060-H
.028 0,7	1-1/2	.055	.118	.003	80900070	80900070-H
.031 0,8	1-1/2	.063	.118	.003	80900080	80900080-H
.035 0,9	1-1/2	.071	.118	.003	80900090	80900090-H
.039 1,0	1-1/2	.080	.118	.004	80900100	80900100-H
.047 1,2	1-1/2	.095	.118	.005	80900120	80900120-H
.055 1,4	1-1/2	.110	.118	.006	80900140	80900140-H
.059 1,5	1-1/2	.120	.118	.006	80900150	80900150-H
.063 1,6	1-1/2	.125	.118	.006	80900160	80900160-H
.071 1,8	1-1/2	.140	.118	.007	80900180	80900180-H
.078 2,0	1-1/2	.160	.118	.008	80900200	80900200-H
.098 2,5	1-1/2	.195	.118	.010	80900250	80900250-H
.118 3	2	.240	.157	.012	80900300	80900300-H
.157 4	2	.315	.197	.016	80900400	80900400-H
3/16	2	.375	1/4	.020	80900476	80900476-H
.197 5	2	.395	.236	.020	80900500	80900500-H
.236 6	2-3/8	.475	.315	.023	80900600	80900600-H
1/4	2-3/8	.475	5/16	.025	80900635	80900635-H
5/16	2-3/4	.630	3/8	.031	80900793	80900793-H
.315 8	2-3/4	.630	.394	.031	80900800	80900800-H
3/8	2-3/4	.710	1/2	.039	80900952	80900952-H
.394 10	2-3/4	.710	.472	.039	80901000	80901000-H
.472 12	2-3/4	.790	.472	.047	80901200	80901200-H
1/2	2-3/4	.790	1/2	.051	80901270	80901270-H
5/8	3-1/8	1.000	5/8	.063	80901587	80901587-H
.630 16	3-1/8	1.025	.630	.063	80901600	80901600-H
.787 20	4	1.260	.787	.079	80902000	80902000-H

T* = web thickness of split point

K15 CARBIDE — 6.5 - 7% Cobalt (0,006 - 0,008mm grain size)

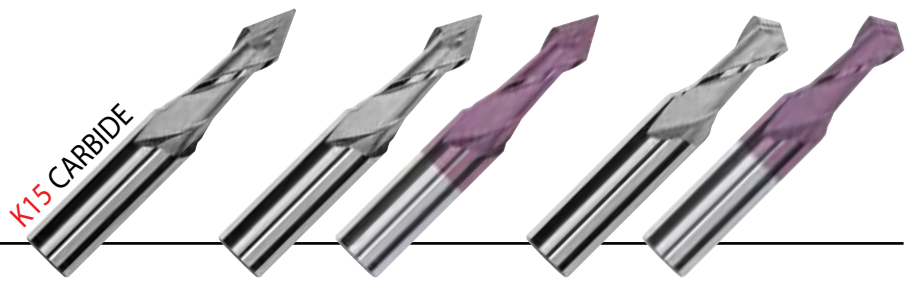

MULTI-V : RECOMMENDATIONS OF USING

MATERIAL	SPEED SFM	diameter		FEED inches/rev.				
				3mm-3/16"	5mm-1/4"	10mm-5/16"	12mm-1/2"	16mm-5/8"
Steel < 81 HRB (B)	230-247	RPM	6400	4000	2500	1900	1500	1300
		IPM	12.6	12.6	13.8	14.2	14.2	14.3
		inch/tooth	.002	.0031	.0055	.0075	.0094	.0110
Steel < 24 Rc (C)	132-197	RPM	4000	2600	1600	1200	900	850
		IPM	7.9	8.2	8.8	9.4	8.9	9.4
		inch/tooth	.002	.0031	.0055	.0075	.0094	.0110
Steels 24-32 Rc Cast Iron ≤ 180 HB (Grey Cast Iron)	115-132	RPM	3200	2200	1400	1000	850	680
		IPM	5.7	6.1	6.6	7.1	7.4	7.5
		inch/tooth	.0018	.0028	.0047	.0071	.0087	.0110
Steels 32-41 Rc Cast Iron > 180 HB Stainless Steels	99-115	RPM	2800	1800	1100	800	650	550
		IPM	5.0	5.0	5.2	5.4	5.6	5.6
		inch/tooth	.0018	.0028	.0047	.0067	.0087	.0102
Titanium Alloys	82-99	RPM	2200	1600	900	660	500	480
		IPM	3.5	3.8	3.9	4.1	4.3	4.7
		inch/tooth	.0016	.0024	.0043	.0063	.0087	.0098
Ni Co Alloys Inconel-Nimonic-Waspaloy	66	RPM	1800	1100	700	500	400	320
		IPM	2.8	2.6	3.0	3.1	3.1	3.1
		inch/tooth	.0016	.0024	.0043	.0063	.0079	.0098
Copper alloys Bronze	165-395	RPM	5000	3500	2200	1900	1700	1400
		IPM	19.7	20.7	21.7	22.4	23.4	24.8
		inch/tooth	.0039	.0059	.0098	.0118	.0138	.0177
Aluminum	494	RPM	10000	6300	4000	3200	2500	2000
		IPM	19.7	22.3	23.6	25.2	26.6	27.6
		inch/tooth	.0020	.0035	.0059	.0079	.0106	.0138
Thermoplastics	494	RPM	7300	4600	2800	2900	2300	1900
		IPM	14.4	16.3	20.9	22.8	24.4	26.2
		inch/tooth	.002	.0035	.0075	.0079	.0106	.0138

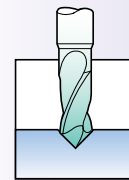

90°-120°
CENTERING - SPOTTING

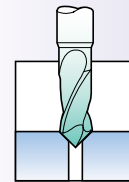

60°-90°-120°
CHAMFERING
DIRECT CHAMFERING

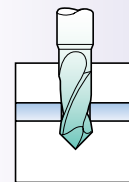

90°-120°
DRILLING

MATERIAL	SPEED SFM	diameter		FEED inches/rev.				
				3mm-3/16"	5mm-1/4"	10mm-5/16"	12mm-1/2"	16mm-5/8"
Steel < 81 HRB (B)	230-247	RPM	6800	4300	2650	2000	1500	1200
		IPM	2.6	2.6	2.8	3.0	3.0	3.0
		inch/tooth	.0002	.0003	.0006	.0007	.0010	.0012
Steel < 24 Rc (C)	132-197	RPM	5400	3500	2100	1600	1200	1000
		IPM	2.2	2.2	2.3	2.4	2.4	2.4
		inch/tooth	.0002	.0003	.0006	.0007	.0010	.0012
Steels 24-32 Rc Cast Iron ≤ 180 HB (Grey Cast Iron)	115-132	RPM	3600	2300	1400	1000	800	630
		IPM	1.1	1.1	1.3	1.4	1.4	1.4
		inch/tooth	.0002	.0002	.0005	.0007	.0008	.0011
Steels 32-41 Rc Cast Iron > 180 HB Stainless Steels	99-115	RPM	3000	2000	1200	900	700	550
		IPM	1.0	1.0	1.2	1.2	1.2	1.2
		inch/tooth	.0002	.0002	.0005	.0006	.0008	.0011
Titanium Alloys	82-99	RPM	2200	1600	1000	760	600	400
		IPM	0.7	0.8	0.8	0.8	0.9	0.9
		inch/tooth	.0002	.0002	.0004	.0005	.0007	.0011
Ni Co Alloys Inconel-Nimonic-Waspaloy	66	RPM	1800	1100	700	500	400	320
		IPM	0.4	0.5	0.6	0.6	0.6	0.6
		inch/tooth	.0001	.0002	.0004	.0005	.0007	.0010
Copper alloys Bronze	165-395	RPM	7000	6000	3500	3200	2200	1750
		IPM	4.4	4.7	4.7	5.0	5.2	5.5
		inch/tooth	.0003	.0004	.0007	.0008	.0012	.0016
Aluminum	494	RPM	13000	8600	5300	4000	3000	2400
		IPM	7.9	8.7	9.4	9.4	9.8	9.8
		inch/tooth	.0003	.0005	.0009	.0012	.0017	.0020
Thermoplastics	494	RPM	13000	8600	5300	4000	3000	2400
		IPM	10.2	10.2	10.4	10.6	10.6	10.6
		inch/tooth	.0004	.0006	.0010	.0013	.0018	.0022

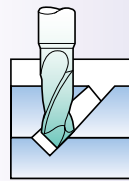

90°-120°
V - GROOVING

MATERIAL	SPEED SFM	diameter		FEED inches/rev.				
				3mm-3/16"	5mm-1/4"	10mm-5/16"	12mm-1/2"	16mm-5/8"
Steel < 81 HRB (B)	230-247	RPM	6800	4300	2650	2000	1500	1200
		IPM	4.3	4.7	5.1	5.9	6.1	6.1
		inch/tooth	.0003	.0006	.0010	.0016	.0020	.0026
Steel < 24 Rc (C)	132-197	RPM	5400	3500	2100	1600	1200	1000
		IPM	3.3	3.5	4.1	4.7	4.9	4.9
		inch/tooth	.0003	.0005	.0010	.0016	.0020	.0024
Steels < 24-32 Rc Cast Iron ≤ 180 HB (Grey Cast Iron)	115-132	RPM	3600	2300	1400	1000	800	630
		IPM	2.3	2.4	2.8	3.1	3.1	3.1
		inch/tooth	.0003	.0005	.0010	.0016	.0020	.0024
Steels 32-41 Rc Cast Iron > 180 HB Stainless Steels	99-115	RPM	3000	2000	1200	900	700	550
		IPM	1.8	2.0	2.4	2.6	2.6	2.6
		inch/tooth	.0003	.0005	.0010	.0014	.0020	.0024
Titanium Alloys	82-99	RPM	2200	1600	1000	760	600	400
		IPM	1.4	1.6	2.0	2.2	2.2	2.2
		inch/tooth	.0003	.0005	.0010	.0014	.0018	.0028
Ni Co Alloys Inconel-Nimonic-Waspaloy	66	RPM	1800	1100	700	500	400	320
		IPM	1.0	1.0	1.4	1.4	1.6	1.6
		inch/tooth	.0003	.0004	.0010	.0014	.0020	.0024
Copper alloys Bronze	165-395	RPM	10000	7000	3600	2500	2300	1800
		IPM	7.9	8.3	8.5	8.9	9.1	9.2
		inch/tooth	.0004	.0006	.0012	.0018	.0020	.0026
Aluminum	494	RPM	13000	8600	5300	4000	3000	2400
		IPM	8.3	8.9	12.6	14.2	11.8	12.2
		inch/tooth	.0003	.0005	.0012	.0018	.0020	.0026
Thermoplastics	494	RPM	13000	8600	5300	4000	3000	2400
		IPM	12.2	10.2	14.6	15.7	12.6	13.0
		inch/tooth	.0005	.0006	.0014	.0020	.0020	.0028

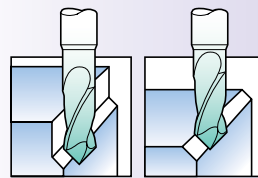

60°-90°-120°
LONGITUDINAL
CHAMFERS

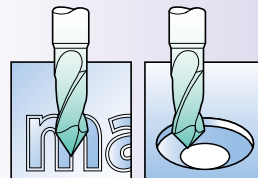

90°-120°
INTERPOLATION
MILLING



40°-60°
ENGRAVING

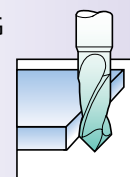

60°-90°-120°
CONTOURING
SIDE MILLING

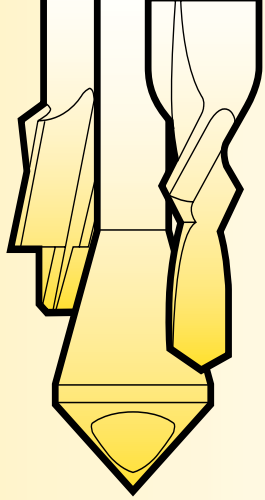

COUNTERSINKS

ZERO FLUTE WITH HOLE

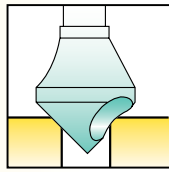

Range Ø 15 = 6 - 14 mm
Range Ø 25 = 8 - 21 mm

		Angle				
		60°	82°	90°	100°	120°
	Page	Page	Page	Page	Page	Page
	21	21	21	21	21	21

ADVANTAGES:

- For light metals and plastics
- For deburring and small chamfers
- Best surface finish
- Works without vibrations

SINGLE FLUTE

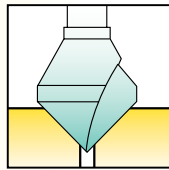

Range Ø 15 = 2 - 15 mm
Range Ø 25 = 3 - 25 mm

		Angle				
		60°	82°	90°	100°	120°
	Page	Page	Page	Page	Page	Page
	22	22	23	23	23	23

ADVANTAGES:

- For wood and hard plastics
- Can drill in sheet materials
- Easy to sharpen
- Works without vibrations

TRIDENT THREE FLUTES

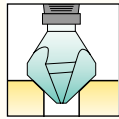
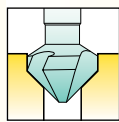

Range Ø 15 = 5 - 15 mm
Range Ø 25 = 6 - 25 mm

		Angle					
		30°	60°	82°	90°	100°	120°
	Page	Page	Page	Pages	Page	Page	Page
	26	26	26	24-25	26	26	26

ADVANTAGES:

- Self-centering (3 flutes)
- Designed for 82° capscrew countersinking
- Hand using
- Longitudinal chamfers and contouring
- Works without vibrations

Hand
Countersinks
Page 26

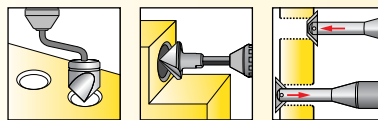

- Chamfering
- Deburring

BI-FACE CHAMFERING BICONICAL CUTTERS

NEW!

60° & 90°

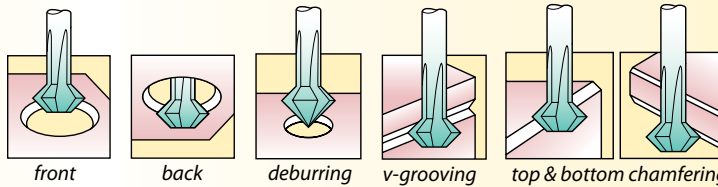

Page
27

AUTO BODY SPOT WELD DRILL BITS

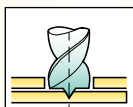

- Disconnect sheet metal spot weld

Page
28

ZERO FLUTE DEBURRING TOOL With Hole

Angle 90°		TYPE		Right hand		Left hand	
#	Diameter inch mm	Capacity min/max	d	L	Cobalt 411	M35/TIN 4811	Cobalt 416
0	1/4 ¹	5/64 - 3/16	1/4	1-3/4	4110635	48110635	
	.394 10	5/32 - 11/32	.236	1-3/4	4111000	48111000	4161000
1	7/16	7/32 - 13/32	1/4	1-3/4	4111120	48111120	
2	9/16	1/4 - 1/2	1/4	2	4111400	48111400	
	.590 15	1/4 - 9/16	.315	2-1/4	4111500	48111500	4161500
	.787 20	5/16 - 11/16	.394	2-1/2	4112000	48112000	4162000
	3	13/16	5/16 - 11/16	1/2	2-5/8	4112040	48112040
.984 25		3/8 - 7/8	.472	3	4112500	48112500	4162500
	1.102 28	7/16 - 1	.472	3-3/8	4112800	48112800	4162800
	1.181 30	1/2 - 1-1/8	.472	3-1/2	4113000	48113000	4163000
4	1-3/16	1/2 - 1-1/8	1/2	3-1/2	4113010	48113010	
	1.378 35	9/16 - 1-5/16	.630 ²	4	4113500	48113500	4163500
	1.575 40	5/8 - 1-1/2	.630 ²	4-5/8	4114000	48114000	4164000
	1.969 50	3/4 - 1-7/8	.630 ²	5	4115000	48115000	4165000

¹ Double end cutter

² Shanks with 3 flats for better holding

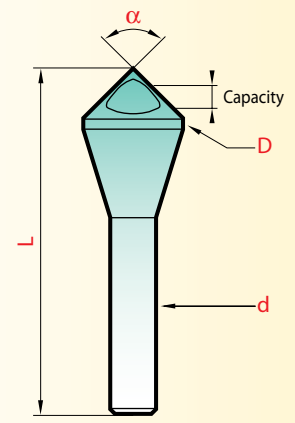
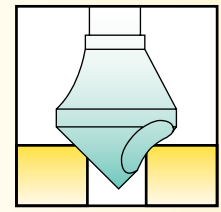

D	Angle	d	L
+0.3	-1°	h9	±1mm

Tolerances

The deburring tool "with hole" is more particularly designed for countersinking and chamfering light metals and plastics. The surface obtained is smooth and without burrs. We recommend lubricating.



SETS OF 5 ZERO FLUTE CUTTERS

Angle	magafor EDP#	COMPOSITION
60°	S412	Ø 10-15-20-25-30 mm
	S412/5	# 0-1-2-3-4
82°	S414	Ø 10-15-20-25-30 mm
	S414/5	# 0-1-2-3-4
90°	S411	Ø 10-15-20-25-30 mm
	S4811-TIN	Ø 10-15-20-25-30 mm
	S411/2	Ø 10-15-20-28-35 mm
	S411/5	# 0-1-2-3-4
100°	S4811/5-TIN	# 0-1-2-3-4
	S415	Ø 10-15-20-25-30 mm
120°	S413	Ø 10-15-20-25-30 mm

Angle	#	Diameter inch mm	Capacity min/max	d	L	Cobalt
60° 412	0	1/4 ¹	7/64 - 3/16	1/4	1-3/4	4120635
		.394 10	3/16 - 11/32	.236	2	4121000
	1	7/16	3/16 - 3/8	1/4	1-3/4	4121120
		9/16	9/32 - 1/2	1/4	2	4121400
		.590 15	5/16 - 9/16	.315	2-3/8	4121500
		.787 20	3/8 - 11/16	.394	2-7/8	4122000
	3	13/16	3/8 - 11/16	1/2	2-5/8	4122040
		.984 25	1/2 - 7/8	.472	3-3/8	4122500
	1.181 30	9/16 - 1-1/8	.472	3-5/8	4123000	
	1.378 35	1-1/8 - 1-5/8	.630 ²	4-1/2	4123500	
82° 414	0	1/4 ¹	5/64 - 3/16	1/4	1-3/4	4140635
		.394 10	5/32 - 11/32	.236	1-3/4	4141000
	1	7/16	7/32 - 13/32	1/4	1-3/4	4141120
		9/16	1/4 - 1/2	1/4	2	4141400
		.590 15	1/4 - 9/16	.315	2-1/4	4141500
		.787 20	5/16 - 11/16	.394	2-1/2	4142000
	3	13/16	5/16 - 11/16	1/2	2-5/8	4142040
		.984 25	3/8 - 7/8	.472	3	4142500
	1.181 30	1/2 - 1-1/8	.472	3-1/2	4143000	
	1.378 35	9/16 - 1-5/16	.630 ²	4	4143500	
100° 415		.394 10	5/32 - 11/32	.236	1-3/4	4151000
		.590 15	1/4 - 9/16	.315	2-1/8	4151500
		.787 20	9/32 - 11/16	.394	2-1/2	4152000
		.984 25	11/32 - 7/8	.472	3	4152500
	1.181 30	7/16 - 1-1/16	.472	3-3/8	4153000	
	1.378 35	1/2 - 1-5/16	.630 ²	4	4153500	
120° 413		.394 10	5/32 - 11/32	.236	1-3/4	4131000
		.590 15	1/4 - 9/16	.315	2	4131500
		.787 20	9/32 - 11/16	.394	2-3/8	4132000
		.984 25	11/32 - 7/8	.472	2-7/8	4132500
		1.181 30	7/16 - 1-1/16	.472	3-1/4	4133000
	1.378 35	1/2 - 1-5/16	.630 ²	3-3/4	4133500	

¹ Double end cutter

² 3 flatted shanks



Single flute CHAMFERING CUTTERS

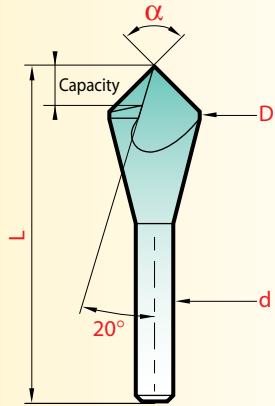
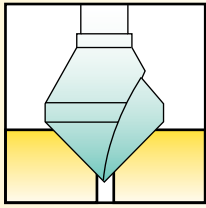

D	Angle	d	L
+0.3	-1°	h9	±1mm

Tolerances

The characteristics of the single flute chamfering cutters are similar to those of the deburring tools "with hole". They do vary on the following points :

- greater countersinking capacity, from the point to the outside diameter (up to Ø 30 mm),
- simultaneous drilling and countersinking on thin elements (laminates, aluminium, wood).

Constant finish-grind profile makes it possible to obtain many easy regrinds : a mere touch of the grinder to the tooth is sufficient. We recommend lubricating.

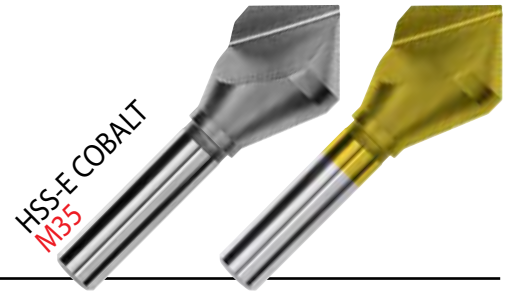

Angle	Diameter		Capacity min/max	d	L	Cobalt 422	M35/TIN 4822
	inch	mm					
60°	1/8		1/32 - 1/8	1/8	1-1/4	4220317	48220317
	3/16		3/64 - 3/16	3/16	1-3/8	4220476	48220476
	.236	6	3/64 - .236	.236	1-5/8	4220600	48220600
	1/4		3/64 - 1/4	1/4	1-1/2	4220635	48220635
	5/16		3/64 - 5/16	1/4	1-5/8	4220793	48220793
	3/8		3/64 - 3/8	1/4	1-3/4	4220952	48220952
	.394	10	3/64 - .394	.236	1-7/8	4221000	48221000
	.472	12	5/64 - .472	.315	2-1/8	4221200	48221200
	1/2		5/64 - 1/2	1/4	2	4221270	48221270
	.590	15	5/64 - .590	.315	2-3/8	4221500	48221500
	5/8		5/64 - 5/8	3/8	2-1/4	4221587	48221587
	3/4		5/64 - 3/4	1/2	2-5/8	4221905	48221905
	.787	20	5/64 - .787	.394	2-7/8	4222000	48222000
	7/8		7/64 - 7/8	1/2	2-3/4	4222222	48222222
	.984	25	1/8 - .984	.472	3-3/8	4222500	48222500
	1		1/8 - 1	1/2	2-3/4	4222540	48222540
1.181	30	1/8 - 1.181	.472	3-5/8	4223000	48223000	
1-1/4		1/8 - 1-1/4	1/2	3	4223175	48223175	

Angle	Diameter		Capacity min/max	d	L	Cobalt 424	M35/TIN 4824
	inch	mm					
82°	1/8		1/32 - 1/8	1/8	1-1/4	4240317	48240317
	3/16		3/64 - 3/16	3/16	1-3/8	4240476	48240476
	.236	6	3/64 - .236	.236	1-5/8	4240600	48240600
	1/4		3/64 - 1/4	1/4	1-1/2	4240635	48240635
	5/16		3/64 - 5/16	1/4	1-5/8	4240793	48240793
	3/8		3/64 - 3/8	1/4	1-3/4	4240952	48240952
	.394	10	3/64 - .394	.236	1-3/4	4241000	48241000
	.472	12	5/64 - .472	.315	2	4241200	48241200
	1/2		5/64 - 1/2	1/4	2	4241270	48241270
	.590	15	5/64 - .590	.315	2-1/4	4241500	48241500
	5/8		5/64 - 5/8	3/8	2-1/4	4241587	48241587
	3/4		5/64 - 3/4	1/2	2-5/8	4241905	48241905
	.787	20	5/64 - .787	.394	2-5/8	4242000	48242000
	7/8		7/64 - 7/8	1/2	2-3/4	4242222	48242222
	.984	25	1/8 - .984	.472	3	4242500	48242500
	1		1/8 - 1	1/2	2-3/4	4242540	48242540
1.181	30	1/8 - 1.181	.472	3-1/2	4243000	48243000	
1-1/4		1/8 - 1-1/4	1/2	2-3/4	4243175	48243175	

NOTE : 30 and 45 degree angles are metric standard. Call for information.

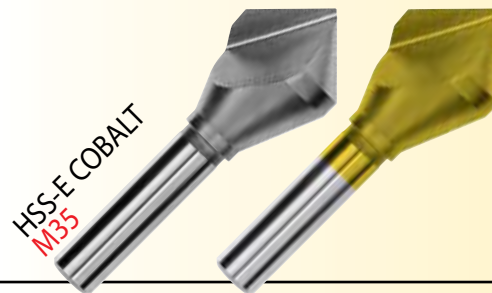
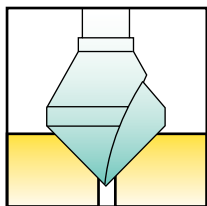

SETS OF 6 PIECE
SINGLE FLUTE
COUNTERSINKS

1/4 - 5/16 - 3/8 - 1/2 - 5/8 - 3/4

Angle	Cobalt	M35/TIN
60°	S422/6	4822/6
82°	S424/6	4824/6
90°	S421/6	4821/6



SETS OF 5 PIECES
SINGLE FLUTE
COUNTERSINKS

METRIC

10 - 15 - 20 - 25 - 30

Angle	Cobalt	M35/TIN
60°	S422	4822
82°	S424	4824
90°	S421	4821
100°	S425	4825
120°	S423	4823

Angle	Diameter		Capacity min/max	d	L	Cobalt 421	M35/TIN 4821
	inch	mm					
90°	1/8		1/32 - 1/8	1/8	1-1/4	4210317	48210317
	.157	4	3/64 - .157	.157	1-1/2	4210400	48210400
	3/16		3/64 - 3/16	3/16	1-3/8	4210476	48210476
	.197	5	3/64 - .197	.197	1-1/2	4210500	48210500
	.236	6	3/64 - .236	.236	1-1/2	4210600	48210600
	1/4		3/64 - 1/4	1/4	1-1/2	4210635	48210635
	5/16		3/64 - 5/16	1/4	1-5/8	4210793	48210793
	.315	8	3/64 - .315	.236	1-1/2	4210800	48210800
	3/8		3/64 - 3/8	1/4	1-3/4	4210952	48210952
	.394	10	3/64 - .394	.236	1-3/4	4211000	48211000
	.472	12	5/64 - .472	.315	2	4211200	48211200
	1/2		5/64 - 1/2	1/4	2	4211270	48211270
	.590	15	5/64 - .590	.315	2-1/8	4211500	48211500
	5/8		5/64 - 5/8	3/8	2-1/4	4211587	48211587
	3/4		5/64 - 3/4	1/2	2-5/8	4211905	48211905
	.787	20	5/64 - .787	.394	2-5/8	4212000	48212000
	7/8		7/64 - 7/8	1/2	2-3/4	4212222	48212222
	.984	25	1/8 - .984	.472	3	4212500	48212500
	1		1/8 - 1	1/2	2-3/4	4212540	48212540
	1.181	30	1/8 - 1.181	.472	3-1/2	4213000	48213000
1-1/4		1/8 - 1-1/4	1/2	2-3/4	4213175	48213175	
1.378	35	5/32 - 1.378	.630 ¹	4	4213500	48213500	
1.575	40	7/32 - 1.575	.630 ¹	4-5/8	4214000	48214000	
2	50	15/32 - 2	.630 ¹	5	4215000	48215000	

¹Shank with 3 flats for better holding

Angle	Diameter		Capacity min/max	d	L	Cobalt 425	M35/TIN 4825
	inch	mm					
100°	.394	10	3/64 - .394	.236	1-3/4	4251000	48251000
	.472	12	5/64 - .472	.315	1-7/8	4251200	48251200
	.590	15	5/64 - .590	.315	2-1/8	4251500	48251500
	.787	20	5/64 - .787	.394	2-1/2	4252000	48252000
	.984	25	1/8 - .984	.472	3	4252500	48252500
	1.181	30	1/8 - 1.181	.472	3-3/8	4253000	48253000

Angle	Diameter		Capacity min/max	d	L	Cobalt 423	M35/TIN 4823
	inch	mm					
120°	.394	10	3/64 - .394	.236	1-3/4	4231000	48231000
	.472	12	5/64 - .472	.315	1-7/8	4231200	48231200
	.590	15	5/64 - .590	.315	2	4231500	48231500
	.787	20	5/64 - .787	.394	2-3/8	4232000	48232000
	.984	25	1/8 - .984	.472	2-7/8	4232500	48232500
	1.181	30	1/8 - 1.181	.472	3-1/4	4233000	48233000

TRIDENT 90° Three flute COUNTERSINKS

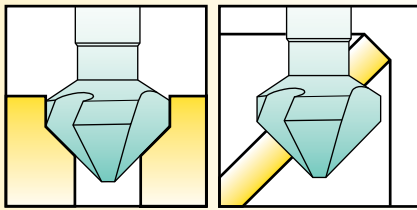
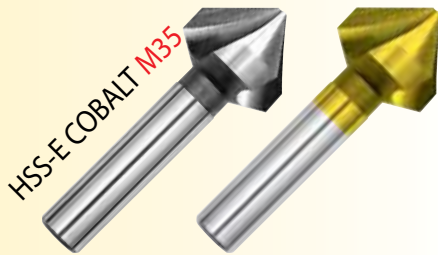

COUNTERSINK CHAMFER

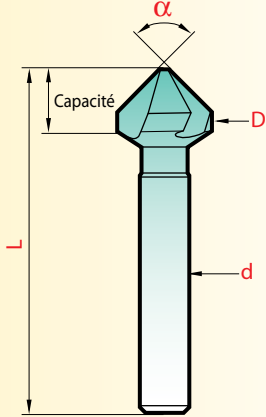

D	Angle	d	L
± 0.05	- 1°	h9	± 1mm

Tolerances

This highly productive countersinking cutter is a much improved version of the traditional multiflute milling cutter

- grooves opened wide to allow for greater chip removal,
- high positive cut,
- constant profile relief (a great many regrinds),
- self centering countersink,
- work without vibration.

Tool dimensions are adapted to countersink the 82° and 90° capscrews. Lubrication is recommended.

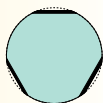

90° THREE FLUTE COUNTERSINKS

Angle 90°

Diameter inch	mm	Capacity min/max	d	L	Cobalt 431	M35/TIN 4831
.158	4,0	.051 - .158	.158	1-5/8	4310400	48310400
.170	4,3	.051 - .170	.158	1-5/8	4310430	48310430
.197	5,0	.051 - .197	.158	1-5/8	4310500	48310500
.209	5,3	.051 - .209	.197	1-3/4	4310530	48310530
.229	5,8	.051 - .229	.197	1-3/4	4310580	48310580
.236	6,0	.051 - .236	.197	1-3/4	4310600	48310600
.248	6,3	.051 - .248	.197	1-3/4	4310630	48310630
1/4	6,35	.050-.250	1/4	1-3/4	4310635	48310635
.276	7,0	.063 - .276	.236	2	4310700	48310700
.288	7,3	.063 - .288	.236	2	4310730	48310730
5/16	7,94	.070-.312	1/4	1-3/4	4310793	48310793
.315	8,0	.071 - .315	.236	2	4310800	48310800
.327	8,3	.071 - .327	.236	2	4310830	48310830
.354	9,0	.079 - .354	.236	2	4310900	48310900
.370	9,4	.079 - .370	.236	2	4310940	48310940
3/8	9,52	.085-.375	1/4	2	4310952	48310952
.394	10,0	.087 - .394	.236	2	4311000	48311000
.410	10,4	.087 - .410	.236	2	4311040	48311040
.453	11,5	.098 - .453	.315	2-1/4	4311150	48311150
.472	12,0	.098 - .472	.315	2-1/4	4311200	48311200
.488	12,4	.098 - .488	.315	2-1/4	4311240	48311240
1/2	12,70	.100-.500	1/4	2	4311270	48311270
.528	13,4	.098 - .528	.315	2-1/4	4311340	48311340
.567	14,4	.098 - .567	.315	2-1/4	4311440	48311440
.590	15,0	.110 - .590	.394	2-3/8	4311500	48311500
5/8	15,87	.110-.625	3/8	2-3/8	4311587	48311587
.650	16,5	.110 - .650	.394	2-3/8	4311650	48311650
.748	19,0	.118 - .748	.394	2-1/2	4311900	48311900
3/4	19,05	.120-.750	3/8	2-3/8	4311905	48311905
.807	20,5	.118 - .807	.394	2-1/2	4312050	48312050
.906	23,0	.126 - .906	.394	2-5/8	4312300	48312300
.984	25,0	.126 - .984	.394	2-5/8	4312500	48312500
1	25,40	.125-1.00	3/8	2-3/4	4312540	48312540
1.024	26,0	.126 - 1.024	.394	2-5/8	4312600	48312600
1.102	28,0	.138 - 1.102	.472	2-3/4	4312800	48312800
1.181	30,0	.138 - 1.181	.472	2-3/4	4313000	48313000
1.220	31,0	.138 - 1.220	.472	2-3/4	4313100	48313100

WITH 3 FLATTED SHANKS*

					Cobalt 437	TIN 4837
.488	12,4	.098 - .488	.315	2-1/4	437124	4837124
.567	14,4	.098 - .567	.315	2-1/4	437144	4837144
.650	16,5	.110 - .650	.394	2-3/8	437165	4837165
.807	20,5	.118 - .807	.394	2-1/2	437205	4837205
.984	25,0	.126 - .984	.394	2-5/8	437250	4837250
1.220	31,0	.138 - 1.220	.472	2-3/4	437310	4837310
1.339	34,0	.177 - 1.339	.630	4	437340	4837340
1.378	35,0	.177 - 1.378	.630	4	437350	4837350
1.457	37,0	.177 - 1.457	.630	4-5/8	437370	4837370
1.575	40,0	.177 - 1.575	.630	4-5/8	437400	4837400
1.969	50,0	.197 - 1.969	.630	5	437500	4837500
2.480	63,0	.394 - 2.480	.630	5-1/2	437630	4837630
3.150	80,0	.551 - 3.150	.630	6-1/2	437800	4837800

* Effective holding thanks to the three flats on shank

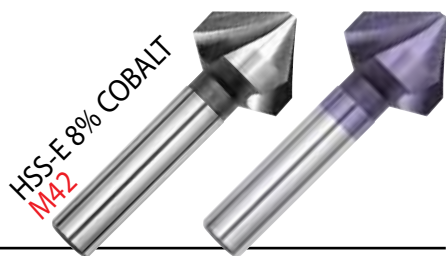

METRIC		Angle 90°				
Diameter inch mm	Capacity min/max	d	L	Cobalt + 436	M42/Futura 4936	
.248 6,3	.051 - .248	.197	1-3/4	436063	4936063	
.327 8,3	.071 - .327	.236	1-3/4	436083	4936083	
.410 10,4	.087 - .410	.236	1-3/4	436104	4936104	
.488 12,4	.098 - .488	.315	2-1/4	436124	3936124	
.650 16,5	.110 - .650	.394	2-3/8	436165	4936165	
.807 20,5	.118 - .807	.394	2-1/2	436205	4936205	
.984 25,0	.126 - .984	.394	2-5/8	436250	4936250	
1.220 31,0	.138 - 1.220	.472	2-3/4	436310	4936310	
1.969 50,0*	.197 - 1.969	.630	5	436500	4936500	

*3 flatted shanks

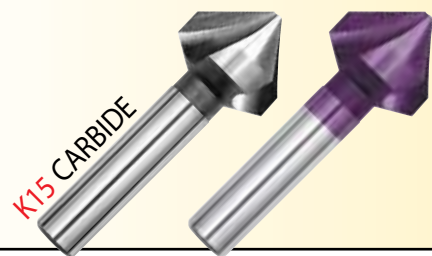

METRIC		Angle 90°				
Diameter inch mm	Capacity min/max	d	L	Carbide 8431	K15/Hard'X 8431-H	
.170 4,3	.051 - .170	.157	1-9/16	8431043	8431043-H†	
.209 5,3	.051 - .209	.157	1-9/16	8431053	8431053-H†	
.248 6,3	.051 - .248	.197	1-3/4	8431063	8431063-H†	
.327 8,3	.071 - .327	.236	1-3/4	8431083	8431083-H†	
.410 10,4	.087 - .410	.236	1-3/4	8431104	8431104-H	
.488 12,4*	.098 - .488	.315	2-1/4	8431124	8431124-H	
.650 16,5*	.110 - .650	.394	2-3/8	8431165	8431165-H	
.807 20,5*	.118 - .807	.394	2-1/2	8431205	8431205-H	
.984 25,0*	.126 - .984	.394	2-5/8	8431250	8431250-H	
1.220 31,0*	.138 - 1.220	.472	2-3/4	8431310	8431310-H	

* Ø 12,4 - 31,0 = 3 flatted shanks

† Ø 4,3 - 8,3 = Full solid carbide

Ø 10,4 - 31,0 = Brazed carbide head



3 FLUTE COUNTERSINK SETS ANGLE 90°

magafor	Diameter/COMPOSITION
S431	
S4831 TIN	10,4 - 16,5 - 20,5 - 25,0 - 31,0 mm
S436	
S431/2	
S4831/2 TIN	6,3 - 8,3 - 10,4 - 12,4 - 16,5 - 20,5 mm
S436/2	
S8431/2	
S431/3 ¹	6,3 - 8,3 - 10,4 - 12,4 - 16,5 - 20,5 - 25 mm
S431/4 ¹	4,3 - 5,3 - 6,3 - 8,3 - 10,4 - 12,4 - 16,5 - 20,5 - 25 - 31
S8431	10,4 - 16,5 - 20,5 - 25 - 31 mm carbide
S8443 ²	
S8448 TIN ²	6,3 - 12,4 - 16,5 - 20,5 mm
S431-M	
S431-M-TIN	10 - 15 - 20,5 mm

¹ Set supplied with 1 auto-lock chuck Code 4001.

² Set supplied with 8mm auto-lock chuck handle Code 4002.

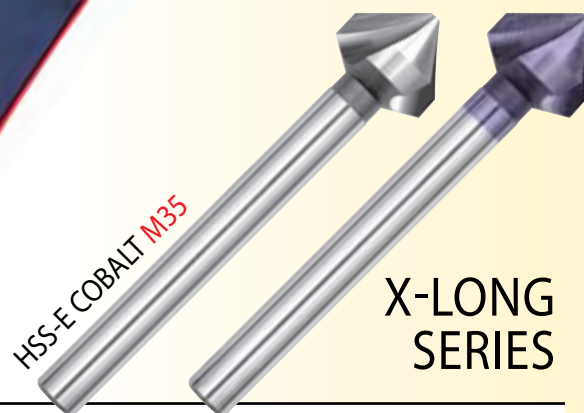

METRIC		Angle 90°				
Diameter inch mm	Capacity min/max	d	L	Cobalt 4303	M35/Futura 4933	
.248 6,3	.051 - .248	.236	3-5/16	4303063	4933063	
.327 8,3	.071 - .327	.315	3-3/8	4303083	4933083	
.410 10,4	.087 - .410	.394	3-1/2	4303104	4933104	
.488 12,4	.098 - .488	.394	4-1/4	4303124	4933124	
.650 16,5	.110 - .650	.630	4-7/16	4303165	4933165	
.807 20,5	.118 - .807	.630	4-1/2	4303205	4933205	
.984 25,0	.126 - .984	.788	4-11/16	4303250	4933250	

NOTE :

all these metric sizes are available within 2 weeks.
Call for information.

TRIDENT Three flute COUNTERSINKS

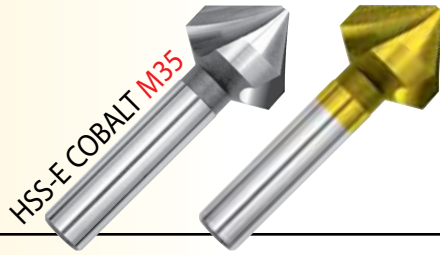

METRIC

Angle	Diameter inch mm	Capacity min/max	d	L	Cobalt	Angle	M35/TIN
30° 439	.248 6,3	.079 - .248	.197	2	4390630	30° 4839	48390630
	.488 12,4	.012 - .488	.315	2-1/2	4391240		48391240
	.650 16,5	.157 - .650	.394	3	4391650		48391650
	.984 25,0	.236 - .984	.394	3-1/2	4392500		48392500
60° 432	.248 6,3	.051 - .248	.197	1-7/8	4320630	60° 4832	48320630
	.327 8,3	.071 - .327	.236	2	4320830		48320830
	.410 10,4	.091 - .410	.236	2	4321040		48321040
	.488 12,4	.098 - .488	.315	2-3/8	4321240		48321240
	.650 16,5	.110 - .650	.394	2-1/2	4321650		48321650
	.807 20,5	.118 - .807	.394	2-3/4	4322050		48322050
	.984 25,0	.126 - .984	.394	3	4322500		48322500
1.22 31,0	.138 - 1.22	.472	3-1/8	4323100	48323100		
82° 434	.248 6,3	.051 - .248	.197	1-3/4	4340630	82° 4834	48340630
	1/4 6,35	.050 - .250	1/4	1-3/4	4340635		48340635
	5/16 7,94	.070 - .312	1/4	1-3/4	4340793		48340793
	.327 8,3	.070 - .327	.236	2	4340830		48340830
	3/8 9,52	.085 - .375	1/4	2	4340952		48340952
	.410 10,4	.087 - .410	.236	2	4341040		48341040
	.488 12,4	.098 - .488	.315	2-1/4	4341240		48341240
	1/2 12,7	.100 - .500	1/4	2	4341270		48341270
	5/8 15,87	.110 - .625	3/8	2-3/8	4341587		48341587
	.650 16,5	.110 - .650	.394	2.3/8	4341650		48341650
	3/4 19,05	.120 - .750	3/8	2-3/8	4341905		48341905
	.807 20,5	.118 - .807	.394	2-1/2	4342050		48342050
.984 25,0	.126 - .984	.394	2-11/16	4342500	48342500		
1.00 25,4	.125 - 1.00	3/8	2-3/4	4342540	48342540		
1.22 31,0	.138 - 1.22	.472	2-7/8	4343100	48343100		
100° 435	.248 6,3	.051 - .248	.197	1-3/4	4350630	100° 4835	48350630
	.327 8,3	.070 - .327	.236	2	4350830		48350830
	.410 10,4	.087 - .410	.236	2	4351040		48351040
	.488 12,4	.098 - .488	.315	2-3/16	4351240		48351240
	.650 16,5	.110 - .650	.394	2-5/16	4351650		48351650
	.807 20,5	.118 - .807	.394	2-7/16	4352050		48352050
	.984 25,0	.126 - .984	.394	2-1/2	4352500		48352500
1.22 31,0	.138 - 1.22	.472	2-11/16	4353100	48353100		
120° 433	.248 6,3	.051 - .248	.197	1-3/4	4330630	120° 4833	48330630
	.327 8,3	.070 - .327	.236	2	4330830		48330830
	.410 10,4	.087 - .410	.236	2	4331040		48331040
	.488 12,4	.098 - .488	.315	2-1/8	4331240		48331240
	.650 16,5	.110 - .650	.394	2-1/4	4331650		48331650
	.807 20,5	.118 - .807	.394	2-5/16	4332050		48332050
	.984 25,0	.126 - .984	.394	2-1/2	4332500		48332500
	1.22 31,0	.138 - 1.22	.472	2-1/2	4333100		48333100

TRIDENT HAND COUNTERSINKS



METRIC

Angle	82°	90°	
Diameter inch mm	Capacity min/max	Cobalt 438	Cobalt 430
.488 12,4	.118 - .488	4381240	4301240
.650 16,5	.157 - .650	4381650	4301650
.807 20,5	.157 - .807	4382050	4302050
.984 25,0	.197 - .984	4382500	4302500
1.220 31,0	.197 - 1.220	4383100	4303100

UNIVERSAL AUTO-LOCK CHUCK



Ergonomic Handle Capacity 3/64 - 8 mm	magafor 4002
Large Handle Capacity 3/64 - 1/2	magafor 4001

To hold any straight shank tool, for use by hand.



3 FLUTE COUNTERSINK SETS

Angle	Cobalt	COMPOSITION / mm
60°	S432	Ø 10,4 - 16,5 - 20,5 - 25 - 31
	S4832 TIN	
82°	S434	
	S4834-TIN	
100°	S435	
120°	S433	

New 2010!

BI-FACE ADVANTAGES

Special design = positive cut + relieving profile

- Unequalled surface finish
- Impressive performance
- Extended tools profile life

Tolerances

D	tolerance	L	α
∅ .040~.197	0 - .002	± .040	± 1°
∅ .236~.630	0 - .004	± .040	± 1°

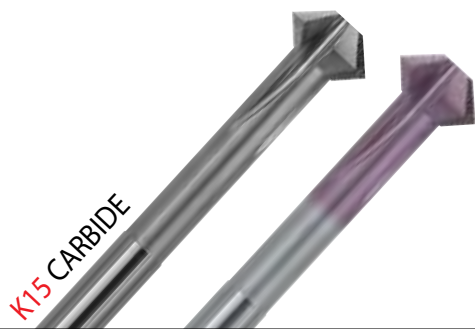

Angle 90° MINI 3 FLUTES

Diameter	d3	T	L	Bi-face	Hard'X
inch mm d2 max max min l2 l3	8480	8480-H			
.040 1,0 .118 .028 .012 2-3/8 .020 .197	8480010	8480H010			
.059 1,5 .118 .043 .018 2-3/8 .029 .236	8480015	8480H015			
.079 2,0 .118 .059 .024 2-3/8 .037 .315	8480020	8480H020			
.118 3,0 .118 .087 .035 2-3/8 .059 .394	8480030	8480H030			

Angle 90° STANDARD 4 FLUTES

Diameter	d3	T	L	Bi-face	Hard'X
inch mm d2 max max min l2 l3	8490	8490-H			
.118 3,0 .236 .087 .047 4 .051 .394	8490030	8490H030			
.157 4,0 .236 .114 .063 4 .069 .472	8490040	8490H040			
.197 5,0 .236 .134 .079 4 .091 .591	8490050	8490H050			
.236 6,0 .236 .154 .094 4 .114 .709	8490060	8490H060			
.315 8,0 .236 .193 .193 4 .118 1.339	8490080	8490H080			
.394 10,0 .236 .232 .232 4 .157 1.339	8490100	8490H100			
.472 12,0 .236 .232 .232 4 .236 1.339	8490120	8490H120			
.630 16,0 .394 .311 .311 4 .315 1.339	8490160	8490H160			

Angle 60° STANDARD 4 FLUTES

Diameter	d3	T	L	Bi-face	Hard'X
inch mm d2 max max min l2 l3	8460	8460-H			
.197 5,0 .236 .134 .134 4 .110 1.339	8460050	8460H050			
.315 8,0 .236 .193 .232 4 .213 1.339	8460080	8460H080			
.472 12,0 .394 .232 .232 4 .417 1.339	8460120	8460H120			

Bi-face

FRONT AND BACK CHAMFERING BICONICAL CUTTERS

COUNTERSINKING

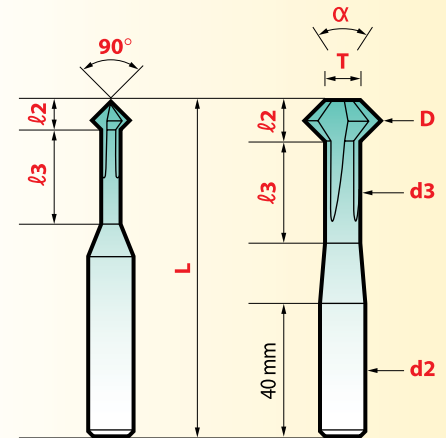
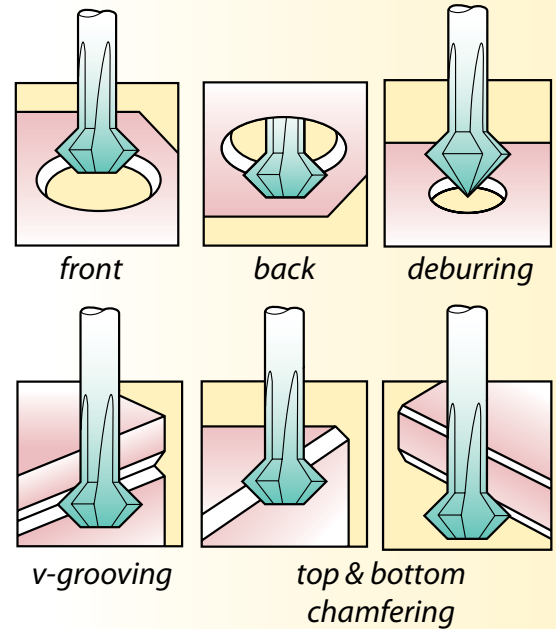

For super finish operations, Bi-face has a constant relieved profile. Longitudinal or interpolated work for front and back chamfering of edges and holes.

AUTO BODY DRILL BITS TO DISCONNECT SPOT WELDS

The machining of hard sheets has to be done with coated tools.

The high performance series **8203-H** is made from **Hard'X** coated carbide.

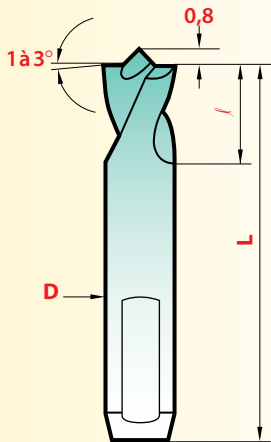
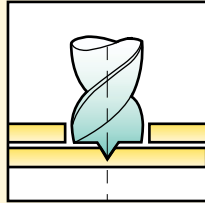

Tolerances

D	L	l
h8	± 1	+1

The centering point grants perfect drilling without any drifting or walking.

Thanks to the special sharpening the first sheet will be bored without damage to the second one.

This design allows for excellent penetration, a high resistance to wear and a great many regrinds.

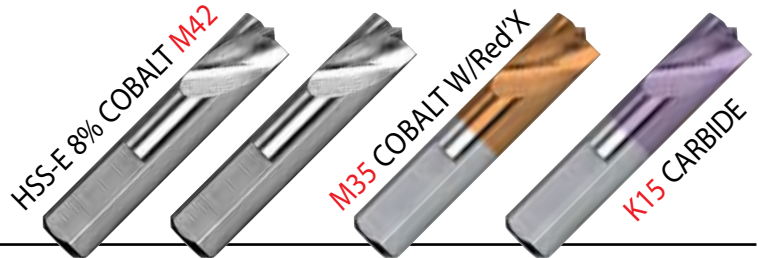

Short series

Diameter		L	l	Cobalt 202	Cobalt 203	M35/Red'X 2901	K15/Hard'X 8203-H
inch	mm						
.236	6	1-3/4	.590		2030600	29030600	
5/16		1-1/2	.590	2020800			
5/16		1-3/4	.590		2030800	29030800	8203H0800

- Easy to start
- Long lasting
- Will spot and drill one panel only, without walking

These short drills are specially designed to be used with the two types of hand type pneumatic disconnecter tools :

- with swan-neck = magafor 202
- with revolver-handle = magafor 203

Flatted shanks with 60° taper for a good location in the disconnecter.



Long series

Diameter		L	l	Cobalt 201	M35/Red'X 2901
inch	mm				
.236	6	2-5/8	1.100	2010600	29010600
.275	7	2-7/8	1.340	2010700	29010700
5/16		3-1/8	1.450	2010800	29010800
.394	10	3-1/2	1.690	2011000	29011000

To be used with standard drilling machines.

K15 CARBIDE — 6.5 - 7% Cobalt (0,006 - 0,008mm grain size)

CONDITIONS
USING RECOMMENDATIONS

DEBURRING
COUNTERSINKING

COUNTERSINKING

SFM = Speed : Surface Feet Per Minute

IPM = Feed : Inches Per Minute

$$RPM = \frac{SFM \times 12}{3.14 \times Diameter}$$

Example:

3/4" - .750 Diameter 3 Flute to Countersink 304 SS

$$RPM = \frac{45 \times 12}{3.14 \times .750} = \frac{540}{2.35} = 230 \text{ RPM}$$



Recommendation N° 1



Recommendation N° 2

		DEBURRING - COUNTERSINKING										CONTOURING					
MATERIAL		HSS.Co +TIN		HSS.Co +TIN		HSS.Co +TIN		HSS.8%Co +Red'X		Carbure/Carbide +Hard'X		HSS.Co +TIN		HSS.8%Co +Red'X		Carbure/Carbide +Hard'X	
Steel < 81 HRB (B)	SFM	115-148	115-148	115-148	115-148	55-70	55-70	112-145	112-145	128-256	128-256	55-70	55-70	112-145	112-145	128-256	128-256
	Ø10 IPM	6.5	6.5	6.5	6.5	3.4	3.4	6.5	6.5	10	10	3.4	3.4	6.5	6.5	10	10
	Ø20 IPM	3.4	3.4	3.4	3.4	1.8	1.8	3.4	3.4	5	5	1.8	1.8	3.4	3.4	5	5
Steel < 24 Rc	SFM	65-95	65-95	65-95	65-95	32-48	32-48	65-95	65-95	95-160	95-160	32-48	32-48	65-95	65-95	95-160	95-160
	Ø10 IPM	4.3	4.3	4.3	4.3	2.4	2.4	4.3	4.3	6.6	6.6	2.4	2.4	4.3	4.3	6.6	6.6
	Ø20 IPM	2	2	2	2	1.2	1.2	2	2	3.4	3.4	1.2	1.2	2	2	3.4	3.4
Steel 24 - 32 Rc	SFM	48-64	48-64	48-64	48-64	25-38	25-38	48-64	48-64	64-128	64-128	25-38	25-38	48-64	48-64	64-128	64-128
	Ø10 IPM	2	2	2	2	1.4	1.4	2	2	4	4	1.4	1.4	2	2	4	4
	Ø20 IPM	1.4	1.4	1.4	1.4	0.8	0.8	1.4	1.4	2.4	2.4	1	1	1.4	1.4	2.4	2.4
Stainless steel 32 - 41 Rc	SFM	38-48	38-48	38-48	38-48	20-32	20-32	38-48	38-48	64-128	64-128	20-32	20-32	38-48	38-48	64-128	64-128
	Ø10 IPM	1.8	1.8	1.8	1.8	1.2	1.2	1.8	1.8	4	4	1.2	1.2	1.8	1.8	4	4
	Ø20 IPM	1	1	1	1	0.6	0.6	1	1	2.4	2.4	0.6	0.6	1	1	2.4	2.4
Abrasion resistant steel	SFM							38-48	38-48	48-64	48-64			38-48	38-48	48-64	48-64
	Ø10 IPM							1.6	2	2			1.6	2	2		
	Ø20 IPM							1.2	1.4	1.4			1.2	1.4	1.4		
Inconel	SFM							13-20	13-20	32-38	32-38			13-20	13-20	32-38	32-38
	Ø10 IPM							0.6	0.6	1.2	1.2			0.6	0.6	1.2	1.2
	Ø20 IPM							0.3	0.3	0.6	0.6			0.3	0.3	0.6	0.6
Cast iron	SFM	64-128	64-128	64-128	64-128	48-80	48-80	64-128	64-128	128-256	128-256	48-80	48-80	64-128	64-128	128-256	128-256
	Ø10 IPM	5	5	5	5	2.8	2.8	5	5	0.3	0.3	2.8	2.8	5	5	0.3	0.3
	Ø20 IPM	3	3	3	3	1.6	1.6	3	3	6	6	1.6	1.6	3	3	6	6
Aluminium	SFM	160-190	160-190	160-190	160-190	112-145	112-145	160-190	160-190	128-320	128-320	112-145	112-145	160-190	160-190	128-320	128-320
	Ø10 IPM	10	10	10	10	7.8	7.8	10	10	13.8	13.8	7.8	7.8	10	10	13.8	13.8
	Ø20 IPM	7	7	7	7	5.2	5.2	7	7	9	9	5.2	5.2	7	7	9	9
Bronze Brass	SFM	96-128	96-128	96-128	96-128	65-95	65-95	96-128	96-128			65-95	65-95	96-128	96-128		
	Ø10 IPM	6	6	6	6	4.7	4.7	6	6			4.7	4.7	6	6		
	Ø20 IPM	4.3	4.3	4.3	4.3	3.4	3.4	4.3	4.3			3.4	3.4	4.3	4.3		
Copper	SFM	65-95	65-95	65-95	65-95	48-80	48-80	65-95	65-95	160-256	160-256	48-80	48-80	65-95	65-95	160-256	160-256
	Ø10 IPM	4.7	4.7	4.7	4.7	3.75	3.75	4.7	4.7	12	12	3.75	3.75	4.7	4.7	12	12
	Ø20 IPM	3	3	3	3	2.4	2.4	3	3	7.8	7.8	2.4	2.4	3	3	7.8	7.8
Laminated	SFM	160-320	160-320	160-320	160-320	112-224	112-224	112-224	112-224			112-224	112-224	112-224	112-224		
	Ø10 IPM	16	16	16	16	12	12	12	12			12	12	12	12		
	Ø20 IPM	12	12	12	12	8	8	8	8			8	8	8	8		
Nylon, PVC Plastics	SFM	160-320	160-320	160-320	160-320	112-224	112-224	112-224	112-224			112-224	112-224	112-224	112-224		
	Ø10 IPM	18	18	18	18	16	16	16	16			16	16	16	16		
	Ø20 IPM	13.8	13.8	13.8	13.8	12	12	12	12			12	12	12	12		



HIGH PRECISION



REAMERS

REAMERS

1 - HOW TO CHOOSE STANDARD INCH REAMERS

Examples	REAMING (Hole)		REAMER (Tool)	
	Ø	Tolerance	Ø	Tolerance
1	1/64" +.00006 -.00012	.01568" .01550"	EDP # 861000395 .01551"	.01559" .01551"
2	1/32" +.0001 -.0002	.03135" .03105"	EDP # 86000079 .03110"	.03122" .03110"
3	1/16" +.0004 -.0001	.0629" .0624"	EDP # 86000159 .0626"	.06272" .06260"

Example 3 explanation

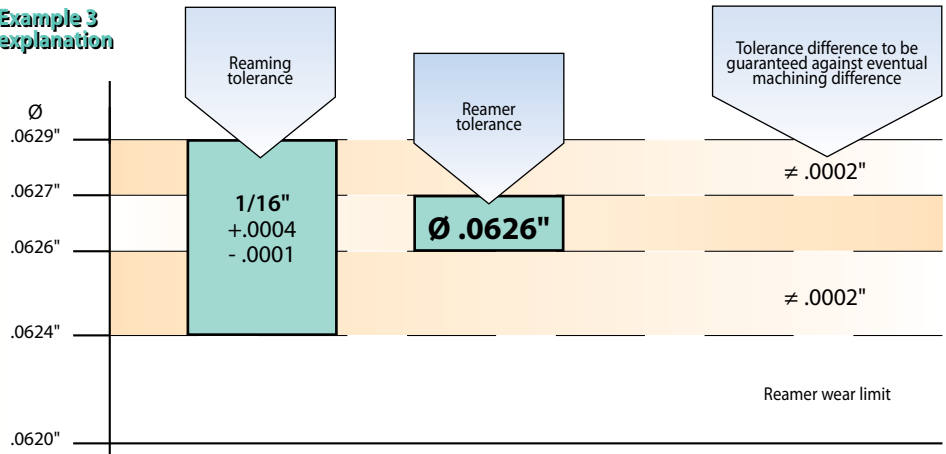

2 - HOW TO CHOOSE METRIC REAMERS

Code 8610 - 8600 : pages 37-41

Tolerance	Ø 2	Ø 3	Ø 4	Ø 5	Ø 6	Ø 8	Ø 10	Ø 12	Ø 14
D10	2,04	3,04	4,05	5,06	6,06	8,07	10,08	12,10	14,10
E 8	2,02	3,02	4,03	5,03	6,03	8,03	10,03	12,04	14,04
E 9	2,03	3,03	4,04	5,04	6,04	8,05	10,05	12,06	14,06
F 7	2,01	3,01	4,01	5,01	6,01	8,02	10,02	12,02	14,02
F 8	2,01	3,01	4,02	5,02	5,02	8,02	10,02	12,03	14,03
G 7	2,00	3,00	4,01	5,02	5,02	8,01	10,01	12,01	14,01
H 6	2,00	3,00	4,00	5,00	6,00	8,00	10,00	12,00	14,00
H 8	2,01	3,01	4,01	5,01	6,01	8,01	10,01	12,01	14,01
H 9	2,01	3,01	4,02	5,02	6,02	8,02	10,02	12,03	14,03
M 7	1,99	2,99	3,99	4,99	5,99	7,99	9,99	11,99	13,99
N 7	1,99	2,99	3,99	4,99	5,99	7,98	9,98	11,98	13,98
P 7	1,99	2,99	3,98	4,98	5,98	7,98	9,98	11,97	13,97
R 7	1,98	2,98	3,98	4,98	5,98	7,98	9,98	11,97	13,97

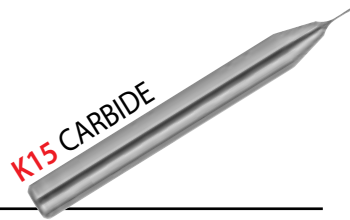

HIGH PRECISION MICRO-REAMERS

REAMING

MICRO-PRECISION

D .0002" increment	.1	.2	magaforce 8610
.0079 to .0096	.036	.079	EDP # SEE BELOW
.0098 to .0116	.043	.098	
.0118 to .0136	.055	.118	
.0138 to .0156	.067	.138	
.0157 to .0195	.079	.157	
.0197 to .0234	.091	.197	

Micro-reamers manufactured and stocked in all diameters at every .0002" increment. Their reinforced shank offers a greater stability necessary for these high precision tools.

K15 CARBIDE — 6.5 - 7% Cobalt (0,006 - 0,008mm grain size)

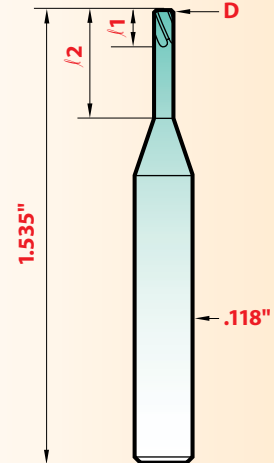

TOLERANCE ± .00004"

4 flutes, 20 degree left spiral, right hand cut.

EDP 8610				SIZE
#	mm	Decimal	inch	Wire
86100	0.200	.0079		92
86100	0.205	.0081		
86100	0.210	.0083		91
86100	0.215	.0085		
86100	0.220	.0087		90
86100	0.225	.0089		
86100	0.230	.0091		89
86100	0.235	.0093		
86100	0.240	.0094		88
86100	0.245	.0096		
86100	0.250	.0098		
86100	0.255	.0100		87
86100	0.260	.0102		
86100	0.265	.0104		86
86100	0.270	.0106		
86100	0.275	.0108		
86100	0.280	.0110		85
86100	0.285	.0112		
86100	0.290	.0114		84
86100	0.295	.0116		
86100	0.300	.0118		
86100	0.305	.0120		83
86100	0.310	.0122		
86100	0.315	.0124		82
86100	0.320	.0126		
86100	0.325	.0128		
86100	0.330	.0130		81

EDP 8610					SIZE
#	mm	Decimal	inch	Wire	
86100	0.335	.0132			
86100	0.340	.0134		80	
86100	0.345	.0136			
86100	0.350	.0138			
86100	0.355	.0140			
86100	0.360	.0142			
86100	0.365	.0144		79	
86100	0.370	.0146			
86100	0.375	.0148			
86100	0.380	.0150			
86100	0.385	.0152			
86100	0.390	.0154			
86100	0.395	.0156	1/64		
86100	0.400	.0157			
86100	0.405	.0159		78	
86100	0.410	.0161			
86100	0.415	.0163			
86100	0.420	.0165			
86100	0.425	.0167			
86100	0.430	.0169			
86100	0.435	.0171			
86100	0.440	.0173			
86100	0.445	.0175			
86100	0.450	.0177			
86100	0.455	.0179		77	
86100	0.460	.0181			
86100	0.465	.0183			

EDP 8610					SIZE
#	mm	Decimal	inch	Wire	
86100	0.470	.0185			
86100	0.475	.0187			
86100	0.480	.0189			
86100	0.485	.0191			
86100	0.490	.0193			
86100	0.495	.0195			
86100	0.500	.0197			
86100	0.505	.0199		76	
86100	0.510	.0201			
86100	0.515	.0203			
86100	0.520	.0205			
86100	0.525	.0207			
86100	0.530	.0209		75	
86100	0.535	.0211			
86100	0.540	.0213			
86100	0.545	.0215			
86100	0.550	.0217			
86100	0.555	.0219			
86100	0.560	.0220			
86100	0.565	.0222			
86100	0.570	.0224		74	
86100	0.575	.0226			
86100	0.580	.0228			
86100	0.585	.0230			
86100	0.590	.0232			
86100	0.595	.0234			

HIGH PRECISION MINIATURE REAMERS



K15 CARBIDE

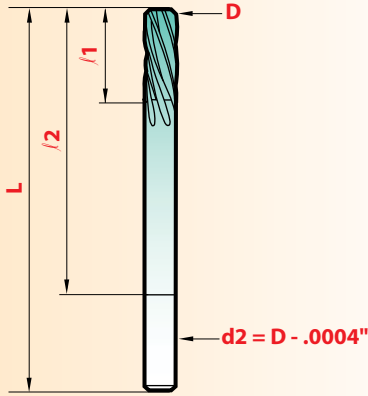
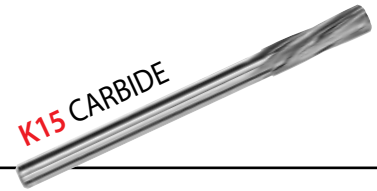

MICRO-PRECISION

D .0004" increment	/1	/2	L	d2	magaforce 8600
.0236 to .0413	.275	.393	1.30	D	EDP # SEE BELOW
.0417 to .0610	.393	.944	1.58	D	
.0614 to .0929	.433	1.220	1.97	D	
.0933 to .1476	.590	1.500	2.25	D	
.1480 to .1673	.748	1.930	2.95	.158	
.1677 to .1870	.827	2"	3.15	.177	
.1874 to .2087	.906	2.32	3.39	.197	
.209 to .228	1.024	2.560	3.66	.216	
.229 to .263	1.100	2.795	3.975	.236	
.2642 to .2972	1.220	3.071	4.29	.276	
.2976 to .3366	1.299	3.307	4.61	.315	
.3370 to .3760	1.417	3.465	4.92	.354	

TOLERANCE 0 + .00012"

All reamers have a 45° chamfer lead
 Ø .0236" to .0929" = 4 flutes, Ø .0933" to .5138" = 6 flutes,
 10 degree left spiral/right hand cut for through holes.

Note: larger sizes up to .790" Code 8600 and/or HSS-CO M35 Code 600 are available within 2 weeks. Call for information

EDP 8600					EDP 8600					EDP 8600					EDP 8600									
#	mm	Decimal	inch	Wire	#	mm	Decimal	inch	Wire	#	mm	Decimal	inch	Wire	#	mm	Decimal	inch	Wire	#	mm	Decimal	inch	Wire
86000	0.60	.0236			86000	0.88	.0346			86000	1.16	.0457			86000	1.44	.0567			86000	1.71	.0673		
86000	0.61	.0240		73	86000	0.89	.0350		65	86000	1.17	.0461			86000	1.45	.0571			86000	1.72	.0677		
86000	0.62	.0244			86000	0.90	.0354			86000	1.18	.0465		56	86000	1.46	.0575			86000	1.73	.0681		
86000	0.63	.0248		72	86000	0.91	.0358		64	86000	1.19	.0469	3/64		86000	1.47	.0579			86000	1.74	.0685		
86000	0.64	.0252			86000	0.92	.0362			86000	1.20	.0472			86000	1.48	.0583			86000	1.75	.0689		
86000	0.65	.0256			86000	0.93	.0366			86000	1.21	.0476			86000	1.49	.0587			86000	1.76	.0693		
86000	0.66	.0260		71	86000	0.94	.0370		63	86000	1.22	.0480			86000	1.50	.0590			86000	1.77	.0697		
86000	0.67	.0264			86000	0.95	.0374			86000	1.23	.0484			86000	1.51	.0594		53	86000	1.78	.0701		
86000	0.68	.0268			86000	0.96	.0378		62	86000	1.24	.0488			86000	1.52	.0598			86000	1.79	.0705		
86000	0.69	.0272			86000	0.97	.0382			86000	1.25	.0492			86000	1.53	.0602			86000	1.80	.0709		
86000	0.70	.0276			86000	0.98	.0386			86000	1.26	.0496			86000	1.54	.0606			86000	1.81	.0713		
86000	0.71	.0280		70	86000	0.99	.0390		61	86000	1.27	.0500			86000	1.55	.0610			86000	1.82	.0717		
86000	0.72	.0283			86000	1.00	.0394			86000	1.28	.0504			86000	1.56	.0614			86000	1.83	.0721		
86000	0.73	.0287			86000	1.01	.0398		60	86000	1.29	.0508			86000	1.57	.0618			86000	1.84	.0725		
86000	0.74	.0291		69	86000	1.02	.0402			86000	1.30	.0512			86000	1.58	.0622			86000	1.85	.0729		
86000	0.75	.0295			86000	1.03	.0406			86000	1.31	.0516			86000	1.59	.0626	1/16		86000	1.86	.0733		
86000	0.76	.0299			86000	1.04	.0409		59	86000	1.32	.0520		55	86000	1.60	.0630			86000	1.87	.0737		
86000	0.77	.0303			86000	1.05	.0413			86000	1.33	.0524			86000	1.61	.0634		52	86000	1.88	.0741		
86000	0.78	.0307			86000	1.06	.0417			86000	1.34	.0528			86000	1.62	.0638			86000	1.89	.0745		
86000	0.79	.0311	1/32	68	86000	1.07	.0421		58	86000	1.35	.0531			86000	1.63	.0642			86000	1.90	.0749		
86000	0.80	.0315			86000	1.08	.0425			86000	1.36	.0535			86000	1.64	.0646			86000	1.91	.0753		
86000	0.81	.0319		67	86000	1.09	.0429		57	86000	1.37	.0539			86000	1.65	.0650			86000	1.92	.0757		
86000	0.82	.0323			86000	1.10	.0433			86000	1.38	.0543			86000	1.66	.0654			86000	1.93	.0761		
86000	0.83	.0327			86000	1.11	.0437			86000	1.39	.0547			86000	1.67	.0657			86000	1.94	.0765		
86000	0.84	.0331		66	86000	1.12	.0441			86000	1.40	.0551		54	86000	1.68	.0661			86000	1.95	.0769		
86000	0.85	.0335			86000	1.13	.0445			86000	1.41	.0555			86000	1.69	.0665			86000	1.96	.0773		
86000	0.86	.0339			86000	1.14	.0449			86000	1.42	.0559			86000	1.70	.0669		51	86000	1.97	.0777		
86000	0.87	.0343			86000	1.15	.0453			86000	1.43	.0563			86000	1.71	.0673			86000	1.98	.0781		

EDP 8600					EDP 8600					EDP 8600					EDP 8600										
				SIZE					SIZE					SIZE					SIZE						
#	mm	Decimal	inch	Wire	#	mm	Decimal	inch	Wire	#	mm	Decimal	inch	Wire	#	mm	Decimal	inch	Wire	#	mm	Decimal	inch	Wire	
86000	1.72	.0677			86000	2.18	.0858		44	86000	2.64	.1039		37	86000	3.10	.1220			86000	3.10	.1220			
86000	1.73	.0681			86000	2.19	.0862			86000	2.65	.1043			86000	3.11	.1224			86000	3.11	.1224			
86000	1.74	.0685			86000	2.20	.0866			86000	2.66	.1047			86000	3.12	.1228			86000	3.12	.1228			
86000	1.75	.0689			86000	2.21	.0870			86000	2.67	.1051			86000	3.13	.1232			86000	3.13	.1232			
86000	1.76	.0693			86000	2.22	.0874			86000	2.68	.1055			86000	3.14	.1236			86000	3.14	.1236			
86000	1.77	.0697			86000	2.23	.0878			86000	2.69	.1059			86000	3.15	.1240			86000	3.15	.1240			
86000	1.78	.0701		50	86000	2.24	.0882			86000	2.70	.1063		36	86000	3.16	.1244			86000	3.16	.1244			
86000	1.79	.0705			86000	2.25	.0886			86000	2.71	.1067			86000	3.17	.1248		1/8	86000	3.17	.1248		1/8	
86000	1.80	.0709			86000	2.26	.0890		43	86000	2.72	.1071			86000	3.18	.1252			86000	3.18	.1252			
86000	1.81	.0713			86000	2.27	.0894			86000	2.73	.1075			86000	3.19	.1256			86000	3.19	.1256			
86000	1.82	.0717			86000	2.28	.0898			86000	2.74	.1079			86000	3.20	.1260			86000	3.20	.1260			
86000	1.83	.0720			86000	2.29	.0902			86000	2.75	.1083			86000	3.21	.1264			86000	3.21	.1264			
86000	1.84	.0724			86000	2.30	.0906			86000	2.76	.1087			86000	3.22	.1268			86000	3.22	.1268			
86000	1.85	.0728		49	86000	2.31	.0909			86000	2.77	.1091			86000	3.23	.1272			86000	3.23	.1272			
86000	1.86	.0732			86000	2.32	.0913			86000	2.78	.1094		7/64	86000	3.24	.1276			86000	3.24	.1276			
86000	1.87	.0736			86000	2.33	.0917			86000	2.79	.1098		35	86000	3.25	.1280			86000	3.25	.1280			
86000	1.88	.0740			86000	2.34	.0921			86000	2.80	.1102			86000	3.26	.1283			30	86000	3.26	.1283		30
86000	1.89	.0744			86000	2.35	.0925			86000	2.81	.1106			86000	3.27	.1287			86000	3.27	.1287			
86000	1.90	.0748			86000	2.36	.0929			86000	2.82	.1110		34	86000	3.28	.1291			86000	3.28	.1291			
86000	1.91	.0752			86000	2.37	.0933		42	86000	2.83	.1114			86000	3.29	.1295			86000	3.29	.1295			
86000	1.92	.0756			86000	2.38	.0937		3/32	86000	2.84	.1118			86000	3.30	.1299			86000	3.30	.1299			
86000	1.93	.0760		48	86000	2.39	.0941			86000	2.85	.1122			86000	3.31	.1303			86000	3.31	.1303			
86000	1.94	.0764			86000	2.40	.0945			86000	2.86	.1126			86000	3.32	.1308			86000	3.32	.1308			
86000	1.95	.0768			86000	2.41	.0949			86000	2.87	.1130		33	86000	3.33	.1311			86000	3.33	.1311			
86000	1.96	.0772			86000	2.42	.0953			86000	2.88	.1134			86000	3.34	.1315			86000	3.34	.1315			
86000	1.97	.0776			86000	2.43	.0957			86000	2.89	.1138			86000	3.35	.1319			86000	3.35	.1319			
86000	1.98	.0780		5/64	86000	2.44	.0961		41	86000	2.90	.1142			86000	3.36	.1323			86000	3.36	.1323			
86000	1.99	.0783		47	86000	2.45	.0965			86000	2.91	.1146			86000	3.37	.1327			86000	3.37	.1327			
86000	2.00	.0787			86000	2.46	.0969			86000	2.92	.1150			86000	3.38	.1331			86000	3.38	.1331			
86000	2.01	.0791			86000	2.47	.0972			86000	2.93	.1154			86000	3.39	.1335			86000	3.39	.1335			
86000	2.02	.0795			86000	2.48	.0976			86000	2.94	.1157			86000	3.40	.1339			86000	3.40	.1339			
86000	2.03	.0799			86000	2.49	.0980		40	86000	2.95	.1161		32	86000	3.41	.1343			86000	3.41	.1343			
86000	2.04	.0803			86000	2.50	.0984			86000	2.96	.1165			86000	3.42	.1346			86000	3.42	.1346			
86000	2.05	.0807			86000	2.51	.0988			86000	2.97	.1169			86000	3.43	.1350			86000	3.43	.1350			
86000	2.06	.0811		46	86000	2.52	.0992			86000	2.98	.1173			86000	3.44	.1354			86000	3.44	.1354			
86000	2.07	.0815			86000	2.53	.0996		39	86000	2.99	.1177			86000	3.45	.1358			29	86000	3.45	.1358		29
86000	2.08	.0819		45	86000	2.54	.1000			86000	3.00	.1181			86000	3.46	.1362			86000	3.46	.1362			
86000	2.09	.0823			86000	2.55	.1004			86000	3.01	.1185			86000	3.47	.1366			86000	3.47	.1366			
86000	2.10	.0827			86000	2.56	.1008			86000	3.02	.1189			86000	3.48	.1370			86000	3.48	.1370			
86000	2.11	.0831			86000	2.57	.1012			86000	3.03	.1193			86000	3.49	.1374			86000	3.49	.1374			
86000	2.12	.0835			86000	2.58	.1016		38	86000	3.04	.1197			86000	3.50	.1378			86000	3.50	.1378			
86000	2.13	.0839			86000	2.59	.1020			86000	3.05	.1201		31	86000	3.51	.1382			86000	3.51	.1382			
86000	2.14	.0843			86000	2.60	.1024			86000	3.06	.1205			86000	3.52	.1386			86000	3.52	.1386			
86000	2.15	.0846			86000	2.61	.1028			86000	3.07	.1209			86000	3.53	.1390			86000	3.53	.1390			
86000	2.16	.0850			86000	2.62	.1031			86000	3.08	.1213			86000	3.54	.1394			86000	3.54	.1394			
86000	2.17	.0854			86000	2.63	.1035			86000	3.09	.1217			86000	3.55	.1398			86000	3.55	.1398			

EDP 8600					SIZE	EDP 8600					SIZE	EDP 8600					SIZE	EDP 8600					SIZE						
#	mm	Decimal	inch	Wire		#	mm	Decimal	inch	Wire		#	mm	Decimal	inch	Wire		#	mm	Decimal	inch	Wire		#	mm	Decimal	inch	Wire	
86000	3.56	.1402				86000	4.02	.1583				86000	4.48	.1764				86000	4.94	.1945				86000	4.94	.1945			
86000	3.57	.1406	9/64	28		86000	4.03	.1587				86000	4.49	.1768		16		86000	4.95	.1949				86000	4.95	.1949			
86000	3.58	.1409				86000	4.04	.1591		21		86000	4.50	.1772				86000	4.96	.1953				86000	4.96	.1953			
86000	3.59	.1413				86000	4.05	.1594				86000	4.51	.1776				86000	4.97	.1957				86000	4.97	.1957			
86000	3.60	.1417				86000	4.06	.1598				86000	4.52	.1780				86000	4.98	.1961		9		86000	4.98	.1961		9	
86000	3.61	.1421				86000	4.07	.1602				86000	4.53	.1783				86000	4.99	.1965				86000	4.99	.1965			
86000	3.62	.1425				86000	4.08	.1606				86000	4.54	.1787				86000	5.00	.1969				86000	5.00	.1969			
86000	3.63	.1429				86000	4.09	.1610		20		86000	4.55	.1791				86000	5.01	.1972				86000	5.01	.1972			
86000	3.64	.1433				86000	4.10	.1614				86000	4.56	.1795				86000	5.02	.1976				86000	5.02	.1976			
86000	3.65	.1437				86000	4.11	.1618				86000	4.57	.1799		15		86000	5.03	.1980				86000	5.03	.1980			
86000	3.66	.1441		27		86000	4.12	.1622				86000	4.58	.1803				86000	5.04	.1984				86000	5.04	.1984			
86000	3.67	.1445				86000	4.13	.1626				86000	4.59	.1807				86000	5.05	.1988		8		86000	5.05	.1988		8	
86000	3.68	.1449				86000	4.14	.1630				86000	4.60	.1811				86000	5.06	.1992				86000	5.06	.1992			
86000	3.69	.1453				86000	4.15	.1634				86000	4.61	.1815				86000	5.07	.1996				86000	5.07	.1996			
86000	3.70	.1457				86000	4.16	.1638				86000	4.62	.1819		14		86000	5.08	.2000				86000	5.08	.2000			
86000	3.71	.1461				86000	4.17	.1642				86000	4.63	.1823				86000	5.09	.2004				86000	5.09	.2004			
86000	3.72	.1465				86000	4.18	.1646				86000	4.64	.1827				86000	5.10	.2008		7		86000	5.10	.2008		7	
86000	3.73	.1469		26		86000	4.19	.1650				86000	4.65	.1831				86000	5.11	.2012				86000	5.11	.2012			
86000	3.74	.1472				86000	4.20	.1654				86000	4.66	.1835				86000	5.12	.2016				86000	5.12	.2016			
86000	3.75	.1476				86000	4.21	.1657				86000	4.67	.1839				86000	5.13	.2020				86000	5.13	.2020			
86000	3.76	.1480				86000	4.22	.1661		19		86000	4.68	.1843				86000	5.14	.2024				86000	5.14	.2024			
86000	3.77	.1484				86000	4.23	.1665				86000	4.69	.1846				86000	5.15	.2028				86000	5.15	.2028			
86000	3.78	.1488				86000	4.24	.1669				86000	4.70	.1850		13		86000	5.16	.2031	13/64			86000	5.16	.2031	13/64		
86000	3.79	.1492				86000	4.25	.1673				86000	4.71	.1854				86000	5.17	.2035				86000	5.17	.2035			
86000	3.80	.1496		25		86000	4.26	.1677				86000	4.72	.1858				86000	5.18	.2039		6		86000	5.18	.2039		6	
86000	3.81	.1500				86000	4.27	.1681				86000	4.73	.1862				86000	5.19	.2043				86000	5.19	.2043			
86000	3.82	.1504				86000	4.28	.1685				86000	4.74	.1866				86000	5.20	.2047				86000	5.20	.2047			
86000	3.83	.1508				86000	4.29	.1689				86000	4.75	.1870				86000	5.21	.2051				86000	5.21	.2051			
86000	3.84	.1512				86000	4.30	.1693		18		86000	4.76	.1874	3/16			86000	5.22	.2055		5		86000	5.22	.2055		5	
86000	3.85	.1516				86000	4.31	.1697				86000	4.77	.1878				86000	5.23	.2059				86000	5.23	.2059			
86000	3.86	.1520		24		86000	4.32	.1701				86000	4.78	.1882				86000	5.24	.2063				86000	5.24	.2063			
86000	3.87	.1524				86000	4.33	.1705				86000	4.79	.1886				86000	5.25	.2067				86000	5.25	.2067			
86000	3.88	.1528				86000	4.34	.1709				86000	4.80	.1890		12		86000	5.26	.2071				86000	5.26	.2071			
86000	3.89	.1531				86000	4.35	.1713				86000	4.81	.1984				86000	5.27	.2075				86000	5.27	.2075			
86000	3.90	.1535				86000	4.36	.1717				86000	4.82	.1898				86000	5.28	.2079				86000	5.28	.2079			
86000	3.91	.1539		23		86000	4.37	.1720	11/64			86000	4.83	.1902				86000	5.29	.2083				86000	5.29	.2083			
86000	3.92	.1543				86000	4.38	.1724				86000	4.84	.1906				86000	5.30	.2087				86000	5.30	.2087			
86000	3.93	.1547				86000	4.39	.1728		17		86000	4.85	.1909		11		86000	5.31	.2091		4		86000	5.31	.2091		4	
86000	3.94	.1551				86000	4.40	.1732				86000	4.86	.1913				86000	5.32	.2094				86000	5.32	.2094			
86000	3.95	.1555				86000	4.41	.1736				86000	4.87	.1917				86000	5.33	.2098				86000	5.33	.2098			
86000	3.96	.1559				86000	4.42	.1740				86000	4.88	.1921				86000	5.34	.2102				86000	5.34	.2102			
86000	3.97	.1563	5/32			86000	4.43	.1744				86000	4.89	.1925				86000	5.35	.2106				86000	5.35	.2106			
86000	3.98	.1567				86000	4.44	.1748				86000	4.90	.1929				86000	5.36	.2110				86000	5.36	.2110			
86000	3.99	.1571		22		86000	4.45	.1752				86000	4.91	.1933		10		86000	5.37	.2114				86000	5.37	.2114			
86000	4.00	.1575				86000	4.46	.1756				86000	4.92	.1937				86000	5.38	.2118				86000	5.38	.2118			
86000	4.01	.1579				86000	4.47	.1760				86000	4.93	.1941				86000	5.39	.2122				86000	5.39	.2122			

EDP 8600					EDP 8600					EDP 8600					EDP 8600									
				SIZE					SIZE					SIZE					SIZE					
#	mm	Decimal	inch	Wire	#	mm	Decimal	inch	Wire	#	mm	Decimal	inch	Wire	#	mm	Decimal	inch	Wire	#	mm	Decimal	inch	Wire
86000	5.40	.2126			86000	5.86	.2307			86000	6.32	.2488			86000	6.78	.2669			86000	7.14	.2811	9/32	K
86000	5.41	.2130		3	86000	5.87	.2311			86000	6.33	.2492			86000	6.79	.2673			86000	7.15	.2815		
86000	5.42	.2134			86000	5.88	.2315			86000	6.34	.2496			86000	6.80	.2677			86000	7.16	.2819		
86000	5.43	.2138			86000	5.89	.2319			86000	6.35	.2500	1/4	E	86000	6.81	.2681			86000	7.17	.2823		
86000	5.44	.2142			86000	5.90	.2323			86000	6.36	.2504			86000	6.82	.2685			86000	7.18	.2827		
86000	5.45	.2146			86000	5.91	.2327			86000	6.37	.2508			86000	6.83	.2689			86000	7.19	.2831		
86000	5.46	.2150			86000	5.92	.2331			86000	6.38	.2512			86000	6.84	.2693			86000	7.20	.2835		
86000	5.47	.2154			86000	5.93	.2335			86000	6.39	.2517			86000	6.85	.2697			86000	7.21	.2839		
86000	5.48	.2158			86000	5.94	.2339		A	86000	6.40	.2520			86000	6.86	.2701			86000	7.22	.2843		
86000	5.49	.2161			86000	5.95	.2343	15/64		86000	6.41	.2524			86000	6.87	.2705			86000	7.23	.2846		
86000	5.50	.2165			86000	5.96	.2347			86000	6.42	.2528			86000	6.88	.2709			86000	7.24	.2850		
86000	5.51	.2169			86000	5.97	.2350			86000	6.43	.2531			86000	6.89	.2713			86000	7.25	.2854		
86000	5.52	.2173			86000	5.98	.2354			86000	6.44	.2535			86000	6.90	.2717			86000	7.26	.2858		
86000	5.53	.2177			86000	5.99	.2358			86000	6.45	.2539			86000	6.91	.2720		I	86000	7.27	.2862		
86000	5.54	.2181			86000	6.00	.2362			86000	6.46	.2543			86000	6.92	.2724			86000	7.28	.2866		
86000	5.55	.2185			86000	6.01	.2366			86000	6.47	.2547			86000	6.93	.2728			86000	7.29	.2870		
86000	5.56	.2189	7/32		86000	6.02	.2370			86000	6.48	.2551			86000	6.94	.2732			86000	7.30	.2874		
86000	5.57	.2193			86000	6.03	.2374			86000	6.49	.2555			86000	6.95	.2736			86000	7.31	.2878		
86000	5.58	.2197			86000	6.04	.2378			86000	6.50	.2559			86000	6.96	.2740			86000	7.32	.2882		
86000	5.59	.2201			86000	6.05	.2382		B	86000	6.51	.2563			86000	6.97	.2744			86000	7.33	.2886		
86000	5.60	.2205			86000	6.06	.2386			86000	6.52	.2567			86000	6.98	.2748			86000	7.34	.2890		
86000	5.61	.2209		2	86000	6.07	.2390			86000	6.53	.2571		F	86000	6.99	.2752			86000	7.35	.2894		
86000	5.62	.2213			86000	6.08	.2394			86000	6.54	.2575			86000	7.00	.2756			86000	7.36	.2898		
86000	5.63	.2217			86000	6.09	.2398			86000	6.55	.2579			86000	7.01	.2760			86000	7.37	.2902		
86000	5.64	.2220			86000	6.10	.2402			86000	6.56	.2583			86000	7.02	.2764			86000	7.38	.2906		
86000	5.65	.2224			86000	6.11	.2406			86000	6.57	.2587			86000	7.03	.2768		J	86000	7.39	.2910		
86000	5.66	.2228			86000	6.12	.2410			86000	6.58	.2591			86000	7.04	.2772			86000	7.40	.2914		
86000	5.67	.2232			86000	6.13	.2413			86000	6.59	.2594			86000	7.05	.2776			86000	7.41	.2918		
86000	5.68	.2236			86000	6.14	.2417			86000	6.60	.2598			86000	7.06	.2780			86000	7.42	.2922		
86000	5.69	.2240			86000	6.15	.2421		C	86000	6.61	.2602			86000	7.07	.2783			86000	7.43	.2926		
86000	5.70	.2244			86000	6.16	.2425			86000	6.62	.2606			86000	7.08	.2787			86000	7.44	.2930		
86000	5.71	.2248			86000	6.17	.2429			86000	6.63	.2610		G	86000	7.09	.2791			86000	7.45	.2934		
86000	5.72	.2252			86000	6.18	.2433			86000	6.64	.2614			86000	7.10	.2795			86000	7.46	.2938		
86000	5.73	.2256			86000	6.19	.2437			86000	6.65	.2618			86000	7.11	.2799			86000	7.47	.2942		
86000	5.74	.2260			86000	6.20	.2441			86000	6.66	.2622			86000	7.12	.2803			86000	7.48	.2946		
86000	5.75	.2264			86000	6.21	.2445			86000	6.67	.2626			86000	7.13	.2807			86000	7.49	.2950		
86000	5.76	.2268			86000	6.22	.2449			86000	6.68	.2630			86000	7.14	.2811	9/32	K	86000	7.50	.2954		
86000	5.77	.2272			86000	6.23	.2453			86000	6.69	.2634			86000	7.15	.2815			86000	7.51	.2958		
86000	5.78	.2276			86000	6.24	.2457			86000	6.70	.2638			86000	7.16	.2819			86000	7.52	.2962		
86000	5.79	.2280		1	86000	6.25	.2461		D	86000	6.71	.2642			86000	7.17	.2823			86000	7.53	.2966		
86000	5.80	.2284			86000	6.26	.2465			86000	6.72	.2646			86000	7.18	.2827			86000	7.54	.2970		
86000	5.81	.2288			86000	6.27	.2468			86000	6.73	.2650			86000	7.19	.2831			86000	7.55	.2974		
86000	5.82	.2291			86000	6.28	.2472			86000	6.74	.2654	17/64		86000	7.20	.2835			86000	7.56	.2978		
86000	5.83	.2295			86000	6.29	.2476			86000	6.75	.2657			86000	7.21	.2839			86000	7.57	.2982		
86000	5.84	.2299			86000	6.30	.2480			86000	6.76	.2661		H	86000	7.22	.2843			86000	7.58	.2986		
86000	5.85	.2303			86000	6.31	.2484			86000	6.77	.2665			86000	7.23	.2846			86000	7.59	.2990		

EDP 8600					EDP 8600					EDP 8600					EDP 8600				
				SIZE					SIZE					SIZE					SIZE
#	mm	Decimal	inch	Wire	#	mm	Decimal	inch	Wire	#	mm	Decimal	inch	Wire	#	mm	Decimal	inch	Wire
86000	7.24	.2850			86000	7.70	.3031			86000	8.16	.3213			86000	8.62	.3394		
86000	7.25	.2854			86000	7.71	.3035			86000	8.17	.3217			86000	8.63	.3398		
86000	7.26	.2858			86000	7.72	.3039			86000	8.18	.3220			86000	8.64	.3402		
86000	7.27	.2862			86000	7.73	.3043			86000	8.19	.3224			86000	8.65	.3406		
86000	7.28	.2866			86000	7.74	.3047			86000	8.20	.3228		P	86000	8.66	.3409		
86000	7.29	.2870			86000	7.75	.3051			86000	8.21	.3232			86000	8.67	.3413		
86000	7.30	.2874			86000	7.76	.3055			86000	8.22	.3236			86000	8.68	.3417		
86000	7.31	.2878			86000	7.77	.3059			86000	8.23	.3240			86000	8.69	.3421		
86000	7.32	.2882			86000	7.78	.3063			86000	8.24	.3244			86000	8.70	.3425		
86000	7.33	.2886			86000	7.79	.3067			86000	8.25	.3248			86000	8.71	.3429		
86000	7.34	.2890			86000	7.80	.3071			86000	8.26	.3252			86000	8.72	.3433		
86000	7.35	.2894			86000	7.81	.3075			86000	8.27	.3256			86000	8.73	.3437	11/32	
86000	7.36	.2898		L	86000	7.82	.3079			86000	8.28	.3260			86000	8.74	.3441		
86000	7.37	.2902			86000	7.83	.3083			86000	8.29	.3264			86000	8.75	.3445		
86000	7.38	.2906			86000	7.84	.3087			86000	8.30	.3268			86000	8.76	.3449		
86000	7.39	.2909			86000	7.85	.3091			86000	8.31	.3272			86000	8.77	.3453		
86000	7.40	.2913			86000	7.86	.3094			86000	8.32	.3276			86000	8.78	.3457		
86000	7.41	.2917			86000	7.87	.3098			86000	8.33	.3280	21/64		86000	8.79	.3461		
86000	7.42	.2921			86000	7.88	.3102			86000	8.34	.3283			86000	8.80	.3465		
86000	7.43	.2925			86000	7.89	.3106			86000	8.35	.3287			86000	8.81	.3469		
86000	7.44	.2929			86000	7.90	.3110			86000	8.36	.3291			86000	8.82	.3472		
86000	7.45	.2933			86000	7.91	.3114			86000	8.37	.3295			86000	8.83	.3476		
86000	7.46	.2937			86000	7.92	.3118			86000	8.38	.3299			86000	8.84	.3480		S
86000	7.47	.2941			86000	7.93	.3122			86000	8.39	.3303			86000	8.85	.3484		
86000	7.48	.2945			86000	7.94	.3126	5/16		86000	8.40	.3307			86000	8.86	.3488		
86000	7.49	.2949		M	86000	7.95	.3130			86000	8.41	.3311			86000	8.87	.3492		
86000	7.50	.2953			86000	7.96	.3134			86000	8.42	.3315			86000	8.88	.3496		
86000	7.51	.2957			86000	7.97	.3138			86000	8.43	.3319		Q	86000	8.89	.3500		
86000	7.52	.2961			86000	7.98	.3142			86000	8.44	.3323			86000	8.90	.3504		
86000	7.53	.2965			86000	7.99	.3146			86000	8.45	.3327			86000	8.91	.3508		
86000	7.54	.2969	19/64		86000	8.00	.3150			86000	8.46	.3331			86000	8.92	.3512		
86000	7.55	.2972			86000	8.01	.3154			86000	8.47	.3335			86000	8.93	.3516		
86000	7.56	.2976			86000	8.02	.3157			86000	8.48	.3339			86000	8.94	.3520		
86000	7.57	.2980			86000	8.03	.3161		O	86000	8.49	.3343			86000	8.95	.3524		
86000	7.58	.2984			86000	8.04	.3165			86000	8.50	.3346			86000	8.96	.3528		
86000	7.59	.2988			86000	8.05	.3169			86000	8.51	.3350			86000	8.97	.3531		
86000	7.60	.2992			86000	8.06	.3173			86000	8.52	.3354			86000	8.98	.3535		
86000	7.61	.2996			86000	8.07	.3177			86000	8.53	.3358			86000	8.99	.3539		
86000	7.62	.3000			86000	8.08	.3181			86000	8.54	.3362			86000	9.00	.3543		
86000	7.63	.3004			86000	8.09	.3185			86000	8.55	.3366			86000	9.01	.3547		
86000	7.64	.3008			86000	8.10	.3189			86000	8.56	.3370			86000	9.02	.3551		
86000	7.65	.3012			86000	8.11	.3193			86000	8.57	.3374			86000	9.03	.3555		
86000	7.66	.3016			86000	8.12	.3197			86000	8.58	.3378			86000	9.04	.3559		
86000	7.67	.3020		N	86000	8.13	.3201			86000	8.59	.3382			86000	9.05	.3563		
86000	7.68	.3024			86000	8.14	.3205			86000	8.60	.3386			86000	9.06	.3567		
86000	7.69	.3028			86000	8.15	.3209			86000	8.61	.3390		R	86000	9.07	.3571		

K15 CARBIDE — 6.5 - 7% Cobalt (0,006 - 0,008mm grain size)

EDP 8600					EDP 8600					EDP 8600					EDP 8600				
				SIZE					SIZE					SIZE					SIZE
#	mm	Decimal	inch	Wire	#	mm	Decimal	inch	Wire	#	mm	Decimal	inch	Wire	#	mm	Decimal	inch	Wire
86000	9.08	.3575			86000	9.20	.3622			86000	9.32	.3669			86000	9.44	.3717		
86000	9.09	.3579		T	86000	9.21	.3626			86000	9.33	.3673			86000	9.45	.3720		
86000	9.10	.3583			86000	9.22	.3630			86000	9.34	.3677			86000	9.46	.3724		
86000	9.11	.3587			86000	9.23	.3634			86000	9.35	.3681		U	86000	9.47	.3728		
86000	9.12	.3591			86000	9.24	.3638			86000	9.36	.3685			86000	9.48	.3732		
86000	9.13	.3594	23/64		86000	9.25	.3642			86000	9.37	.3689			86000	9.49	.3736		
86000	9.14	.3598			86000	9.26	.3646			86000	9.38	.3693			86000	9.50	.3740		
86000	9.15	.3602			86000	9.27	.3650			86000	9.39	.3697			86000	9.51	.3744		
86000	9.16	.3606			86000	9.28	.3654			86000	9.40	.3701			86000	9.52	.3748	3/8	
86000	9.17	.3610			86000	9.29	.3657			86000	9.41	.3705			86000	9.53	.3752		
86000	9.18	.3614			86000	9.30	.3661			86000	9.42	.3709			86000	9.54	.3756		
86000	9.19	.3618			86000	9.31	.3665			86000	9.43	.3713			86000	9.55	.3760		

REAMER FORMULAS FOR SPEEDS & FEEDS

The parameters below are based on using a carbide reamer at the highest SFM

MATERIAL	SPEED / SFM		Diameter mm	Diameter mm					
	CARBIDE	COBALT		2	4	6	10	15	20
Steel < 81 HRB	82-132	49-72	IPR	.006	.006	.006	.0098	.0098	.0118
			IPM	38.4	19.2	12.8	12.3	8.2	7.7
			RPM	6400	3200	2130	1300	850	640
Steel < 24 Rc.	66-82	39-56	IPR	.0039	.0039	.0047	.0071	.0071	.0098
			IPM	14.3	8.4	6.4	5.7	3.8	3.8
			RPM	4000	2000	1300	800	500	400
Steel 24-32 Rc.	39-59	25-33	IPR	.0031	.0031	.0039	.0071	.0059	.0087
			IPM	8.6	4.3	3.4	4.1	2.3	2.4
			RPM	2800	1430	1000	600	400	280
Steel 32-41 Rc.	33-49	16-23	IPR	.0031	.0031	.0035	.0059	.0079	.0098
			IPM	7.1	3.6	2.9	2.9	2.5	2.3
			RPM	2400	1200	800	500	300	240
Stainless Steel	23-39	10-16	IPR	.0028	.0028	.0039	.0047	.0059	.0079
			IPM	5.7	2.8	2.3	1.8	1.5	1.5
			RPM	1900	950	630	400	250	240
Inconel/Waspaloy	20-33	7-10	IPR	.0028	.0028	.0039	.0047	.0059	.0079
			IPM	4.8	2.4	1.9	1.5	1.3	1.2
			RPM	1600	800	540	320	200	200
Cast Iron ≤180 HB (Grey)	99-132	20-49	IPR	.0039	.0039	.0047	.0079	.0098	.0098
			IPM	23.1	11.5	10.2	10	8.2	6.1
			RPM	6400	3200	2130	1300	850	640
Cast Iron > 180 HB	26-49	13-16	IPR	.0028	.0028	.0039	.0059	.0071	.0079
			IPM	7.1	3.6	2.9	2.9	2.3	1.9
			RPM	2400	1200	800	480	300	240
Copper	82-99	39-66	IPR	.0047	.0047	.0071	.0079	.0098	.0118
			IPM	23.1	11.5	11.5	7.5	6.1	5.8
			RPM	4800	2400	1600	960	640	480
Brass	115-132	66-99	IPR	.0079	.0079	.0087	.0118	.0138	.0157
			IPM	50	25	17.9	15.4	11.8	10
			RPM	6400	3200	2130	1300	850	640
Bronze	66-82	39-56	IPR	.0059	.0059	.0071	.0087	.0138	.0146
			IPM	21.5	11.9	9.5	7.2	7.3	5.7
			RPM	4000	2000	1320	800	530	400
Aluminum	132-197	82-115	IPR	.0059	.0059	.0071	.0098	.0118	.0138
			IPM	57.3	28.7	22.9	18.3	15.3	13.2
			RPM	9500	4800	3200	1900	1300	950
Recommended drill hole diameter:				1,90	3,90	5,85	9,80	14,70	19,70

- SFM:** Surface Feet per Minute
- RPM:** Revolutions per Minute
- IPT:** Inches per Tooth (chip load)
- IPM:** Inches per Minute
- IPR:** Inches per Revolution

Speed Formula:
 $RPM = 3.82 \times (SFM \div \text{Diameter})$

Feed: $IPM = IPT \times \# \text{ of Flutes} \times RPM$
 $IPR = IPM \div RPM$
 $SFM = RPM \times \text{Diameter} \div 3.82$

Example: using a Carbide 2mm Reamer in Steel < 81 HRB
 $RPM = 3.82 \times (132 \div .0787) = 6407 \text{ RPM}$
 $IPM = .0015 \times 4 \times 6407 = 38.4 \text{ IPM}$
 $IPR = 38.4 \div 6407 = .0059 \text{ IPR}$

This chart has listed general reference parameters for a starting point.
 Below are a couple of tips for fine-tuning the desired size.

- To increase the hole diameter:** Slow down the feed rate and/or decrease RPM
- To decrease the hole diameter:** Increase the feed rate and/or increase the RPM

MICRO-MILLING

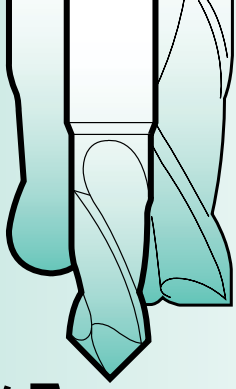

**New
2010!**

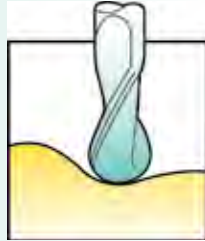

COPYING



PRECISE
GROOVING
R +/- 0,01mm

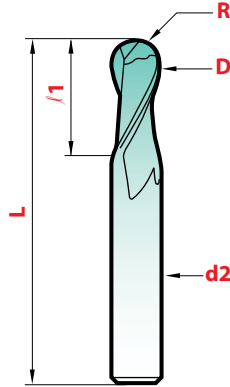

$$l = 1,5 \times D$$

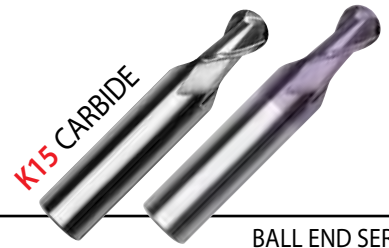

BALL END SERIES

inch	D mm	l	r	Magafor 8527	Hard'X 8527-H
.0039	0.10	.0039	.0020	85270010	
.0059	0.15	.0079	.0030	85270015	
.0079	0.20	.0118	.0039	85270020	
.0098	0.25	.0138	.0049	85270025	
.0118	0.30	.0177	.0059	85270030	8527H0030
.0157	0.40	.0236	.0079	85270040	8527H0040
.0197	0.50	.0295	.0098	85270050	8527H0050
.0236	0.60	.0354	.0118	85270060	8527H0060
.0276	0.70	.0413	.0138	85270070	8527H0070
.0315	0.80	.0472	.0157	85270080	8527H0080
.0354	0.90	.0531	.0177	85270090	8527H0090
.0394	1.00	.0591	.0197	85270100	8527H0100
.0472	1.20	.0709	.0236	85270120	8527H0120
.0591	1.50	.0886	.0295	85270150	8527H0150
.0787	2.00	.1181	.0394	85270200	8527H0200

$$l = 1,5 \times D$$



SQUARE END SERIES



PRECISE
GROOVING
0 - 0,01mm



FLAT BOTTOM
BORING

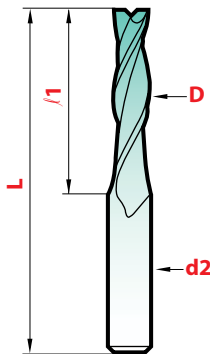

inch	D mm	l	Magafor 8507	Hard'X 8507-H
.0039	0.10	.0039	85070010	
.0059	0.15	.0079	85070015	
.0079	0.20	.0118	85070020	
.0098	0.25	.0138	85070025	
.0118	0.30	.0177	85070030	8507H0030
.0157	0.40	.0236	85070040	8507H0040
.0197	0.50	.0295	85070050	8507H0050
.0236	0.60	.0354	85070060	8507H0060
.0276	0.70	.0413	85070070	8507H0070
.0315	0.80	.0472	85070080	8507H0080
.0354	0.90	.0531	85070090	8507H0090
.0394	1.00	.0591	85070100	8507H0100
.0433	1.10	.0650	85070110	8507H0110
.0472	1.20	.0709	85070120	8507H0120
.0512	1.30	.0768	85070130	8507H0130
.0551	1.40	.0827	85070140	8507H0140
.0591	1.50	.0886	85070150	8507H0150
.0630	1.60	.0945	85070160	8507H0160
.0669	1.70	.1004	85070170	8507H0170
.0709	1.80	.1063	85070180	8507H0180
.0748	1.90	.1122	85070190	8507H0190
.0787	2.00	.1181	85070200	8507H0200

MINIATURE BALL-END END-MILLS WITH BACK CLEARANCE

$l = -1,5 \times D$

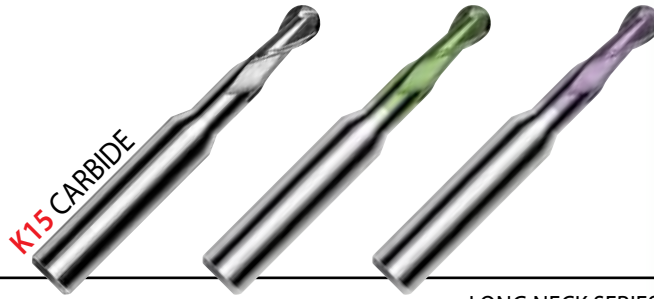

LONG NECK SERIES

Diameter x /2 inch mm	L	r1	R	Carbide 8527-D	K15/Graph'X 8527-DG	K15/Hard'X 8527-DH
.0157 x .078 0,4 x 2	1-1/2	.024	.0079	8527D0402	8527DG0402	8527DH0402
.0197 x .078 0,5 x 2	1-1/2	.027	.0098	8527D0502	8527DG0502	8527DH0502
.0197 x .157 0,5 x 4	1-1/2	.027	.0098	8527D0504	8527DG0504	8527DH0504
.0197 x .236 0,5 x 6	2-3/8	.027	.0098	8527D0506	8527DG0506	8527DH0506
.0236 x .157 0,6 x 4	1-1/2	.029	.0118	8527D0604	8527DG0604	8527DH0604
.0315 x .157 0,8 x 4	1-1/2	.041	.0158	8527D0804	8527DG0804	8527DH0804
.0315 x .236 0,8 x 6	1-1/2	.041	.0158	8527D0806	8527DG0806	8527DH0806
.0315 x .354 0,8 x 9	2-3/8	.041	.0158	8527D0809	8527DG0809	8527DH0809
.0394 x .157 1,0 x 4	1-1/2	.059	.0197	8527D1004	8527DG1004	8527DH1004
.0394 x .197 1,0 x 5	1-1/2	.059	.0197	8527D1005	8527DG1005	8527DH1005
.0394 x .236 1,0 x 6	1-1/2	.059	.0197	8527D1006	8527DG1006	8527DH1006
.0394 x .354 1,0 x 9	1-1/2	.059	.0197	8527D1009	8527DG1009	8527DH1009
.0394 x .472 1,0 x 12	2-3/8	.059	.0197	8527D1012	8527DG1012	8527DH1012
.0472 x .236 1,2 x 6	1-1/2	.071	.0236	8527D1206	8527DG1206	8527DH1206
.0551 x .276 1,4 x 7	1-3/4*	.083	.0276	8527D1407	8527DG1407	8527DH1407
.0591 x .236 1,5 x 6	1-1/2	.089	.0295	8527D1506	8527DG1506	8527DH1506
.0591 x .295 1,5 x 7,5	1-3/4*	.089	.0295	8527D1575	8527DG1575	8527DH1575
.0591 x .354 1,5 x 9	1-1/2	.089	.0295	8527D1509	8527DG1509	8527DH1509
.0591 x .472 1,5 x 12	2-3/8	.089	.0295	8527D1512	8527DG1512	8527DH1512
.0630 x .315 1,6 x 8	1-3/4*	.094	.0315	8527D1608	8527DG1608	8527DH1608
.0709 x .354 1,8 x 9	1-3/4*	.106	.0354	8527D1809	8527DG1809	8527DH1809
.0787 x .354 2,0 x 9	1-1/2	.118	.0394	8527D2009	8527DG2009	8527DH2009
.0787 x .394 2,0 x 10	1-3/4*	.118	.0394	8527D2010	8527DG2010	8527DH2010
.0787 x .472 2,0 x 12	1-1/2	.118	.0394	8527D2012	8527DG2012	8527DH2012
.0787 x .590 2,0 x 15	2-3/8	.118	.0394	8527D2015	8527DG2015	8527DH2015
.0984 x .472 2,5 x 12	1-3/4*	.148	.0492	8527D2512	8527DG2512	8527DH2512
.0984 x .590 2,5 x 15	2-3/8	.148	.0492	8527D2515	8527DG2515	8527DH2515
.1181 x .590 3,0 x 15	1-3/4*	.177	.0590	8527D3015	8527DG3015	8527DH3015

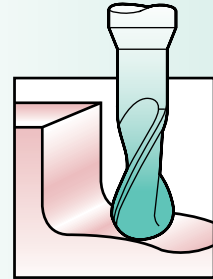

MACHININGS
HARD TO REACH

PRECISION R ± .0004

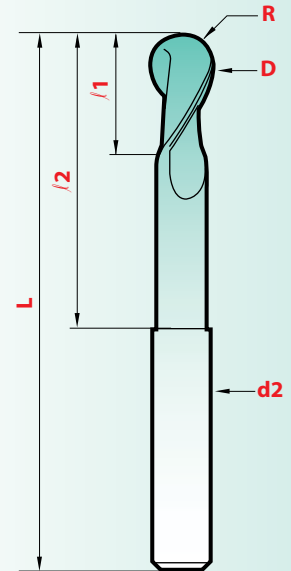

All shanks are .118 / 3 mm K15 CARBIDE — 6.5 - 7% Cobalt (0,006 - 0,008mm grain size)
* are .157 / 4 mm diameter

MINIATURE END MILLS Speeds & Feeds

Material	Diameter(mm)	SFM	RPM	Inch/tooth	IPM
Steels 24-40Rc	0,5	132	25615	.00004	2.0
	1	132	12808	.0001	2.5
	1,5	132	8538	.0001	1.7
	2	132	6404	.0002	2.5
	3	132	4270	.0002	1.7
Steel 41Rc- 45Rc	0,5	82	15920	.00004	1.3
	1	82	7960	.0001	1.6
	1,5	82	5310	.0001	1.1
	2	82	3980	.0002	1.6
3	82	2650	.0002	1.1	
Steels >45Rc TiAlN coated tools only	0,5	132	25615	.00004	2.0
	1	132	12808	.0001	2.5
	1,5	132	8538	.0001	1.7
	2	132	6404	.0002	2.5
	3	132	4270	.0002	1.7
Plastics with glass or carbon filters	0,5	263	51040	.00004	4.1
	1	263	25520	.0002	10.2
	1,5	263	17010	.0006	20.4
	2	263	12760	.0008	20.4
	3	263	8500	.0012	20.4
Aluminum and other plastics	0,5	494	95860	.0002	38.3
	1	658	63840	.0005	63.8
	1,5	658	42560	.0007	60.0
	2	658	31920	.0009	57.5
3	658	21280	.0014	60.0	
Copper Brass Bronze and Steels <24 Rc	0,5	263	51000	.0002	20.4
	1	263	25520	.0005	25.5
	1,5	263	17000	.0007	24.0
	2	263	12750	.0009	23.0
	3	263	8500	.0014	24.0

MINIATURE END-MILLS WITH BACK CLEARANCE

$$l = 1,5 \times D$$

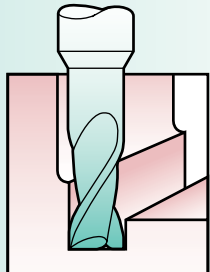
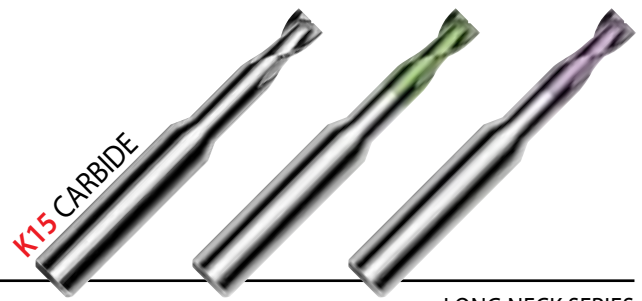

HARD TO REACH MACHINING

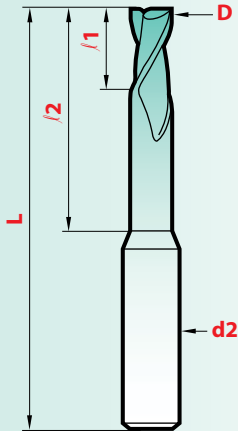

d2 = .118 / 3 mm

LONG NECK SERIES

Diameter x l/2		l/1	L	magaforce	K15/Graph'X	k15/Hard'X
inch	mm			8507-D	8507-DG	8507-DH
.0157 x .078	0,4 x 2	.024	1-1/2	8507D0402	8507DG0402	8507DH0402
.0197 x .078	0,5 x 2	.027	1-1/2	8507D0502	8507DG0502	8507DH0502
.0197 x .157	0,5 x 4	.027	1-1/2	8507D0504	8507DG0504	8507DH0504
.0197 x .236	0,5 x 6	.027	2-3/8	8507D0506	8507DG0506	8507DH0506
.0236 x .157	0,6 x 4	.029	1-1/2	8507D0604	8507DG0604	8507DH0604
.0276 x .157	0,7 x 4	.035	1-1/2	8507D0704	8507DG0704	8507DH0704
.0315 x .157	0,8 x 4	.041	1-1/2	8507D0804	8507DG0804	8507DH0804
.0315 x .236	0,8 x 6	.041	1-1/2	8507D0806	8507DG0806	8507DH0806
.0315 x .354	0,8 x 9	.041	2-3/8	8507D0809	8507DG0809	8507DH0809
.0354 x .236	0,9 x 6	.053	1-1/2	8507D0906	8507DG0906	8507DH0906
.0394 x .157	1,0 x 4	.059	1-1/2	8507D1004	8507DG1004	8507DH1004
.0394 x .236	1,0 x 6	.059	1-1/2	8507D1006	8507DG1006	8507DH1006
.0394 x .354	1,0 x 9	.059	1-1/2	8507D1009	8507DG1009	8507DH1009
.0394 x .472	1,0 x 12	.059	2-3/8	8507D1012	8507DG1012	8507DH1012
.0472 x .236	1,2 x 6	.071	1-1/2	8507D1206	8507DG1206	8507DH1206
.0472 x .354	1,2 x 9	.071	1-1/2	8507D1209	8507DG1209	8507DH1209
.0551 x .236	1,4 x 6	.083	1-1/2	8507D1406	8507DG1406	8507DH1406
.0551 x .354	1,4 x 9	.083	1-1/2	8507D1409	8507DG1409	8507DH1409
.0591 x .236	1,5 x 6	.089	1-1/2	8507D1506	8507DG1506	8507DH1506
.0591 x .354	1,5 x 9	.089	1-1/2	8507D1509	8507DG1509	8507DH1509
.0591 x .472	1,5 x 12	.089	2-3/8	8507D1512	8507DG1512	8507DH1512
.0709 x .354	1,8 x 9	.106	1-1/2	8507D1809	8507DG1809	8507DH1809
.0709 x .472	1,8 x 12	.106	1-1/2	8507D1812	8507DG1812	8507DH1812
.0787 x .354	2,0 x 9	.118	1-1/2	8507D2009	8507DG2009	8507DH2009
.0787 x .472	2,0 x 12	.118	1-1/2	8507D2012	8507DG2012	8507DH2012
.0787 x .590	2,0 x 15	.118	2-3/8	8507D2015	8507DG2015	8507DH2015
.0984 x .590	2,5 x 15	.148	2-3/8	8507D2515	8507DG2515	8507DH2515

l/2: tolerance - .0008 - .0020
*Call for pricing

MINIATURE END MILLS *Speeds & Feeds*

Material	Diameter(mm)	SFM	RPM	Inch/tooth	IPM	Material	Diameter(mm)	SFM	RPM	Inch/tooth	IPM
Steels 24-40Rc	0,5	132	25615	.00004	2.0	Plastics with glass or carbon filters	0,5	263	51040	.00004	4.1
	1	132	12808	.0001	2.5		1	263	25520	.0002	10.2
	1,5	132	8538	.0001	1.7		1,5	263	17010	.0006	20.4
	2	132	6404	.0002	2.5		2	263	12760	.0008	20.4
Steel 41Rc- 45Rc	3	132	4270	.0002	1.7	3	263	8500	.0012	20.4	
	0,5	82	15920	.00004	1.3	0,5	494	95860	.0002	38.3	
	1	82	7960	.0001	1.6	Aluminum and other plastics	1	658	63840	.0005	63.8
	1,5	82	5310	.0001	1.1	1,5	658	42560	.0007	60.0	
Steels >45Rc TiAlN coated tools only	2	82	3980	.0002	1.6	2	658	31920	.0009	57.5	
	3	82	2650	.0002	1.1	3	658	21280	.0014	60.0	
	0,5	132	25615	.00004	2.0	Copper Brass Bronze and Steels <24 Rc	0,5	263	51000	.0002	20.4
1	132	12808	.0001	2.5	1	263	25520	.0005	25.5		
1,5	132	8538	.0001	1.7	1,5	263	17000	.0007	24.0		
2	132	6404	.0002	2.5	2	263	12750	.0009	23.0		
3	132	4270	.0002	1.7	3	263	8500	.0014	24.0		

MINIATURE BALL-END END-MILLS

$l \approx 2-3 \times D$



K15 CARBIDE



STANDARD SERIES

Diameter		ℓ1	R	magaforce 8529	K15/Graph'X 8529-G	K15/Hard'X 8529-H
inch	mm					
.0039	0,1	.008	.0020	85290010		
.0059	0,15	.012	.0030	85290015		
.0079	0,2	.020	.0040	85290020		
.0098	0,25	.020	.0049	85290025		
.0118	0,3	.040	.0059	85290030	85290030-G	85290030-H
.0138	0,35	.040	.0069	85290035		85290035-H
.0157	0,4	.040	.0079	85290040	85290040-G	85290040-H
.0197	0,5	.060	.0098	85290050	85290050-G	85290050-H
.0236	0,6	.060	.0118	85290060	85290060-G	85290060-H
.0276	0,7	.080	.0138	85290070	85290070-G	85290070-H
.0315	0,8	.080	.0158	85290080	85290080-G	85290080-H
.0354	0,9	.100	.0177	85290090	85290090-G	85290090-H
.0394	1,0	.120	.0197	85290100	85290100-G	85290100-H
.0433	1,1	.120	.0217	85290110	85290110-G	85290110-H
.0472	1,2	.160	.0236	85290120	85290120-G	85290120-H
.0551	1,4	.160	.0276	85290140	85290140-G	85290140-H
.0591	1,5	.160	.0295	85290150	85290150-G	85290150-H
.0630	1,6	.160	.0315	85290160	85290160-G	85290160-H
.0709	1,8	.200	.0354	85290180	85290180-G	85290180-H
.0787	2,0	.200	.0394	85290200	85290200-G	85290200-H
.0984	2,5	.275	.0492	85290250	85290250-G	85290250-H
.1181	3,0	.400	.0590	85290300	85290300-G	85290300-H
.1378	3,5	.400	.0689	85290350	85290350-G	85290350-H
.1575	4,0	.475	.0787	85290400	85290400-G	85290400-H
.1772	4,5	.475	.0886	85290450	85290450-G	85290450-H
.1968	5,0	.550	.0984	85290500	85290500-G	85290500-H
.2165	5,5	.550	.1083	85290550	85290550-G	85290550-H

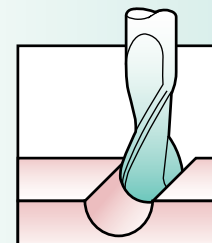

SLOTING
ENGRAVING

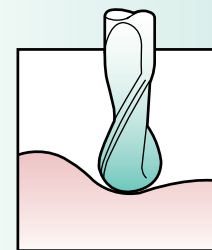

MOLD SHAPING

PRECISION $R \pm .0004$

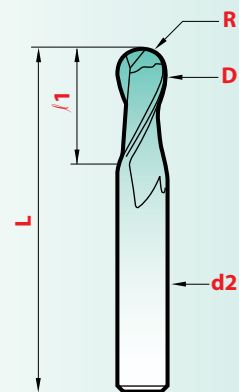

D	d2	L
.0039 to .0984	.118	1-1/2
.1181 to .1378	.157	1-3/4
.1575 to .1772	.197	2
.1968 to .2165	.236	2

Tolerances

STANDARD LENGTH MINIATURE END-MILLS

TOLERANCE 0 - .0004"

$l \approx 2-3 \times D$

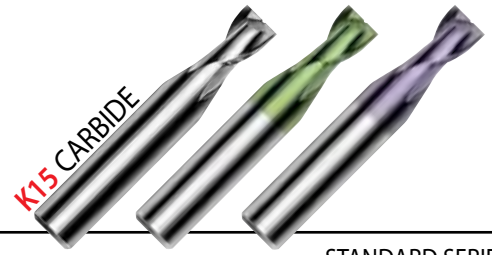

STANDARD SERIES

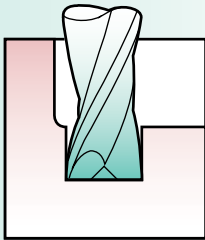

SLOTING
ENGRAVING

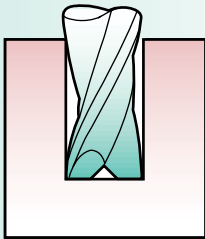

FLAT BOTTOM
BORING

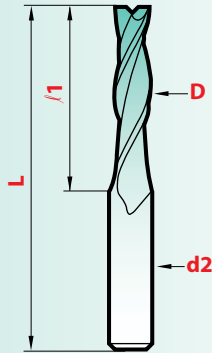

Diameter		r_1	L	d2	magaforce	Graph'X	Hard'X
inch	mm				8500	8500-G	8500-H
.0020	0,05	.004	1-1/2	.118 3 mm	85000005		
.0024	0,06	.005			85000006		
.0031	0,08	.006			85000008		
.0039	0,10	.008			85000010		
.0047	0,12	.009			85000012		
.0059	0,15	.012			85000015		
.0079	0,20	.020			85000020		
.0098	0,25	.020			85000025		
.0118	0,30	.039			85000030	85000030-G	85000030-H
.0138	0,35	.039			85000035	85000035-G	85000035-H
.0157	0,40	.039			85000040	85000040-G	85000040-H
.0177	0,45	.039			85000045	85000045-G	85000045-H
.0197	0,50	.059			85000050	85000050-G	85000050-H
.0216	0,55	.059			85000055	85000055-G	85000055-H
.0236	0,60	.059			85000060	85000060-G	85000060-H
.0256	0,65	.059			85000065	85000065-G	85000065-H
.0276	0,70	.079			85000070	85000070-G	85000070-H
.0295	0,75	.079			85000075	85000075-G	85000075-H
.0315	0,80	.079			85000080	85000080-G	85000080-H
.0335	0,85	.079			85000085	85000085-G	85000085-H
.0354	0,90	.098			85000090	85000090-G	85000090-H
.0374	0,95	.098			85000095	85000095-G	85000095-H
.0394	1,00	0.12	85000100	85000100-G	85000100-H		
.0413	1,05	0.12	85000105	85000105-G	85000105-H		
.0433	1,10	0.12	85000110	85000110-G	85000110-H		
.0452	1,15	0.12	85000115	85000115-G	85000115-H		
.0472	1,20	0.16	85000120	85000120-G	85000120-H		
.0492	1,25	0.16	85000125	85000125-G	85000125-H		
.0512	1,30	0.16	85000130	85000130-G	85000130-H		
.0551	1,40	0.16	85000140	85000140-G	85000140-H		
.0591	1,50	0.16	85000150	85000150-G	85000150-H		
.0630	1,60	0.20	85000160	85000160-G	85000160-H		
.0669	1,70	0.20	85000170	85000170-G	85000170-H		
.0709	1,80	0.20	85000180	85000180-G	85000180-H		
.0748	1,90	0.20	85000190	85000190-G	85000190-H		
.0787	2,00	0.20	85000200	85000200-G	85000200-H		
.0827	2,10	0.24	85000210	85000210-G	85000210-H		
.0866	2,20	0.24	85000220	85000220-G	85000220-H		

K15 CARBIDE — 6.5 - 7% Cobalt (0,006 - 0,008mm grain size)

STANDARD LENGTH MINIATURE END-MILLS

$l \approx 2-3 \times D$

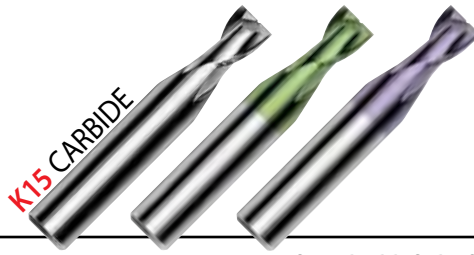

STANDARD SERIES

Diameter inch mm	λ_1	L	d2	magaforce 8500	Graph'X 8500-G	Hard'X 8500-H		
.0906 2,30	0.24	1-1/2	.118 3 mm	85000230	85000230-G	8500230-H		
.0945 2,40	0.24			85000240	85000240-G	8500240-H		
.0984 2,50	0.28			85000250	85000250-G	8500250-H		
.1024 2,60	0.28			85000260	85000260-G	8500260-H		
.1063 2,70	0.28			85000270	85000270-G	8500270-H		
.1102 2,80	0.28			85000280	85000280-G	8500280-H		
.1142 2,90	0.28			85000290	85000290-G	8500290-H		
.1181 3,00	0.39			1-3/4	.157 4 mm	85000300	85000300-G	8500300-H
.1220 3,10	0.39					85000310	85000310-G	8500310-H
.1260 3,20	0.39					85000320	85000320-G	8500320-H
.1299 3,30	0.39	85000330	85000330-G			8500330-H		
.1339 3,40	0.39	85000340	85000340-G			8500340-H		
.1378 3,50	0.39	85000350	85000350-G			8500350-H		
.1417 3,60	0.39	85000360	85000360-G			8500360-H		
.1457 3,70	0.39	85000370	85000370-G			8500370-H		
.1496 3,80	0.39	85000380	85000380-G			8500380-H		
.1535 3,90	0.39	85000390	85000390-G			8500390-H		

STANDARD SERIES

Diameter inch mm	λ_1	L	d2	magaforce 8500	Graph'X 8500-G	Hard'X 8500-H
.1575 4,00	0.47	2-3/16	.197 5 mm	85000400	85000400-G	85000400-H
.1614 4,10	0.47			85000410	85000410-G	85000410-H
.1654 4,20	0.47			85000420	85000420-G	85000420-H
.1693 4,30	0.47			85000430	85000430-G	85000430-H
.1732 4,40	0.47			85000440	85000440-G	85000440-H
.1772 4,50	0.47			85000450	85000450-G	85000450-H
.1811 4,60	0.47			85000460	85000460-G	85000460-H
.1850 4,70	0.47			85000470	85000470-G	85000470-H
.1890 4,80	0.47			85000480	85000480-G	85000480-H
.1929 4,90	0.47			85000490	85000490-G	85000490-H
.1969 5,00	0.55	2-3/16	.236 6 mm	85000500	85000500-G	85000500-H
.2008 5,10	0.55			85000510	85000510-G	85000510-H
.2047 5,20	0.55			85000520	85000520-G	85000520-H
.2087 5,30	0.55			85000530	85000530-G	85000530-H
.2126 5,40	0.55			85000540	85000540-G	85000540-H
.2165 5,50	0.55			85000550	85000550-G	85000550-H
.2205 5,60	0.55			85000560	85000560-G	85000560-H
.2244 5,70	0.55			85000570	85000570-G	85000570-H
.2283 5,80	0.55			85000580	85000580-G	85000580-H
.2323 5,90	0.55			85000590	85000590-G	85000590-H

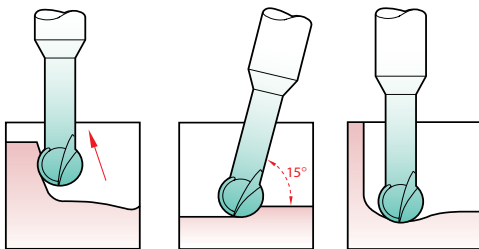

$l_2 = 5 \times D$

K15 CARBIDE

LONG NECK SERIES

Diameter		d1	d2	L	λ_1	λ_2	R	Hard'X 8522-H
inch	mm							
.0315	0,8	0,70	3	60	0,55	4,0	0,4	8522H08
.0394	1,0	0,85	3	60	0,70	5,0	0,5	8522H10
.0472	1,2	1,00	3	60	0,80	6,0	0,6	8522H12
.0590	1,5	1,30	3	60	1,00	7,5	0,75	8522H15
.0787	2,0	1,70	3	60	1,35	10,0	1,0	8522H20
.1180	3,0	2,60	6	75	2,00	15,0	1,5	8522H30
.1575	4,0	3,45	6	75	2,70	20,0	2,0	8522H40
.1969	5,0	4,30	6	75	3,40	25,0	2,5	8522H50

220° ball-end
MINIATURE
END-MILLS
with back clearance

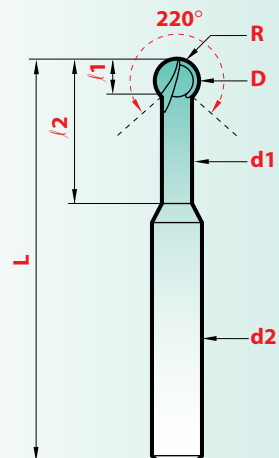

*Call for pricing

LONG MINIATURE END-MILLS

TOLERANCE 0 - .0004"

$l = 5 \times D$

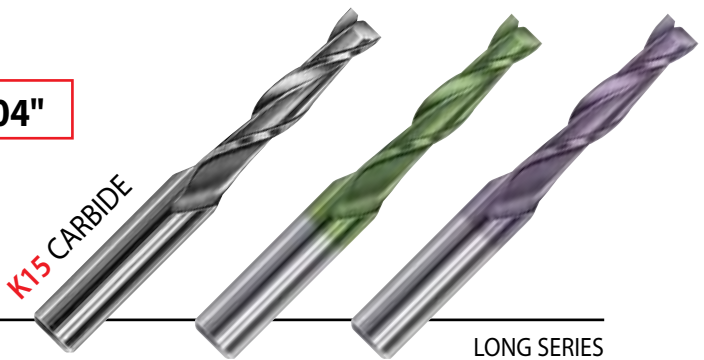
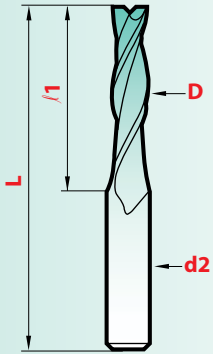

L = 1-1/2 d2 = .118 / 3 mm LONG SERIES

Diameter		f1	magaforce 8509	Graph'X 8509-G	Hard'X 8509-H
inch	mm				
.0157	0,4	.078	850904	850904-G	850904-H
.0197	0,5	.098	850905	850905-G	850905-H
.0236	0,6	.118	850906	850906-G	850906-H
.0276	0,7	.137	850907	850907-G	850907-H
.0315	0,8	.157	850908	850908-G	850908-H
.0354	0,9	.177	850909	850909-G	850909-H
.0394	1,0	.197	850910	850910-G	850910-H
.0472	1,2	.236	850912	850912-G	850912-H
.0591	1,5	.295	850915	850915-G	850915-H
.0787	2,0	.394	850920	850920-G	850920-H

*Call for pricing

EXTRA-LONG MINIATURE END-MILLS

TOLERANCE 0 - .0004"

$l = 8 \times D$

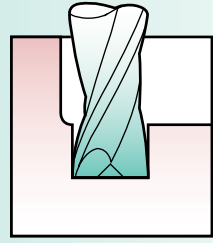

SLOTING ENGRAVING

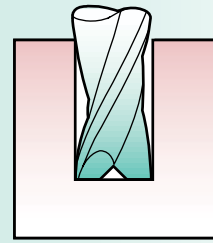

FLAT BOTTOM BORING

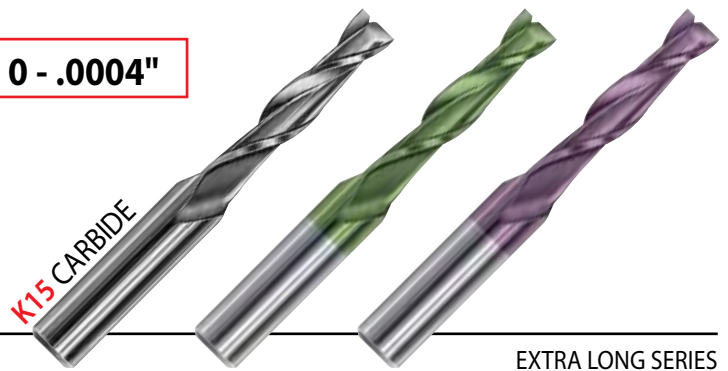

EXTRA LONG SERIES

Diameter		f1	L	d2	magaforce 8510	Graph'X 8510-G	Hard'X 8510-H
inch	mm						
.0197	0,5	.157	1-1/2	.118 3 mm	851005	851005-G	851005-H
.0236	0,6	.197			851006	851006-G	851006-H
.0315	0,8	.236			851008	851008-G	851008-H
.0394	1,0	.315			851010	851010-G	851010-H
.0472	1,2	.354	1-3/4	.157 4 mm	851012	851012-G	851012-H
.0591	1,5	.472			851015	851015-G	851015-H
.0787	2,0	.630			851020	851020-G	851020-H
.0984	2,5	.788	2-3/8	.197 5 mm	851025	851025-G	851025-H
.1181	3,0	.945			851030	851030-G	851030-H

*Call for pricing

The radius is positioned in relation to the small $\varnothing d1$:-
so it is possible to machine compound forms,
small slots and holes from 0,5 mm.

CARBIDE MINIATURE CORNER ROUNDING END-MILLS

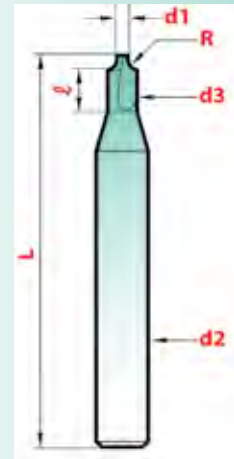
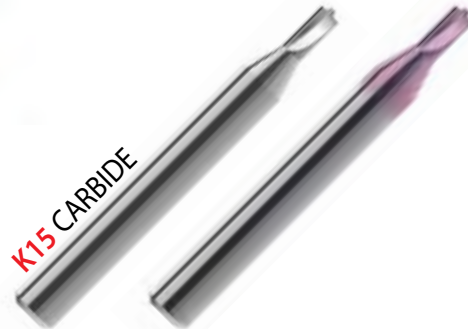
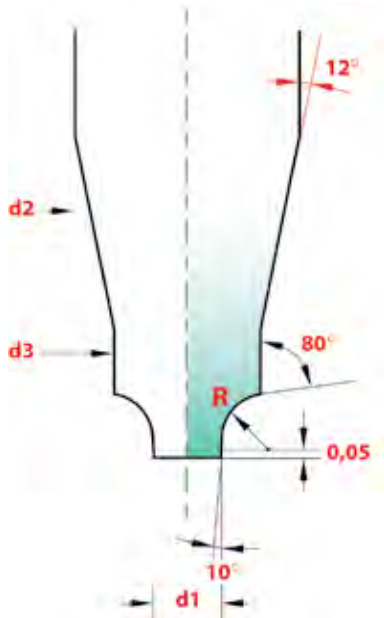

Radius		d1	d2	d3	λ	L	Carbide 8550	Hard'X 8550-H
Inch	mm							
.0039	0,10	.020	.118	.031	.098	2	85500010	8550H010
.0059	0,15	.020	.118	.035	.098	2	85500015	8550H015
.0079	0,20	.020	.118	.040	.098	2	85500020	8550H020
.0098	0,25	.020	.118	.040	.098	2	85500025	8550H025
.0118	0,30	.020	.118	.047	.098	2	85500030	8550H030
.0157	0,40	.020	.118	.055	.098	2	85500040	8550H040
.0197	0,50	.020	.118	.063	.098	2	85500050	8550H050
.0236	0,60	.020	.118	.071	.118	2	85500060	8550H060
.0276	0,70	.020	.118	.083	.118	2	85500070	8550H070
.0295	0,75	.020	.118	.083	.118	2	85500075	8550H075
.0315	0,80	.031	.118	.098	.157	2	85500080	8550H080
.0354	0,90	.031	.118	.114	.157	2	85500090	8550H090
.0394	1,00	.031	.118	.114	.157	2	85500100	8550H100
.0492	1,25	.031	.157	.134	.157	2	85500125	8550H125
.0591	1,50	.059	.197	.181	.236	2	85500150	8550H150
.0689	1,75	.059	.236	.220	.236	2	85500175	8550H175
.0787	2,00	.059	.236	.220	.315	2	85500200	8550H200
.0886	2,25	.059	.315	.260	.394	2	85500225	8550H225
.0984	2,50	.059	.315	.260	.394	2	85500250	8550H250
.1181	3,00	.059	.315	.299	.394	2	85500300	8550H300
.1575	4,00	.075	.394	.394	-	2-3/16	85500400	8550H400
.1969	5,00	.075	.472	.472	-	2-1/2	85500500	8550H500

Coating is available

Tolerances

R	d1	d2	L
± .0008	± .00039	h6	± .0040

These cutters are designed
for CNC machine.
They allow machining
even very thin materials.
Many easy regrinds.

MINIATURE MILLING: RECOMMENDATIONS OF USING

- Endmills with long neck, extra long neck, and deep machining: reduce the speed, while maintaining the suggested feed.
- Superficial work: increase the speed, while maintaining the suggested feed.

MINIATURE END MILLS *Speeds & Feeds*

Material	Diameter(mm)	SFM	RPM	Inch/tooth	IPM
Steels 24-40Rc	0.5	132	25615	.00004	2.0
	1	132	12808	.0001	2.5
	1.5	132	8538	.0001	1.7
	2	132	6404	.0002	2.5
	3	132	4270	.0002	1.7
Steel 41Rc- 45Rc	0.5	82	15920	.00004	1.3
	1	82	7960	.0001	1.6
	1.5	82	5310	.0001	1.1
	2	82	3980	.0002	1.6
	3	82	2650	.0002	1.1
Steels >45Rc TiAlN coated tools only	0.5	132	25615	.00004	2.0
	1	132	12808	.0001	2.5
	1.5	132	8538	.0001	1.7
	2	132	6404	.0002	2.5
	3	132	4270	.0002	1.7
Plastics with glass or carbon filters	0.5	263	51040	.00004	4.1
	1	263	25520	.0002	10.2
	1.5	263	17010	.0006	20.4
	2	263	12760	.0008	20.4
	3	263	8500	.0012	20.4
	0.5	494	95860	.0002	38.3
	1	658	63840	.0005	63.8
	1.5	658	42560	.0007	60.0
	2	658	31920	.0009	57.5
	3	658	21280	.0014	60.0
Aluminum and other plastics	0.5	263	51000	.0002	20.4
	1	263	25520	.0005	25.5
	1.5	263	17000	.0007	24.0
	2	263	12750	.0009	23.0
	3	263	8500	.0014	24.0
Copper and Steels <24 Rc	0.5	263	51000	.0002	20.4
	1	263	25520	.0005	25.5

This chart has listed general reference parameters for a starting point.

- SFM:** Surface Feet per Minute
- RPM:** Revolutions per Minute
- IPT:** Inches per Tooth (chip load)
- IPM:** Inches per Minute
- IPR:** Inches per Revolution

Speed Formula:
 $RPM = 3.82 \times (SFM \div Diameter)$

Feed: $IPM = IPT \times \# \text{ of Flutes} \times RPM$
 $IPR = IPM \div RPM$
 $SFM = RPM \times Diameter \div 3.82$

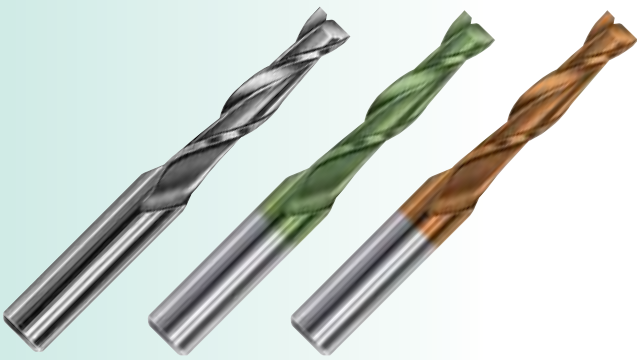

"Special"

Our stock of semi-finished tools offers the advantage to manufacture many specials. With your inquiries, please fill out the appropriate sketch to your centering operation.

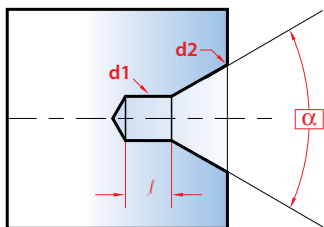
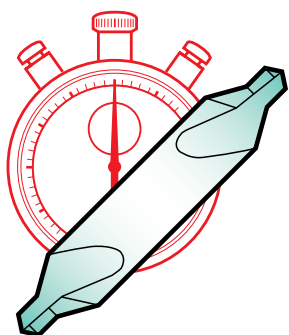

d1 = l =
d2 = alpha =

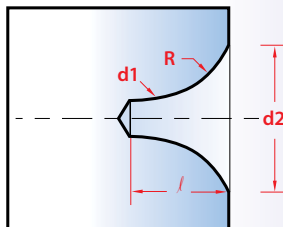

d1 = R =
d2 = l =

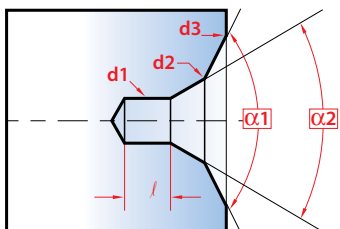

d1 = l =
d2 = alpha1 =
d3 = alpha2 =

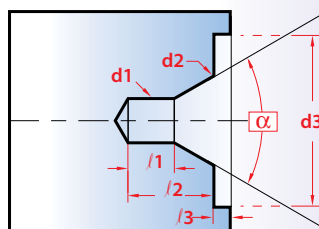

d1 = l1 =
d2 = l2 =
d3 = l3 =
alpha =

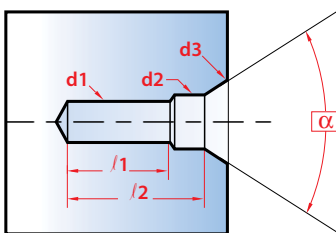
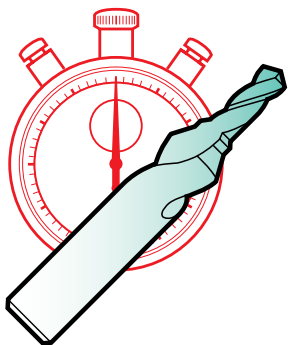

d1 = l1 =
d2 = l2 =
d3 = alpha =

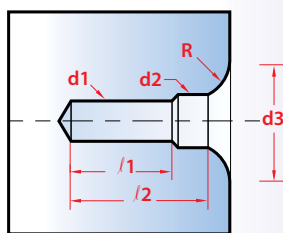

d1 = R =
d2 = l1 =
d3 = l2 =

- 1 Material to bore _____
- 2 Number of tools _____
- 3 Special tolerance _____

Name and address

SPECIAL REAMERS *Please fill out the following form :*

1 HOLE

Blind

Through

Number of holes _____

2 UTILIZATION

Hand

Machine

Straight shank

Morse taper shank

3 CONDITIONS

Material to bore

Material hardness

Drilling \emptyset

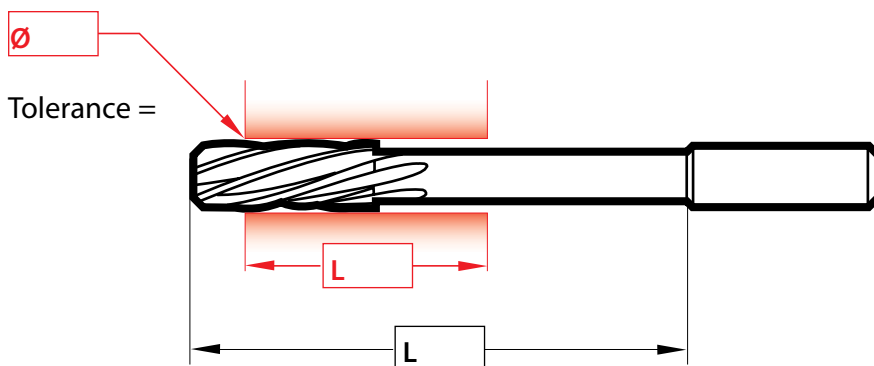

Name and address



Send to:

magafor

10 Industrial Boulevard
Turners Falls, MA 01376 USA
TEL : (413) 863-9052 • FAX : (413) 863-9058
TOLL FREE : 1-800-665-6734
TOLL FREE FAX : 1-866-308-7471
e-mail : info@magaforusa.com
www.magaforusa.com