

## Module 4x4 SK taper alignment adaptor

### Product information

- ISO taper to DIN ISO 7388-1 form AD/B
- for highly accurate alignment of all modular flanges 4x4
- cooling lubricant without loss and flow-disruption thanks to the use of an intermediate tube
- suitable for MQL and conventional cooling
- balancing quality G6.3 / 15,000 rev./min
- 6 balancing threads M6
- SK40 - M16 x 2.0 retention knob
- SK50 - M24 x 3.0 retention knob

### Scope of delivery

- incl. 4 screws for radial adjustment
- incl. 4 clamping screws
- order intermediate tube Series no. 4716 separately

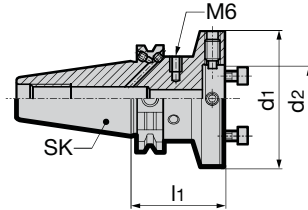

Series no. **4724**

SK	d <sub>1</sub> mm	d <sub>2</sub> mm	l <sub>1</sub> mm	Code no.	EDP Number
40	60	30	50	60.040	9047240600400
40	70	35	50	70.040	9047240700400
40	80	40	55	80.040	9047240800400
40	100	50	60	100.040	9047241000400
50	60	30	50	60.050	9047240600500
50	70	35	50	70.050	9047240700500
50	80	40	50	80.050	9047240800500
50	100	50	60	100.050	9047241000500
50	117	50	60	117.050	9047241170500
50	140	80	60	140.050	9047241400500

## Module 4x4 taper alignment adaptor BT

### Product information

- MAS/BT to DIN ISO 7388-2 form AD
- for highly accurate alignment of all modular flanges 4x4
- cooling lubricant without loss and flow-disruption thanks to the use of an intermediate tube
- suitable for MQL and conventional cooling
- balancing quality G6.3 / 15,000 rev./min
- 6 balancing threads M6
- BT30 - M12 x 1.75 retention knob
- BT40 - M16 x 2.0 retention knob
- BT50 - M24 x 3.0 retention knob

### Scope of delivery

- incl. 4 screws for radial adjustment
- incl. 4 clamping screws
- incl. set screws

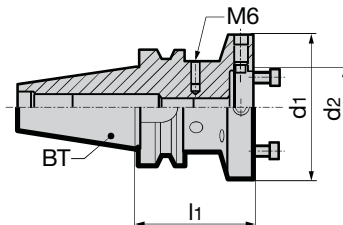

Series no. **4709**

BT	d <sub>1</sub> mm	d <sub>2</sub> mm	l <sub>1</sub> mm	Code no.	EDP Number
30	60	30	50	60.030	9047090600300
30	70	35	50	70.030	9047090700300
40	60	30	55	60.040	9047090600400
40	70	35	55	70.040	9047090700400
40	80	40	65	80.040	9047090800400
40	100	50	70	100.040	9047091000400
50	60	30	70	60.050	9047090600500
50	70	35	70	70.050	9047090700500
50	80	40	70	80.050	9047090800500
50	100	50	70	100.050	9047091000500
50	117	60	80	117.050	9047091170500
50	140	80	80	140.050	9047091400500

**4949**

Coolant supply set HSK-A (conventional)



**4939** 

MQL 1-channel coolant supply set HSK-A



**4940** 

MQL 1-channel coolant supply set HSK-A (filler)



**4797**

Module HSK-A alignment adaptor



**4724**

Module SK taper alignment adaptor



**4709**

Module taper alignment adaptor BT



machine spindle direct installation



Intermediate sleeve



**4716**

Intermediate sleeve



**4713**

Module HSK adaptor flange



**4360**

Module hydraulic chuck flange



**4760**

Module shrink fit chuck flange



HOLDERS FOR FINE MACHINING

**Product information**

- for the highly accurate alignment of all modular flanges 4x4
- cooling lubricant without loss and flow-disruption thanks to the use of an intermediate tube
- suitable for MQL and conventional cooling
- balancing quality G6.3 / 15,000 rev./min
- 6 balancing threads M6
- HSK-A to ISO 12164-1/DIN 69893-1

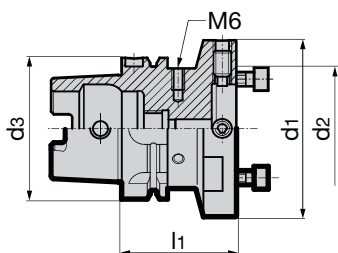

**Scope of delivery**

- incl. 4 screws for radial adjustment
- incl. 4 clamping screws
- order coolant supply set Series no. 4949, MQL coolant supply set Series no. 4939 or 4940 separately
- order intermediate tube Series no. 4716 separately
- further dimensions on request



		Series no.		4297		
HSK-A	d <sub>3</sub>	d <sub>1</sub>	d <sub>2</sub>	l <sub>1</sub>	Code no.	EDP Number
mm	mm	mm	mm	mm		
63	60	30	60	60	60.063	9042970600630
63	70	35	60	60	70.063	9042970700630
63	80	40	60	60	80.063	9042970800630
63	100	50	65	65	100.063	9042971000630
63	117	60	65	65	117.063	9042971170630
80	70	35	60	60	70.080	9042970700800
80	80	40	60	60	80.080	9042970800800
80	100	50	65	65	100.080	9042971000800
80	117	60	65	65	117.080	9042971170800
80	140	80	75	75	140.080	9042971400800
100	70	35	55	55	70.100	9042970701000
100	80	40	55	55	80.100	9042970801000
100	100	50	65	65	100.100	9042971001000
100	117	60	65	65	117.100	9042971171000
100	140	80	75	75	140.100	9042971401000

Holders for fine machining

## Module 4x4 hydraulic chuck flange

### Product information

- for the highly accurate radial and axial alignment on alignment adaptors or machine spindles
- cooling lubricant without loss and flow-disruption thanks to the use of an intermediate tube
- balancing quality G6.3 / 15,000 rev./min
- for tool shank tolerance h6

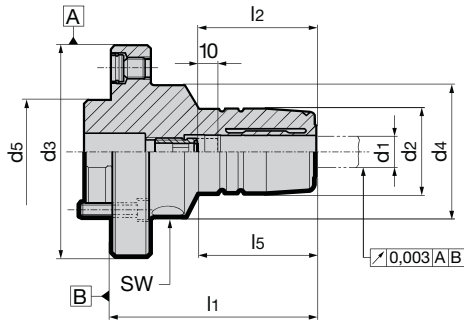

### Scope of delivery

- incl. adjustment screw Series no. 4941 for conventional cooling
- incl. angular alignment set Series no. 4715
- incl. 4 clamping screws
- incl. hexagon chuck key Series no. 4912
- order intermediate tube Series no. 4716 separately
- for other clamping  $\varnothing$  apply reduction bushes Series no. 4368 or 4369
- MQL version on request



Series no. **4360**

Module- $\varnothing$ d3 mm	for shank $\varnothing$ d1 h6 mm	d2 mm	d4 mm	d5 mm	l1 mm	l2 mm	l5 mm	incl. setting screw art. no. 4941	intermediate sleeve tube art. no. 4716	SW	Code no.	EDP Number
70	12	32	40	35	75.0	45	45.0	12.100	14.020	4	12.070	9043600120700
80	12	32	50	40	77.5	45	44.3	12.100	14.050	5	12.080	9043600120800
80	20	42	50	40	82.5	50	51.5	20.100	14.040	5	20.080	9043600200800
100	32	64	64	50	103.0	60	84.0	32.100	14.020	6	32.100	9043600321000

## Module 4x4 shrink fit chuck flange

### Product information

- for the highly accurate radial and axial alignment on alignment adaptors or machine spindles
- cooling lubricant without loss and flow-disruption thanks to the use of an intermediate tube
- balancing quality G6.3 / 15,000 rev./min
- for tool shank tolerance h6
- with axial damping screw for optimal concentricity

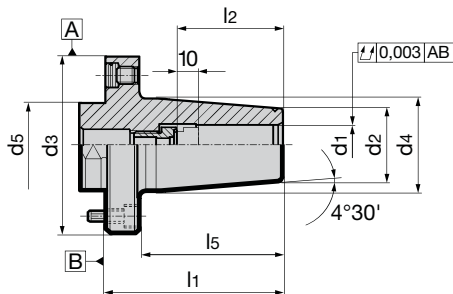

### Scope of delivery

- incl. adjustment screw with axial force
- damping Series no. 4941
- incl. angular alignment seten Series no. 4715
- incl. 4 clamping screws
- order intermediate tube Series no. 4716 separately
- further dimensions on request



Series no. **4760**

Module- $\varnothing$ d3 mm	for shank $\varnothing$ d1 h6 mm	d2 mm	d4 mm	d5 mm	l1 mm	l2 mm	l5 mm	incl. setting screw art. no. 4941	intermediate sleeve tube art. no. 4716	Code no.	EDP Number
60	6	21	27	30	70	36	56	6.100	14.010	6.060	9047600060600
60	8	21	27	30	70	36	56	8.100	14.010	8.060	9047600080600
60	10	24	32	30	70	40	56	10.100	14.020	10.060	9047600100600
60	12	24	32	30	70	45	56	12.100	14.030	12.060	9047600120600
70	12	24	32	35	75	45	60	12.100	14.020	12.070	9047600120700
70	14	27	34	35	75	45	60	14.100	14.020	14.070	9047600140700
70	16	27	34	35	75	48	60	16.100	14.040	16.070	9047600160700
80	18	33	42	40	80	48	65	18.100	14.050	18.080	9047600180800
80	20	33	42	40	80	50	65	20.100	14.040	20.080	9047600200800
100	25	44	52	50	80	56	61	25.100	20.010	25.100	9047600251000
100	32	44	52	50	80	60	61	32.100	20.020	32.100	9047600321000

HOLDERS for  
fine machining

**Product information**

- for the highly accurate radial and axial alignment on alignment adaptors or machine spindles
- suitable for MQL and conventional cooling
- for the transferable torsional moment the interface between spindle and flange has to be taken into consideration
- for holding HSK-A/C shanks to ISO 12164-1/DIN 69893

**Scope of delivery**

- incl. MQL 4-point clamping set Series no. 4930
- incl. clamping screw Series no. 4935
- incl. brass lock ring Series no. 4953
- incl. 6 angular alignment sets Series no. 4715
- incl. 6 clamping screws
- incl. intermediate tube Series no. 4716

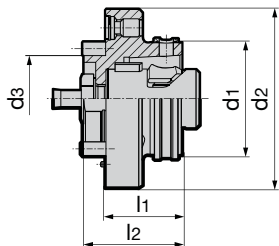

Series no. **4713**

HSK-C d <sub>1</sub> mm	Module-Ø d <sub>2</sub> mm	d <sub>3</sub> mm	l <sub>1</sub> mm	l <sub>2</sub> mm	intermediate sleeve tube art. no. 4716	Code no.	EDP Number
32	60	30	26	36	24.060	24.060	9047130240600
40	70	35	30	40	30.070	30.070	9047130300700
50	80	40	35	45	238.080	38.080	9047130380800
63	100	50	43	55	48.100	48.100	9047130481000
80	117	60	50	62	60.117	60.117	9047130601170
100	140	80	75	87	75.140	75.140	9047130751400

Length adjustment screw for conventional cooling

**Product information**

- to adapt MQL tool holders to meet the requirements of conventional wet machining. For plain end shanks. The height of screw head compensates the height of MQL taper

- for MQL HSK-A shrink fit and hydraulic chucks
- for use with shank according to DIN 6535 with plain shank end for conventional cooling
- with the patented face orientated O ring axial force damping is provided which prevents concentricity errors.

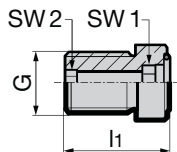

Series no. **4941**

for HSK-A	clamping- Ø	G	d <sub>1</sub> mm	l <sub>1</sub> mm	SW1	SW2	Code no.	EDP Number
40	6	M5	6.0	14.9	2.5	-	6.0400	9049410060400
40	6	M7x1	5.8	15.0	2.5	-	6.0410	9049410060410
40	8	M7x1	5.8	18.0	3	-	6.0500	9049410060500
50	6	M8x1	5.8	14.0	2.5	-	6.1000	9049410061000
50	8	M8x1	6.8	18.0	3	-	8.0400	9049410080400
40 / 50	10	M8x1	9.8	17.7	4	-	8.0500	9049410080500
63/ 80/ 100	6	M10x1	5.8	17.0	2.5	-	8.1000	9049410081000
63/ 80/ 100	8	M10x1	7.8	17.0	3	-	10.0500	9049410100500
63/ 80/ 100	10	M10x1	9.8	16.2	4	-	10.1000	9049410101000
40/ 50/ 63/ 80/ 100	12	M10x1	9.8	16.0	5	-	12.1000	9049410121000
40/ 50/ 63/ 80/ 100	14	M10x1	9.8	17.2	5	-	14.1000	9049410141000
50/ 63/ 80/ 100	16	M12x1	15.8	18.2	6	-	16.1000	9049410161000
50/ 63/ 80/ 100	18	M12x1	15.8	19.2	6	-	18.1000	9049410181000
50/ 63/ 80/ 100	20	M16x1	15.8	19.2	6	8	20.1000	9049410201000
63/ 80/ 100	25	M16x1	15.8	22.7	6	8	25.1000	9049410251000
63/ 80/ 100	32	M16x1	15.8	26.7	6	8	32.1000	9049410321000

Holders for fine machining

## Intermediate sleeves for module flange and alignment adaptor 6x6 and 4x4

### Product information

- for sealing when machining with either coolant or MQL
- Design without O-ring for HSK module adaptor flange art. no. 4363 and art. no. 4713

### Scope of delivery

- with O-ring and sealing lip
- Series no. 4617 1.140

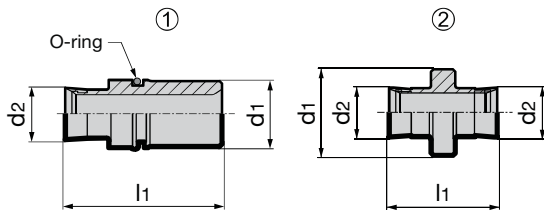

Series no. **4716**

d <sub>1</sub> mm	for d <sub>2</sub> mm	l <sub>1</sub> mm	O-ring	type	Code no.	EDP Number
14	10.5	47.5	10x1.5	1	14.01	9047160140100
14	10.5	32.0	10x1.5	1	14.02	9047160140200
14	10.5	37.5	10x1.5	1	14.03	9047160140300
14	10.5	26.5	10x1.5	1	14.04	9047160140400
14	10.5	31.5	10x1.5	1	14.05	9047160140500
20	10.5	28.0	17x1.5	1	20.01	9047160200100
20	10.5	25.5	17x1.5	1	20.02	9047160200200
20	10.5	16.5	17x1.5	1	20.03	9047160200300
4	10.5	26.1	-	1	24.060	9047160240600
5	10.5	21.9	-	1	30.070	9047160300700
6	10.5	21.9	-	1	238.080	9047162380800
7	10.5	31.7	-	1	48.100	9047160481000
10	10.5	28.6	-	1	60.117	9047160601170
12	10.5	36.4	-	1	75.140	9047160751400
17.8	10.5	22.3	-	2	60.100	9047160601000
17.8	10.5	26.3	-	2	117.140	9047161171400

## Angle alignment units for module flange and alignment adaptor 6x6 and 4x4

### Product information

- for accurate angle alignment of module flanges

### Scope of delivery

- pressure disc, threaded pin and snap ring

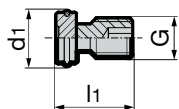

Series no. **4715**

for module	G	d <sub>1</sub> mm	l <sub>1</sub> mm	Code no.	EDP Number
60 / 70 / 80	M8x1	11.5	13	8.01	9047150080100
100 / 117 / 140	M10x1	13.6	19	10.01	9047150100100

HOLDERS FOR  
 FINE MACHINING



Holder for fine machining

PRECISION  
IS A MATTER OF SETTING!



**QUICK + SIMPLE  
ADJUSTMENT**



**AXIAL + RADIAL  
 $\mu$ -ACCURATE SETTING**



**CONCENTRICITY AND  
ALIGNMENT ERROR  
COMPENSATION**



**MQL SUITABLE**

